

Chapter

Effects of Biodiesel Blends Varied by Cetane Numbers and Oxygen Contents on Stationary Diesel Engine Performance and Exhaust Emissions

Semakula Maroa and Freddie Inambao

Abstract

This work investigated waste plastic pyrolysis oil (WPPO), 2-ethyl hexyl nitrate (EHN), and ethanol as sources of renewable energy, blending conventional diesel (CD), WPPO, and ethanol with EHN was to improve the combustion and performance characteristics of the WPPO blends. EHN has the potential to reduce emissions of CO, CO₂, UHC, NO_x, and PM. Ethanol improves viscosity, miscibility, and the oxygen content of WPPO. Mixing ratios were 50/WPPO25/E25, 60/WPPO20/E20, 70/WPPO15/E15, 80/WPPO10/E10, and 90/WPPO5/E5 for CD, waste plastic pyrolysis oil, and ethanol, respectively. The mixing ratio of EHN (0.01%) was based on the total quantity of blended fuel. Performance and emission characteristics of a stationary 4-cylinder water-cooled diesel Iveco power generator were evaluated with ASTM standards. At 1000 rpm, the BSFC was 0.043 kg/kWh compared to CD at 0.04 kg/kWh. Blend 90/WPPO5/E5 had the highest value of 14% for BTE, while the NO_x emissions for 90/WPPO5/E5, 80/WPPO10/E10, and 70/WPPO15/E15 were 384, 395, and 414 ppm, respectively, compared to CD fuel at 424 ppm. This is due to their densities of 792 kg/m³, 825 kg/m³ which are close to CD fuel at 845 kg/m³ and the additive EHN. These results show blends of WPPO, ethanol and EHN reduce emissions, and improve engine performance, mimicking CD fuel.

Keywords: 2-ethyl hexyl nitrate, ethanol, oxygen content, ignition quality, waste plastic pyrolysis oil, cetane index

1. Introduction

Diesel engines the world over are the major power source in the automobile transport industry and nonroad powered engines. However, because of the issue of pollution associated with diesel exhaust, particularly particulate matter (PM) and nitrogen oxide (NO_x), there has been increasingly stringent regulation to control the manufacture and use of diesel engines. This has led to extensive research on improving diesel engines and fuel [1, 2]. The use of alternative fuels tops the list of measures to control diesel exhaust emissions as recommended by researcher [3]. Besides the use of alternative fuel to control and reduce emissions, other control

strategies such as exhaust gas recirculation (EGR), diesel particulate filters (DPF), selective catalytic reduction (SCR), and catalytic converter combinations have been recommended but not as stand-alone technologies [4, 5].

The transport industry and nonroad diesel engines are major contributors to global gross domestic product. Nevertheless, their use affects human health and degrades the environment. The transport industry is responsible for one third of all environmental emissions of volatile organic compounds (VOCs), including two thirds of carbon monoxide (CO) emissions [6]. Carbon dioxide (CO₂) is a primary cause of global warming with 34 billion tons per year or 22% of all the global emissions per year [7], with a projected increase in 3% annually since 2011. This is projected to rise to 41 billion tons of CO₂ emissions by the year 2020 [8, 9]. Diesel engines release emissions, which lead to poor air quality, acid rain, smog, haze, and climate change. These factors increase the global disease burden due to respiratory system diseases and cancer [10].

The soluble organic fraction (SOF) and volatile organic fraction (VOF) are mainly due to exhaust dilution and the cooling process from fuel or evaporating lubricating oil, due to the process of oxidation. The control of VOC emissions is with high-pressure injection system catalytic converters and positive crankcase ventilation systems. The PM emissions of VOCs arising from evaporating lubrication oil and incomplete combustion have a combined emission rate of 0.06–2.2 g/bkWh for light diesel (LD) engines compared to heavy diesel (HD) engines at 0.5–1.5 g/bkWh [11, 12]. The condensation of oxidized and pyrolyzed products of fuel molecules is the leading cause for the formation of PM emissions composed of the nucleation and accumulation modes [13]. In emerging economies, air pollution is the leading cause of thousands of premature deaths estimated at 2.4 million annually by 2009 estimates [14]. Besides the usual toxics emitted by stationary and nonroad engines, diesel engines emit toxics such as formaldehyde, acrolein, acetaldehyde, and methanol. Exposure to these toxic emissions causes eye, skin, and mucous membrane irritation, besides affecting the nervous system. Therefore, the need for environmental protection has played a role in bringing together relevant stakeholders and government agencies. These agencies include the WHO, the Organization of Economic Cooperation and Development (OECD), the Inter-Governmental Panel on Climate Change (IPCC), the Environmental Protection Agency (EPA), the European Environmental Agency (EEA), and the International Energy Agency (IEA). For example, the USA government through the EPA has established the Reciprocating Internal Combustion Engine (RICE) rules, which cover stationary and nonroad engine emission regulations [15]. These rules are out of the scope of this chapter, but future work will discuss them in line with other European Union rules [16] and other global adopted emission regulations.

In order to meet modern requirements, diesel engines are designed with complex contrary goals to operate optimally in stationary and mobile operations. This requires high torque, low emissions, and high efficiency engines. For this reason, auxiliary diesel engine components such as turbochargers, EGR, and high-pressure injection systems are utilized today. These auxiliary parts are grouped into engine operating subsystems such as air, combustion, injection, and mechanical units to meet these operating demands. Since fuel is a major determinant in engine combustion and emission characteristics, the use of alternative fuel is being encouraged as a strategy to reduce emissions. The combustion of alternative fuel is different from the combustion of diesel, which is a fossil fuel, but they too cause emission problems as has been reported in a number of studies [17, 18]. To mitigate these problems, researchers have come up with combustion control strategies such as:

- homogeneous charge compression ignition (HCCI) [19, 20];
- pre-mixed charge compression ignition (PCCI) [21, 22];

- reactivity charge compression ignition (RCCI) [23]; and
- variant strategies to deal with emissions [24–30].

Modern day passenger vehicles and stationary engines are now evaluated using driving cycles such as the New European Driving Test Cycle (NEDC) and the Federal Test Procedure (FTP) mostly as bench operated chassis dynamometer tests [31]. However, it should be remembered that at engine start conditions, after-treatment techniques report poor performance as most of them operate with catalysts that are light-off temperature dependent. At ambient temperature, most catalysts cannot attain the light-off temperature when engines are started and operated. Since the year 2000 when EURO III was implemented, the NEDC procedure has been modified to eliminate the 40 s warm up before emission sampling can take place [32]. The new development initiative for diesel exhaust emission has already been established in the United States and Japan. The last decade has seen the European Union implementing similar standards and procedures, with the rest of the world expected to also implement changes as globalization and interdependency grows. A number of requirements have been implemented in the United States to nominally reduce 85–90% of NO_x , while for the Euro VI (2014), an additional reduction 65–70% of NO_x to match the US standards has been accepted as shown in **Figures 1** and **2** [33].

The combustion of diesel fuel depends on several factors that affect engine geometry, fuel properties, compression temperatures (especially of the combustion mixture), injection strategy applied, and the existing condition of the ambient temperatures as reported by the authors of Refs. [34, 35]. High cetane number additives together with the development of high volatility fuels [36, 37] have boosted diesel engine performance. The oxygenated additives in biodiesel blend components improve the combustion process, especially the octane rating. Additionally, oxygenated additives enhance and increase the cetane number. In other words, the oxygen in the additives supports the combustion of the fuel while at the same time reducing inert material such as NO_x formation in CI engines. These changes deal with the complexities of cold start, which impede engine starting at lower or subzero engine temperatures. Warm engines have a starting time delay of 1–2 s at ambient temperature conditions, compared to a low ambient temperature start-up time of 10 s [38, 39].

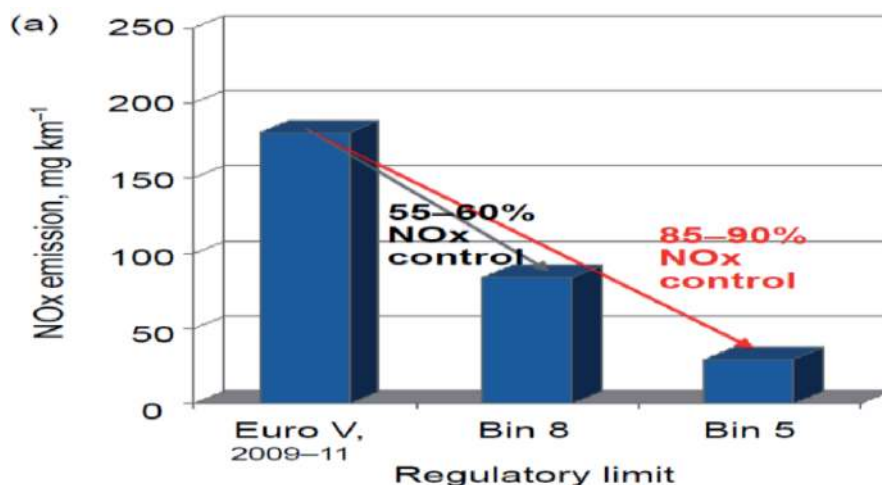

Figure 1. Requirement to reduce about 55–60% of NO_x emissions for Euro V (2009) diesel to match the US Bin 8 maximum allowable emission in 45 US states [33].

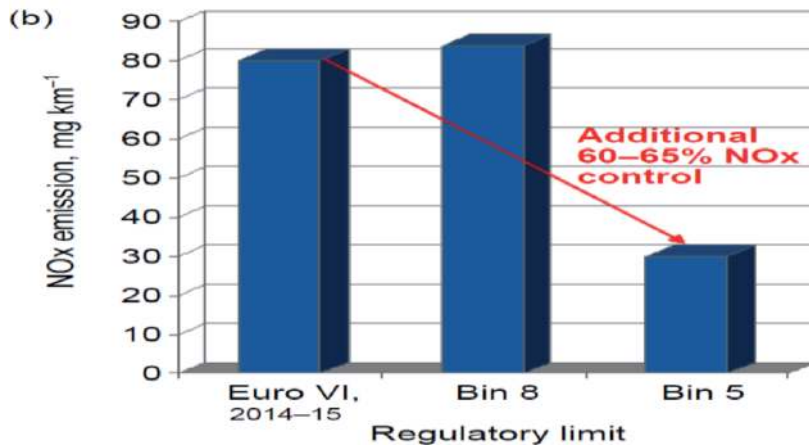

Figure 2.
Variation of NOx emission with the regulatory limit for 45 US states [33].

2. Regulatory development in diesel engine emission

Stringent diesel exhaust emission regulatory policies have been in operation in the United States and Japan since 2005. The European Union has also responded with additional emission regulatory standards called the EURO VI since 2014. Apart from these regulatory controls, there are market and political pressures on automobile manufacturers to continue to improve on efficiency while reducing emissions. These factors have been the driving force behind the significant technological progress in engine research and the transport industry in the past two decades.

2.1 Heavy duty diesel regulatory developments

The European Union commission on emissions in 2014 stipulated that the nominal NO_x emission limit must be 0.20 g/kWh⁻¹ and the PM emission level must be 0.010 g/kWh⁻¹. This matched the US 2010 emission regulation, which put the emission limits at 0.26 g/kWh⁻¹ for NO_x and 0.013 g/kWh⁻¹ for PM emissions. The Japanese emissions regulation of 2009 stipulates 0.7 g/kWh⁻¹ for NO_x emissions and 0.010 g/kWh⁻¹ for PM emissions. However, it must be mentioned here that each of these countries propose a different transient testing cycle.

The European Union commission on pollution and emission has adopted a new world harmonized transient cycle (WHTC) that uses higher load and speed than the Japanese and American standards. Additionally, the European commission on emissions has set standards related to number-based PM standards with heavier in-use compliance measures as illustrated in **Figure 3**, by 2012. These measures are aimed at improving fuel economy and durability and lowering the cost of manufacturing and maintenance. The development in this segment is muted, mixed with conservatism and pragmatism. For example, the development in HD since 2004 has seen the US regulations matched and addressed through advanced EGR and intake charge boosting measures. However, later development starting from 2005 in Japan and 2007 in the United States has seen additional technologies added to cater for increased regulation. These two markets introduced diesel particulate filters (DPFs) to match the change in policy and regulation in the European Union with implementation of EURO V-VI emission regulations. This policy shift and regulation change has witnessed conventional engine technology adding the selective catalytic

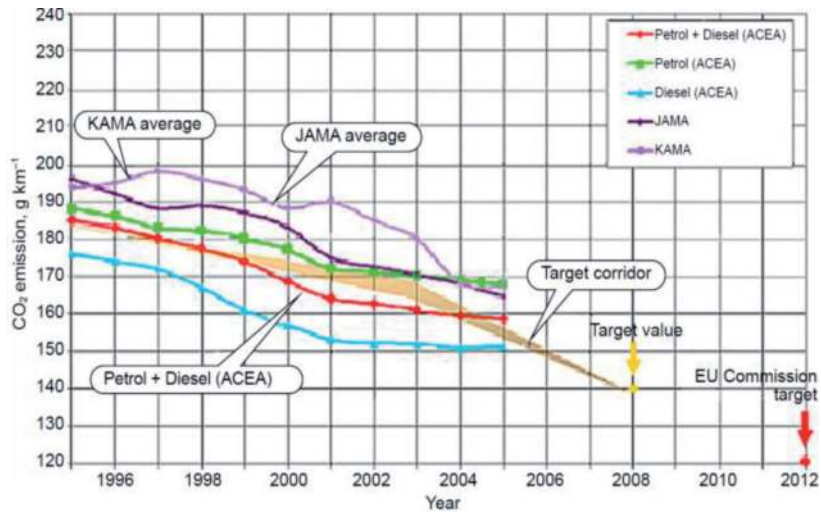

Figure 3. Progress toward meeting the European Union voluntary CO₂ limits of the European Automobile Manufacturers Association (ACEA), Japan Automobile Manufacturers Association (JAMA), and Korea Automobile Manufacturers Association (KAMA) (courtesy of Daimler Chrysler) [40].

reduction (SCR) system in the fight against emission. Since 2009 and 2010, respectively, Japan and the United States have added significant incremental advances in emission compliant technologies, especially technologies that target low load emissions in HD engines. Researchers working on the traditional diesel combustion hardware and strategies are directing more effort to reduce LD engine category emissions with the future looking bright.

2.2 Light duty diesel regulatory development

Modern diesel engine development is driven by regulatory, market, and fuel efficiency demand. In addition, developments in spark ignition (SI) gasoline engines, electric vehicles, and new concepts in hybrid vehicles have had tremendous competitive pressure on diesel engine development, especially in the LD category. Diesel engine manufacturers are responding with the introduction of advanced fuel injection technology, exhaust gas recirculation (EGR) techniques,

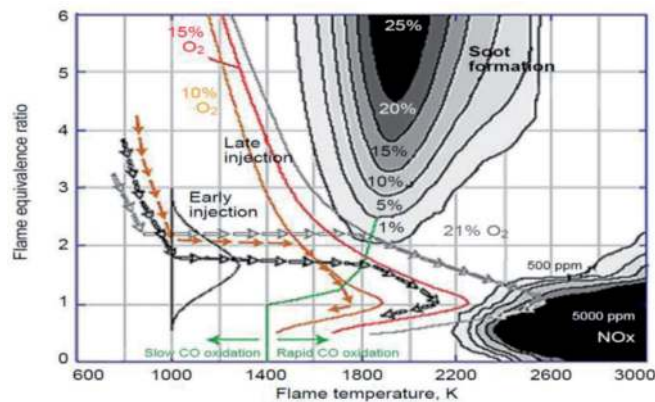

Figure 4. Variation of flame equivalence ratio, temperature, and injection strategies and principles of advanced combustion (courtesy of Sandia National Laboratory) [44, 45].

two-stage turbocharging, variable valve actuation, closed loop combustion control, and advanced model-based controls. Development in advanced diesel engines has now achieved a specific output of 70 kW^{-1} and a brake mean effective pressure (BMEP) of 24 bars [41], hence meeting EURO VI emission standards [42, 43] as shown in **Figure 4**.

3. Control strategies for emissions in diesel engine

The world is now aware of the environmental and human health costs of pollution from diesel engines, which form the bulk of commercial and personal public transport systems. **Table 1** shows that there is an increase in the regulatory measures on toxic gas emissions. These regulations oblige vehicle manufacturers and transport industry service providers to be motivated to work harder to meet the appropriate standards and regulations. Among the techniques that have been employed to cut down on emissions are EGR, LNT, DOC, DPF, and SCR [46, 47]. However, there is no single method that meets emission standards by the regulatory bodies on vehicular emission.

3.1 Exhaust gas recirculation (EGR)

This is one of the most useful and successful techniques in the control of and fight against diesel exhaust emissions. EGR allows the recirculation of part of the diesel exhaust into the combustion chamber, to reburn together with the fresh intake charge [49] as shown in **Figure 5**.

This technology has been able to reduce NO_x emissions, but it causes an increase in UHC and CO emissions as compression temperatures decrease. It also affects engine thermal efficiency as shown in **Figure 6**. This technique has two methods for quantification of EGR flow rate, although there is no single method that is universally accepted. The two methods are the mass method and the gas concentration method [5]. These two methods are demonstrated in **Figure 5** and expressed in Eqs. (1) and (2):

$$r_{EGR} = \frac{\dot{m}_{EGR}}{\dot{m}_{air} + \dot{m}_f + \dot{m}_{EGR}} \quad (1)$$

$$\frac{[CO_2]_{int} - [CO_2]_{amb}}{[CO_2]_{exh} - [CO_2]_{amb}} \approx \frac{[CO_2]_{int}}{[CO_2]_{exh}} \quad (2)$$

where the \dot{m}_{EGR} is the mass flow rate of the gas recirculated, \dot{m}_{air} is the mass flow rate of fresh air, \dot{m}_f is the mass flow rate of the injected fuel, and r_{EGR} is the mass fraction of the recirculated exhaust gases. $[CO_2]_{int}$ is the carbon dioxide at the intake side, $[CO_2]_{amb}$ is the ambient carbon dioxide, $[CO_2]_{exh}$ is the exhaust carbon dioxide (exit carbon dioxide).

3.2 The low NO_x trap (LNT)

This system is also known as NO_x storage reduction (NSR) and NO_x absorber catalyst (NAC). It has three main components, namely, the oxidation catalyst with platinum (Pt), the NO_x storage with barium (Ba), and the reduction catalyst with rhodium (Rh). The platinum catalyst is preferred as it reduces NO_x emissions at very low temperatures while offering a stable reaction in the presence of sulfur and H_2O [51, 52]. **Figure 7** shows the LNT three-stage catalytic process.

STD type	CO g/kWh	HC g/kWh	NO _x g/kWh	PM g/kWh
Euro I	4.5	1.1	8.0	0.61
Euro II	4	1.1	7.0	0.15
Euro III	2.1	0.66	5.0	0.13
Euro IV	1.5	0.46	3.5	0.02
Euro V	1.5	0.46	2.0	0.02
Euro VI	1.5	0.13	0.4	0.01

Table 1.
 EURO standards for heavy-duty vehicles according to Delphi 2016–2017 as per Ref. [48]

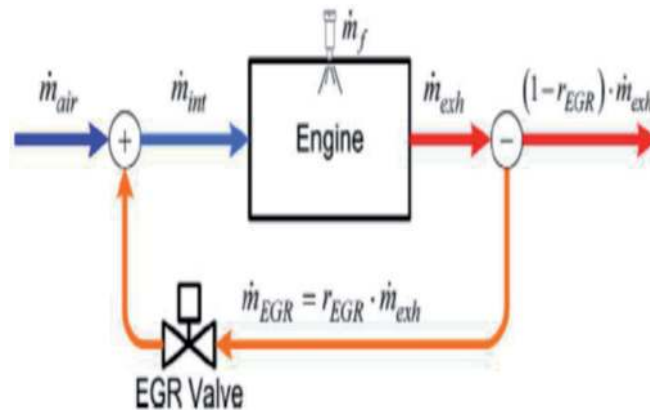

Figure 5.
 EGR system nomenclature and control design for the EGR valve [4].

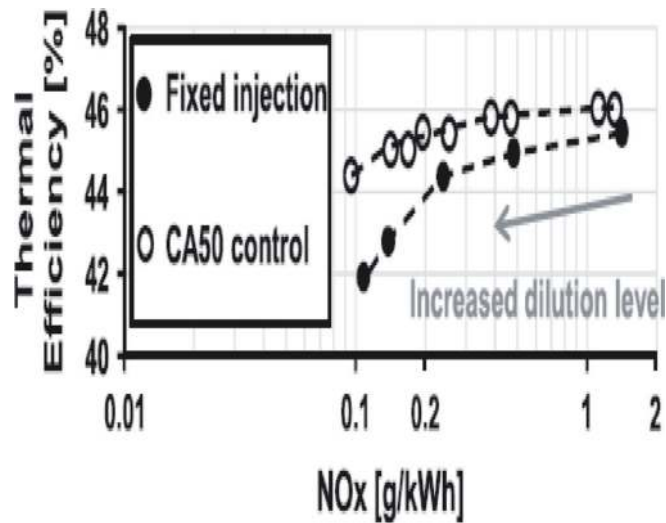

Figure 6.
 Variation of engine thermal efficiency and NO_x with the influence of EGR dilution [50].

3.3 The selective catalyst reduction (SCR)

This is one of the most recent technology developments introduced for the control of diesel exhaust emissions. This system was originally introduced to cater for HD engines [53], but Audi and Volkswagen have also adopted it for their

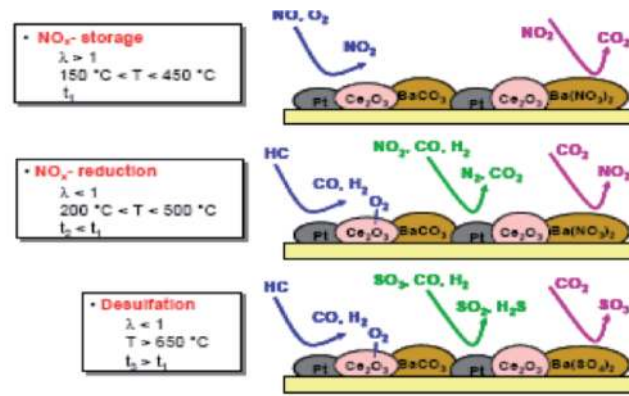

Figure 7.
The low NO_x trap (LNT) with three of its operating modes [53].

passenger vehicle and LD segments. The SCR system works by utilizing ammonia as a reductant in order to minimize NO_x emissions in the diesel exhaust by releasing N₂ and H₂O. This system therefore undergoes two processes during the working cycle, namely, hydrolysis and thermolysis as in Eqs. (3) and (4) for hydrolysis and thermolysis, respectively [54, 55].



In addition to the two processes of hydrolysis and thermolysis, SCR undergoes other chemical reactions to complete its normal cycle, thus reducing the emissions of NO_x further as in Eqs. (5)–(7). **Figure 8** shows a schematic diagram of an SCR system showing the oxidation catalyst, wall flow particulate filter, and the flow through the SCR catalyst. **Figure 8** also includes key components of a urea solution tank, a spray module, a static mixer, temperature, and NO_x sensor, courtesy of Robert Bosch GmbH [46].

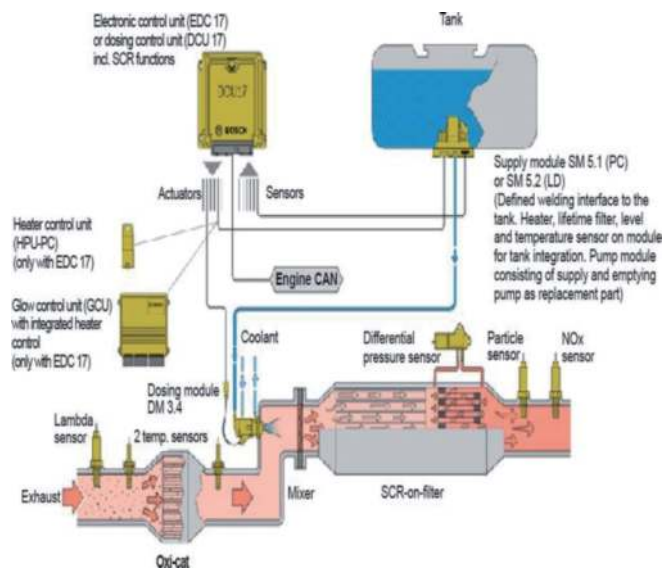
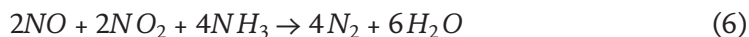
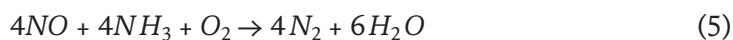

Figure 8.
Schematic diagram of the SCR NO_x control system as used in a standard production vehicle [46].



3.4 Diesel particulate filter (DPF)

The DPF filter requires care to avoid excessive saturation and build-up of backpressure, both of which are harmful for engine operation and durability and increase fuel consumption and engine stress levels leading to premature failure of the filter and engine. DPF systems have been in operation in diesel exhaust emission control since the year 2000, primarily for removing PM emissions through physical filtration. DPFs are like a honeycomb with silicone carbide or cordierite written chemically as $2MgO - 2Al_2O_3 - 5SiO_2$. Both ends of the structure are blocked to force the particulate matter through the porous substrate walls, thus acting as a mechanical filtering system. These walls are made such that they offer little or no resistance to flow of exhaust gases while maintaining the power to collect particles [56] as shown in **Figure 9**.

3.5 Diesel oxidation catalyst (DOC)

The DOC is manufactured with the sole purpose of reducing CO and UHC emissions through oxidation of the hydrocarbons that are absorbed into the carbon particles. The DOC consists of a metal or a ceramic structure with an oxide mixture also called the wash coat that contains aluminum oxide (Al_2O_3), cerium oxide (CeO_2), zirconium oxide (ZrO_2), and an active metal catalyst of either platinum, palladium, or rhodium [54], as shown in **Figure 10**. For HD and LD vehicles in Europe, the United States, and Japan, the DOC is the after-treatment emission control systems of choice. The DOC with a platinum metal catalyst is the most popular among manufacturers and consumers. However, the DOC has the disadvantage of reacting with sulfur oxide and sulfur trioxide producing sulfates and sulfuric acid,

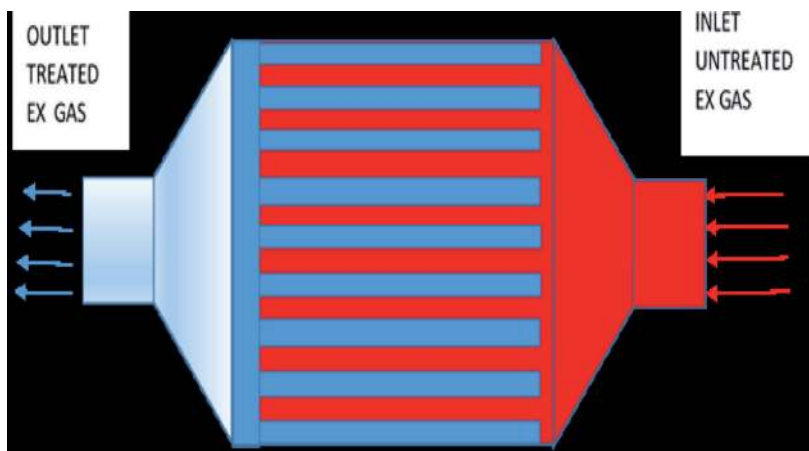

Figure 9. Schematic of the working mechanism of a diesel particulate filter (DPF) [6].

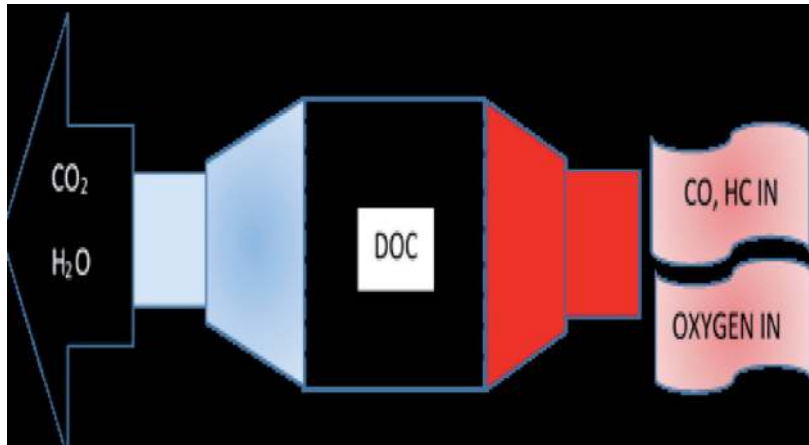

Figure 10. Schematic diagram of a DOC and its operation in reducing emissions of CO and UHC through the process of oxidation [6].

which shortens the service life of the emission control system besides the additional effects on the natural environment and human health.

Six factors affect and influence the choice of a DOC filter:

- conversion factor;
- temperature stability;
- light-off temperature;
- tolerance to poisoning;
- cost of manufacturing the filter; and
- parametrical factors, including the density of the DOC filter measured in channels per square inch, the cross-sectional area, the channel wall thickness, and the length of the channels using the external dimensions [57, 58].

4. Methodology and experimental set-up

This experiment is making a case for blending of WPPO whose n-alkenes are lower by 25% in auto-ignition, compared to diesel fuel whose n-alkenes are good for auto-ignition. The aromatics, which affect PM emissions, are very low in WPPO blends. According to Refs. [59, 60], WPPO consists of iso-alkanes, n-alkanes, and olefins in the region of 27, 25, and 9%, respectively, with over 30% content being undefined due to complicated and complex chemical bond structures. However, aromatic cyclo-alkanes (naphthalene) and aromatics poor in auto-ignition were also found to be 40% by volume [61]. Blending was preferred to improve the low pour point to improve the cold starting characteristics of WPPO. Second, blending with ethanol was introduced to improve the fuel spray characteristics; ethanol is soluble and miscible in WPPO blends. Third, blending contributed to the reduction of the viscosity of WPPO biodiesel, thus further improving spray characteristics.

4.1 Engine tests

The experiment used a naturally aspirated four-cylinder diesel engine power generator, water cooled, direct injection, Iveco engine, in the Mechanical Engineering Department Laboratory, University of Kwazulu-Natal in Durban, South Africa. Using a defined flow rate of particles, PM emissions were detected by photoelectric measurement. Both the mass flow of the PM particles and the fuel were calculated as the sum of inlet air and fuel mass flow rate, and the result expressed in gram per kWh. To help in the analysis of the engine, pressure sensors and crankshaft position sensors and encoders were used. The aim of these sensors was to provide the in-cylinder pressure in relation to the crankshaft position variation.

Parameters	Position value
Ignition type	4 (Stroke)DICI
Number of cylinders	4 in-line
Cooling medium	Water
Manufacturer	Iveco
Revolutions per minute	2000
Brake power	43.40 kW @ 2000
Cylinder bore	104 mm
Piston stroke	115 mm
Compression ratio	17:1
Connecting-rod length	234
Engine capacity	2500 cc
Dynamometer make	234
Injection timing	12°bTDC
Maximum torque	206.9 Nm @ 1500
Injection pressure	250–272 Bar

Table 2.
Experimental engine specifications.

Property	Equipment	Standard
Kinematic viscosity	SVM 4000 (Anton Paar, UK)	ASTM D445
Flash point	NPM 550 (Norma lab, France)	ASTM D93
Oxidation stability	900 Rancimat (Metrohm, Switzerland)	ASTM D14112
CP/PP	NTE 500 (Norma lab, France)	ASTM D2500
Carbon residue	NMC 440 (Norma lab, France)	ASTM D4530
Total sulfur	5000 MULTI-EA (AJ Germany)	ASTM D5433
Calorific value	C 2500 basic calorimeter (IKA, UK)	ASTM D240
Density	SVM 3500 (Anton Paar, UK)	ASTM D1298
PM	AVL smoke meter	—
Gaseous emissions	Gas analyzer (MEXA 7000) Germany	—

Table 3.
List of equipment used in the experiment.

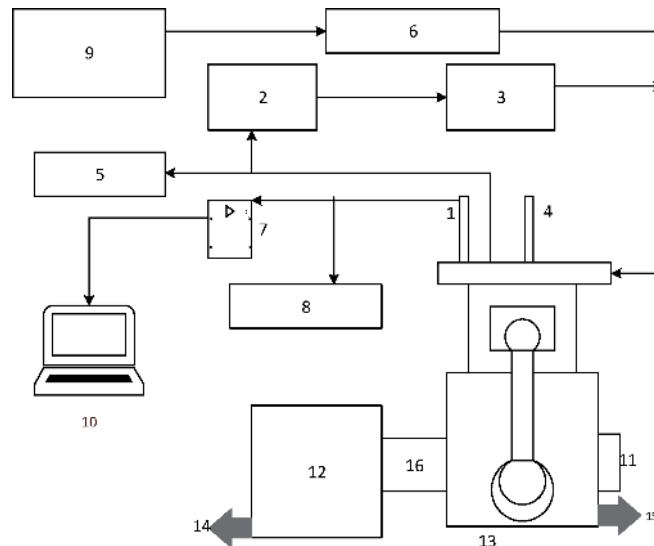

Figure 11. Schematics of the test engine set up rig: (1) cylinder pressure sensor; (2) EGR control valve; (3) EGR cooler; (4) injection control unit; (5) exhaust gas exit; (6) air box; (7) signal amplifier; (8) gas analyzer; (9) air flow meter; (10) data acquisition system; (11) crank position sensor; (12) dynamometer; (13) engine; (14) cooling water exit from the dynamometer to the cooling tower; (15) cooling water exit from the engine to the cooling tower; and (16) dynamometer drive coupling.

The engine was coupled to a mechanical dynamometer with engine idling positions divided into two engine speed modes. The two speed modes were set at 500 and 1000 rpm as Mode 1, and Mode 2 as 1500 rpm and full load at 2000 rpm. The details of the engine and specifications and equipment are described in **Tables 2** and **3**. **Figure 11** shows a schematic of the engine test setup.

4.2 Physicochemical property analysis

WPPO by pyrolysis was obtained from a commercial plant whose production chart is shown in **Figure 12**. Ethanol, conventional diesel, and EHN were purchased

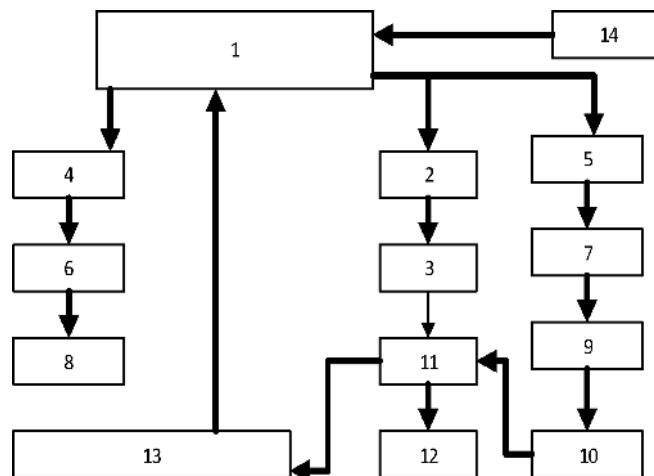

Figure 12. Pyrolysis plant flow chart and its nomenclature: (1) pyrolysis reactor; (2) carbon black discharge; (3) carbon black deep processing; (4) exhaust smoke discharge; (5) gas separator; (6) smoke scrubber to take out color and odor; (7) condenser; (8) chimney; (9) oil tank; (10) synchronized gas purification; (11) synchronized gas-recycling system; (12) extra gas burning; (13) heating furnace during operation; and (14) loading of material.

Properties	Unit	CD	WPPO	Ethanol
Density @ 20°C	kg/m ³	845	825	792
Visc.@ 40°C	cSt	3.04	2.538	1.05
Cetane number	—	55	—	8.5
Flash point	°C	50	43	16
Fire point	°C	56	45	53
Carbon residue	%	22	0.015	—
Sulfur content	%	<0.028	0.248	—
Gross calories	kJ/kg	46500	43340	29700
Cetane index	—	46	65	—

Table 4.
 Properties of diesel, WPPO, and ethanol before blending and addition of EHN.



Figure 13.
 The distillate samples from the waste plastic pyrolysis oil samples.

Property	Unit	CD	90/5/5	80/10/10	70/15/15	60/20/20	50/25/25	STANDARD
Density	Kg/m ³	845	838.5	834	830	825	823	ASTM D1298
Viscosity @ 40	cST	3.452	2.38	2.37	2.365	2.340	2.325	ASTM D445
Cetane number	-	45	59	62	64	65	69	ASTM D4737
GCV	kJ/kg	44840	41245	39985	38700	36800	34500	ASTM D4868
Sulfur content	%	<0.0124	0.0248	0.0249	0.0251	0.0253	0.0257	ASTM D4294
Oxygen	%	12.35	13.80	14.75	15.15	16.25	17.35	ASTM D5622
Carbon residue	%	74.85	75.35	76.40	77.55	78.25	79.65	ASTM D 7662
Flash point	°C	56.5	38.5	37.55	37.35	37.15	36.85	ASTM D93
Hydrogen	%	12.38	7.5	7.55	7.65	7.75	7.95	ASTM D7171

Table 5.
 Properties of blended ratio mixtures of diesel, ethanol, WPPO with EHN.

from local outlets and blended using a homogenizer for 5 min at 3000 rpm. The properties of all samples were measured in the Chemical Engineering Laboratory of the University of Kwazulu-Natal in Durban, South Africa. **Table 3** shows some important physicochemical properties of the fuels before blending. **Table 4** shows physicochemical properties of fuels and their determined fuel properties after blending. **Figure 13** is a photograph of the sample distillates of WPPO obtained from pyrolysis. **Table 5** is showing properties of blended ratio mixtures of diesel, ethanol, WPPO with EHN.

5. Experimental results and discussion of diesel engine emissions

5.1 Brake-specific fuel consumption (BSFC)

Figure 14 is a variation in brake-specific fuel consumption (BSFC) with engine speed. The BSFC compared to the engine speed in **Figure 14** shows that as the speed increased, there is an equal increase of fuel consumed by the test engine. The values obtained at full engine speed (2000 rpm) for the blends of 90/WPPO5/E5, 80/WPPO10/E10, 70/WPPO15/E15, 60/WPPO20/E20, 50/WPPO25/E25, and CD were 0.04 kg/kWh, 0.041 g/kWh, 0.042 kg/kWh, 0.043 kg/kWh, and 0.035 kg/kWh, respectively.

At high engine speeds, the conversion of heat energy to mechanical energy increases with the increase in combustion temperature, leading to increased BSFC for the biodiesel; this increase is proportional to the difference in their heating values, which is identical to the findings of Ref. [62]. These blends of WPPO compare well to CD fuel and other biodiesel blends with comparative differences in the heating values.

However, from the graph, it is evident that as the blend ratio increases, there is a decrease in the BSFC across all the test fuels. Nevertheless, the values for all WPPO blends were slightly higher than the CD test fuel. The closeness of the values and the packed graph reveals a close resemblance and identical BSFC characteristics of WPPO, ethanol, and EHN compared to CD fuel. For example, at 500 rpm engine speed, the blend of 80/WPPO10/E10 had a value of 0.043 g/kWh compared to full engine speed (2000 rpm) with 0.041 kg/kWh, which is higher than CD test fuel with 0.04 kg/kWh at 1000-rpm engine speed and 0.035 kg/kWh at full engine speed (2000 rpm).

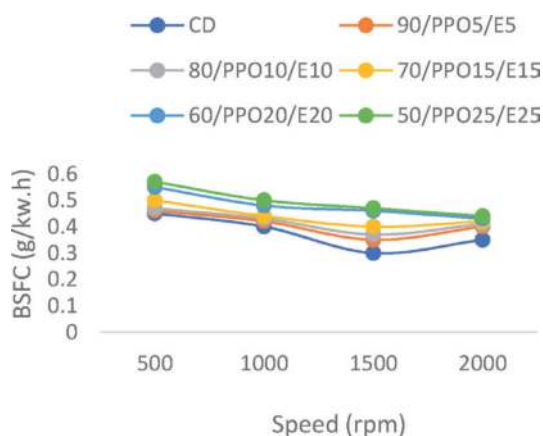

Figure 14.
BSFC versus engine speed.

5.2 Brake thermal efficiency (BTE)

The brake thermal efficiency (BTE) variations with engine speed are shown in **Figure 15**. The graphs show that as the speed increased, there was an increase in the BTE across all the test fuel blends of WPPO and CD up to 1500 rpm. At 1000 rpm engine speed, the values for blends 90/WPPO5/E5, 80/WPPO10/E10, 70/WPPO15/E15, 60/WPPO20/E20, 50/WPPO25/E25, and CD were 22, 21, 20, 18, 16.5, and 22.5%, respectively. As the blend ratio and engine speed increased, there was a decrease in the BTE within the WPPO blends but an increase in BTE across the blends. For example, at 500 rpm engine speed, 90/WPPO5/E5, 80/WPPO10/E10, 70/WPPO15/E15, 60/WPPO20/E20, and 50/WPPO25/E25 had values of 14, 13, 12.5, 11, and 9.5% compared to at 1000 rpm with values of 22, 21, 20, 18, and 16.5%, respectively.

The highest BTE value was 24% by blend 90/WPPO5/E5 at 1500-rpm engine speed compared to any other blend of WPPO, ethanol, and/or EHN. This could be due to the density, which is closer to CD, and the effect of blending, which improved this blend's physico-chemical properties. **Figure 15** shows values of 24.8, 23, 21, and 19%, respectively, for blends 80/WPPO10/E10, 70/WPPO15/E15, 60/WPPO20/E20, and 50/WPPO25/E25. Blend 50/WPPO25/E25 reported the lowest values compared to the other blends. At 500 rpm engine speed, the BTE value was 9.5% compared with full engine speed (2000 rpm) at 19%.

As the engine speed increased above 1500 rpm, the BTE suddenly dropped as the engine approached full engine speed (2000 rpm), as seen in **Figure 15**. There are a number of factors explaining the above results. For example, at this speed, there is a sudden drop of the air fuel ratio as the mixture becomes richer. This leads to incomplete combustion and heat release energy as more carbon molecules escape the combustion process. These increase the dissociation heat losses by the engine, hence a fall in BTE. Additionally, decreased BTE with biodiesel blends could be due to their low calorific value, higher viscosity, high volatility, and poor spray characteristics. These findings are consistent with other studies by the authors of Refs. [63–65].

5.3 Unburnt hydrocarbon (UHC) concentration

Unburnt hydrocarbon (UHC) concentrations largely indicate the quality of the combustion in an internal combustion engine. UHC concentrations are formed from vaporized unburnt hydrocarbon fuel and partially burnt fuel by-products exiting the combustion chamber diesel exhaust system. UHC concentrations are inherently independent of the air fuel ratio of any working engine [6].

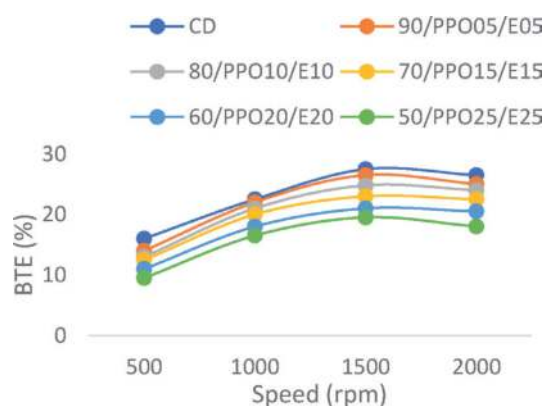

Figure 15.
Brake thermal efficiency versus engine speed.

In compression ignition (CI) engines, UHC concentrations are due to insufficient temperature, especially around the cylinder walls or in pockets. UHC concentrations are also formed through system malfunction, especially in input data failure in modern fuel injection systems. The higher hydrocarbon concentrations may be due to hydrogen radicals in the diesel-ethanol-WPPO-EHN blends. Principally, these concentrations are prevalent during light loads, when the combustion mixture is lean. This period is marked by a lower fuel ratio making the lean fuel-air mixture the primary source of the light load concentrations because of the lack of completion of the combustion during normal engine operating cycles. Hydrocarbon concentrations are not limited to vehicle exhaust systems but can occur in the entire vehicle fuel system from vapors during dispensing and distribution of fuel, which accounts for 15–20%, with the crankcase providing 20–30%. However, diesel exhaust remains the main culprit in engine emissions accounting for 50–60% of all the UHC concentration [66, 67].

Figure 16 shows the variation of UHC emission with engine speed in the stationary diesel power generator using blends of biodiesel. As the engine speed was increased, the UHC concentration increased too. However, the increase was more significant as the engine speed was in intermediate speeds of 1500 rpm moving to or approaching full engine speed (2000 rpm). For example, at 1000 rpm, the values of blends 90/WPPO5/E5, 80/WPPO10/E10, 70/WPPO15/E15, 60/WPPO20/E20, and 50/WPPO25/E25 were 22, 21, 20, 18, and 15 ppm, respectively, compared to full engine speed (2000 rpm) with 35, 34, 32, 29, and 26 ppm. This leads to the conclusion that at high engine speeds, the values of UHC concentration is significantly high for all the blends of WPPO, ethanol, and EHN, although still comparatively low compared to CD fuel.

The UHC concentration from the blends 90/WPPO5/E5 and 80/WPPO10/E10 had higher values although from the graph plot in **Figure 16**, the values are still low compared to the values of CD test fuel. However, the general trend reported by the graph in **Figure 16** shows that as the blend ratio increased, there was a significant reduction in the UHC concentration, observed across all the test fuels irrespective of the engine speed condition, for all the blends tested compared to CD fuel. The reduction in UHC concentration is attributed to the high oxygen content and cetane number of the blends. The high oxygen content supports combustion, while the high cetane number reduces ignition delay. This is identical to other studies by other researchers [68–72].

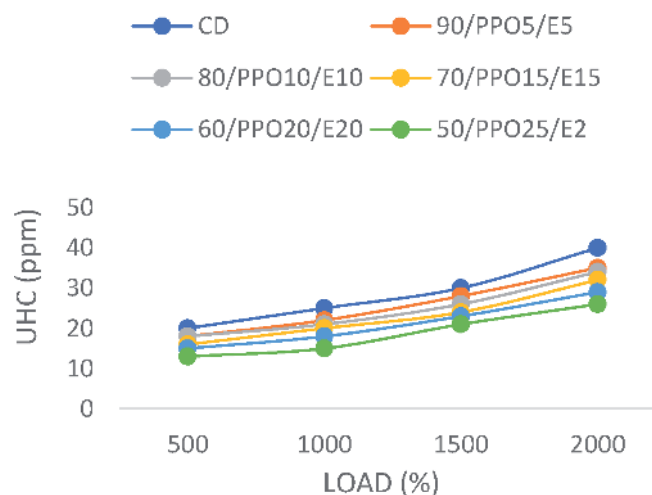

Figure 16. Unburnt hydrocarbons versus engine speed.

The high fraction of ethanol in blends 70/WPPO15/E15, 60/WPPO20/E20, and 50/WPPO25/E25 contributed to the increase in the concentration of UHC, which is identical to the findings of Refs. [73, 74] who observed it in SI engine cylinder walls, crevices, and quenched cylinder walls, especially when richer air-alcohol mixtures were introduced. This type of UHC depends on the following factors: engine adjustments, engine design, and the type of fuel used in an engine. However, the engine-operating environment can sometimes contribute to the type of UHC concentration produced. This is observed especially when the temperature range is 400–600°C in the combustion chamber. At this temperature range, the hydrocarbons continue to experience reaction in the diesel exhaust pipe, thus lowering or increasing the concentration of the UHC in the exiting exhaust gas [75, 76].

5.4 Carbon monoxide (CO) formation

CO concentrations are a direct result of incomplete combustion, which results from hydrocarbons due to the failure of oxidation in the combustion process in diesel engines. This is true especially where the excess air factor λ meets the conditions $\lambda < 1$ for SI engines. Carbon monoxide is a colorless, tasteless, and odorless toxic gas, which is primarily a product of incomplete combustion of carbon containing fuels [6]. The United States is the single largest producer of carbon monoxide from anthropogenic sources as shown in **Figure 17** [77]. Carbon oxidation mechanisms are mostly determined by the equivalence ratio. Carbon monoxide concentrations mainly form in the areas of heavy traffic, parking garages, and under buildings, overheads, and overhangs. CO health effects include headaches and dizziness, but extreme exposure can lead to death.

Figure 18 is the variation of CO with engine speed in a stationary diesel power generator. The graph reveals that as the engine speed and the blend ratio increased 90/WPPO5/E5, 80/WPPO10/E10, 70/WPPO15/E15, 60/WPPO20/E20, and 50/WPPO25/E25, the CO concentration decreased up to 1500 rpm of engine speed. Thereafter, the blends reported a continuous increase as the engine speed was approaching full engine speed (2000 rpm). At 500-rpm engine speed, the blends of 90/WPPO5/E5, 80/WPPO10/E10, 70/WPPO15/E15, 60/WPPO20/E20, and 50/WPPO25/E25 reported values of 0.055, 0.0565, 0.06, 0.0615, and 0.0625%.

However, as the speed is increased to 1500 rpm, the values were 0.035, 0.0375, 0.0445, and 0.0475%, respectively. At full engine speed (2000 rpm), all the test fuels showed increased CO concentration with blends 90/WPPO5/E5 and 80/

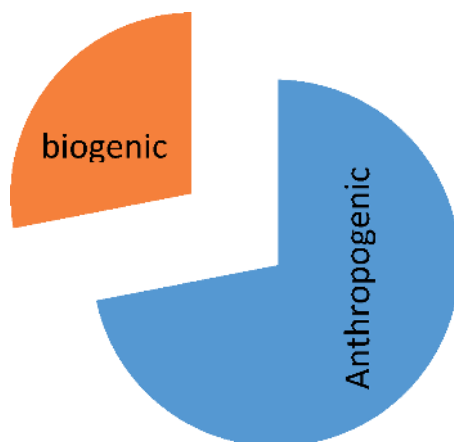

Figure 17. Carbon monoxide (CO) concentrations by anthropogenic and biogenic sources in the United States [77].

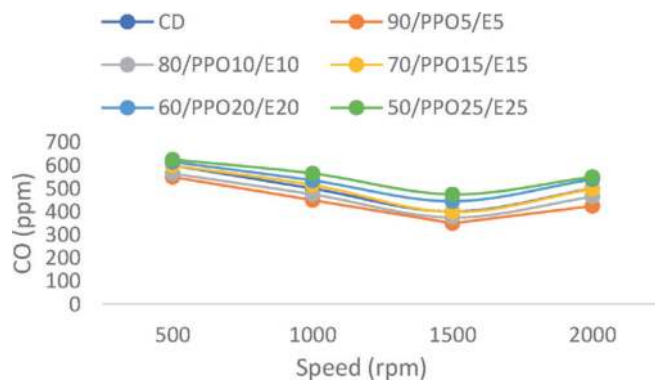

Figure 18.
Carbon monoxide versus engine speed.

WPPO10/E10 reporting the lowest concentration among the test blends across all the engine speed conditions. At 1000 rpm, the blends reported values of 0.0445 and 0.0475% compared to full engine speed (2000 rpm) with 0.0425 and 0.0465%, respectively. The increased CO concentration, although lower than diesel fuel, can be attributed to partial combustion [78] as the speed increased and the presence of ethanol, which shortened ignition delay, thus increasing CO concentration.

As the engine speed and the blend ratio increased, there was an increase in the CO emission across all the engine speeds and within the blends and CD test fuel. At 1000 rpm engine speed, the values of the blends and CD were 0.045, 0.0475, 0.0515, 0.0535, 0.0565, and 0.05% for 90/WPPO5/E5, 80/WPPO10/E10, 70/WPPO15/E15, 60/WPPO20/E20, 50/WPPO25/E25, and CD, respectively. The above values obtained from **Figure 18** suggest that there was a reduction in CO concentration across all test fuels irrespective of blend ratio and type of fuel except at high engine speeds exceeding 1500 rpm to full engine speed (2000 rpm). After this point, there was a steady increase in the concentration of CO.

CO concentration is a direct result of poor oxidation of the hydrocarbon fuels in the combustion chamber but is determined by the local fuel/air equivalence ratio. The above scenario is due to the air/fuel ratio becoming richer as the speed increased, leading to insufficient mixing of oxygen and fuel molecules. Compared to CD, all the biodiesels tested showed decreased CO concentration due to the high oxygen content in the test biodiesels and the addition of EHN, which greatly increased the cetane number (CN). This is identical to the studies by the authors of Refs. [79, 80]. The initial concentrations were greater at the starting engine speed of 500 rpm due to low temperature and emission instability processes at lower engine speeds, which are identical to the studies of Ref. [81]. However, as the engine speed increased from 1500 rpm toward full engine speed (2000 rpm), there was an observed increase in CO concentration, despite the oxygen content of the biodiesel and increased CN of the blends of WPPO, ethanol, and EHN. This disagreement in experimental results is due to differences in CN for the different biodiesel test fuel blends used. The increment in CN as the blend ratio increased led to increases in fuel quantity burnt during diffusive combustion, hence increasing CO concentration as the quality of combustion decreased.

5.5 Particulate matter (PM) formation

PM is agglomerates of small particle phase compounds resulting from the combustion of partially burned lubrication oil, the ash content from the fuel, sulfates from the engine cylinder wall, lubrication oil, and water from condensation and the

combustion process [82]. These emitted compounds comprise elemental carbon (EC), organic carbon (OC) trace, and unknown compounds. Both EC and OC contribute to the toxicity of PM, regional haze, and climate change; therefore, PM concentration negatively affects the environment and human health [83]. The Global Burden of Disease Index reports that these types of emission are now responsible for 3.2 million deaths due to PM_{2.5} ambient pollution [84]. Besides this, PM concentration causes deposit formation in the combustion chamber, fouling of emission control systems such as EGR and DPF and increased engine wear and premature failure.

PM concentration is primarily controlled by factors such as fuel quality (sulfur and ash content in fuel), engine lubrication oil quality, fuel consumption per combustion cycle of the engine, exhaust cooling rate, and the combustion process or strategy applied [85]. A number of PM characterization research works have been conducted categorizing PM concentration as 41% carbon, 7% unburned fuel, 25% unburned oil, 14% sulfates, water, 13% ash, and other concentrations [83]. However, an earlier study conducted by Agrawal et al. [86] reported that particulate concentration contains $\approx 31\%$ elemental carbon, $\approx 14\%$ sulfates and moisture, $\approx 7\%$ unburnt fuel, and $\approx 40\%$ unburnt lubricating oil. A study by Thiruvengadam et al. [87] yielded a similar outcome in terms of PM concentration except that the study was based on natural gas engine technology.

PM concentration is divided into three main components: SOF, soot, and inorganic fraction (IF), 50% of which is released as soot in the diesel exhaust pipe. SOF emissions are made up of condensed hydrocarbons embedded within the soot emissions in the form of very fine particles. The size distribution of PM concentration has three peaks: the nucleation peak, which includes all volatile hydrocarbons ($D_p < \sim 30$ nm), the accumulation mode (~ 30 nm $< D_p < \sim 500$ nm), and the coarse mode (~ 500 nm $< D_p < \sim 10$ μ m) [88]. These emissions are more pronounced during starting and engine idling when engine temperatures are reportedly very low [89].

Studies on OC/EC in PM samples show that their ratio is elevated in biodiesel combustion as the biodiesel blend ratio increases. This is mainly due to the high oxygen content in biodiesel and plays a major role in the generation of soot particles and final oxidation. For example, in a study by Chuepeng et al. [90], the authors reported that the OC fraction for B30 was greater than ULSD regardless of the engine speed and operating conditions. In another study by Williams et al. [91], a similar pattern was established for OC and EC as B100 > B20 > Diesel. This is identical to the studies of Ref. [90], which suggested an increased OC content with increased biodiesel fraction in a blend.

Cheung et al. [92] used soy methyl esters in an LD engine and found that the EC fraction was lower than during diesel operation. Nevertheless, the OC fraction in the PM concentration sample became identical for both LD and HD engines with the New European Driving Cycle (NEDC). However, a study by Song et al. [10] differs with this finding. Using cottonseed biodiesel, the authors reported decreased OC and EC driving conditions. This was mainly due to engine operating conditions, test methods, and test fuel chemical properties [83]. However, these studies have been inconsistent and inconclusive in the literature surveyed. For example, this is revealed in the studies of Refs. [90, 92–96].

DPF filters have now become part of virtually all diesel vehicles in the leading industrialized countries in the world (Europe, the United States, and Japan). DPF filters have had a high market penetration in Japanese and American LD and HD trucks since 2007. For smaller vehicle applications, subsequent developments have incorporated the diesel oxidation catalyst (DOC) function into the filter as reported by the authors of Refs. [10, 97]. It should be noted that for PM emission control in medium engines, the methods and approaches used are similar to the LD engines. However, in the US market, auxiliary fuel injectors and burners are incorporated into the

diesel exhaust to regenerate DPFs. This method has concerns over oil dilution in the crankcase and requires a separation with the engine management system demands, so it has become more complex in the manner of its development and use [98, 99].

Advances in the science of materials have greatly increased and therefore influenced the development in filter materials for LD and HD engines. LD vehicles have seen silicon carbide types of filters becoming standard installation, although the alternative use of aluminum titanate is gradually replacing it [97]. However, aided by better engine controls, the industry has now moved to cordierite filters [101, 102]. **Figure 19** shows new hybrid developments in DPF filtering technology, which reduces 95% of NO_x that comes from the DPF filter.

As shown in **Figure 20**, speed affects particle emission of blends. Nevertheless, differences in engine operating conditions, particulate formation, in-cylinder combustion processes, and engine type give mixed results and conclusions in PM emission studies. In **Figure 20**, it is evident that as speed increases, combustion time (residence time) is reduced, which reduces the reoxidation and combustion of the constituents of the process. This aptly explains the reason behind increased PM particle size and concentration as the speed tends toward full engine speed (2000 rpm), as typified in the graph in **Figure 20**. For example, PM concentration at 500 rpm is 0.15, 0.11, 0.094, 0.086, 0.063, and 0.051 kg/kWh, respectively, for CD, 90/WPPO5/E5, 80/WPPO10/E10, 70/WPPO15/E15, 60/WPPO20/E20, and 50/WPPO25/E25.

However, as the speed increases from 500 to 1500 rpm, which is an intermediate speed, the PM emission increases and almost doubles to 0.29, 0.25, 0.235, 0.213, 0.183, and 0.57 g/kWh. These are for CD, 90/WPPO5/E5, 80/WPPO10/E10, 70/WPPO15/E15, 60/WPPO20/E20, and 50/WPPO25/E25, respectively. These findings are identical to the studies of Refs. [103, 104]. In other words, these blends, when combusting, produce low heat loss to the wall resulting in increased soot oxidation, which is also reported conclusively in a study by Di Iorio et al. [105] and is identical to the findings of this work in **Figure 20**.

Since PM concentrations are influenced by engine operating conditions at 1500–2000 rpm, PM concentration decreases with increased blend fraction. The reduction is more with higher blend ratios 70/WPPO15/E15, 60/WPPO20/E20, and 50/WPPO25/E25 at 2000 rpm. However, there is a reversed reduction in CD fuel compared to the blends of WPPO as shown in **Figure 20**. This is due to diffusive combustion as the blend ratio increases (tends to B100) and the oxygen content of the blends increases. These findings are identical to the findings of a study by Di Iorio et al. [105].

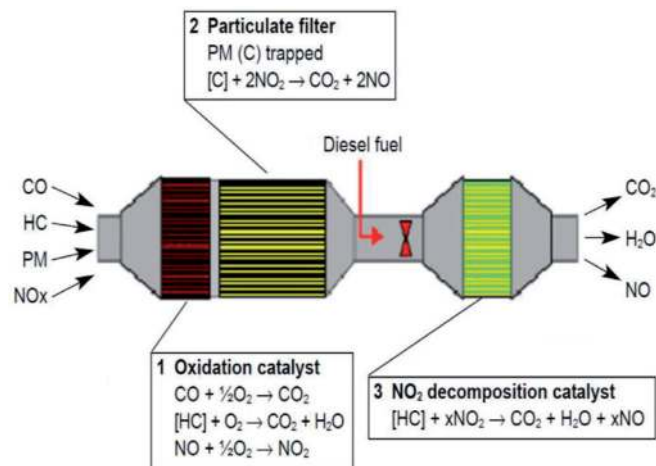

Figure 19. A new NO_2 remediation system reduces 95% of the NO_2 emissions from catalyzed filter systems (courtesy of Technical University Dresden and Johnson Matthey) [100].

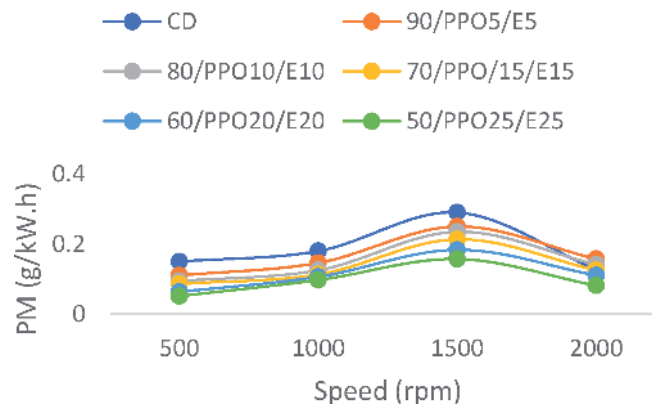

Figure 20.
 PM emission for different blends of WPPO biodiesel fuel from 500 rpm to full engine speed (2000 rpm).

5.6 Carbon dioxide (CO₂) concentration

CO₂ is one of the gases responsible for maintaining the earth's optimal ecosystem balance. It enriches plants through the photosynthesis process and provides other benefits for the environment. However, CO₂ has become a topical global issue in recent decades due to its increase from levels of 0.04% in the atmosphere. The increase in CO₂ causes an increase in global temperatures due to the effect of blanketing. There are generally two sources of CO₂ formation: human activities and naturally occurring sources such as the ocean-atmosphere exchange, plant and animal respiration, soil respiration, decomposition of waste and elements, and volcanic eruptions. The majority of the human sources are due to the burning of hydrocarbon fuels in transport and power generation, land activities such as mining and agriculture, and industrial processes and manufacturing. The main gas produced from human activity is greenhouse gas associated with activities such as combustion of fossil fuels, namely, coal, natural gas, and oil for commercial and transportation services [106].

Figure 21 shows the variation of CO₂ with engine speed. The graph shows that as the blend ratio and engine speed increased, CO₂ concentration increased, but compared to CD, their emission levels were still lower and almost identical. At 500 rpm engine speed, the values of CD and the blends of 90/WPPO5/E5, 80/WPPO10/E10, 70/WPPO15/E15, 60/WPPO20/E20, and 50/WPPO25/E25 were 3.58, 3.35, 2.95, 2.6, 2.55, and 2.25%, respectively.

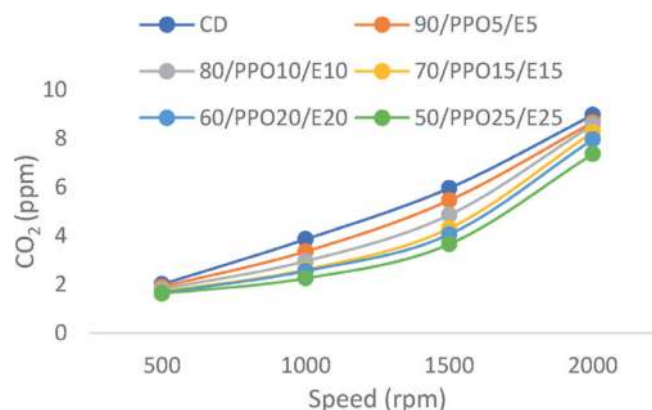

Figure 21.
 CO₂ versus engine speed.

Figure 21 also shows that as the speed increased, there was a significant increase in the CO₂ concentration across all test fuels, although with lower values as the blend ratio increased. For example, CD fuel had values of 2, 3.85, 5.95, and 8.95% for engine speeds of 500, 1000, 1500, and 2000 rpm compared to blend 80/WPPO10/E10 with 1.8, 2.95, 4.85, and 8.55% for similar speeds. The blend with the lowest value of CO₂ emission was 50/WPPO25/E25 with values of 1.62, 2.25, 3.65, and 7.35%, respectively, for engine speeds of 500, 1000, 1500, and 2000 rpm, respectively. The increased carbon concentration in biodiesel blends is due to the reduction in the quantity of carbon relative to the increased oxygen ratio. However, the lower CO₂ concentration levels in comparison to CD fuel are due to factors explained under BTE and the equal energy balance generated by the addition of alcohol.

5.7 Nitrogen oxide (NO_x) concentration

NO_x concentration and its oxidized product NO₂ are the primary preserve of the diesel engine, constituting 85–95% of the total emission of a diesel engine. There are two fundamental differences between the two gases: whereas NO_x is odorless and colorless, NO₂ is reddish with a pungent smell [107]. It should be mentioned here that NO₂ is five times more toxic than NO_x gas and is a health hazard to the human respiratory system. It irritates the respiratory system and lowers the resistance to diseases such as the common cold and influenza [9, 108].

SCR is one of the leading NO_x emission control techniques for both LD and HD vehicles. This system entered the market in Japan and Europe for the HD category in 2005 compared to the US market in 2010. In the Japanese market and in Europe, zeolite and vanadium-based catalysts are utilized, respectively. The zeolite SCR catalyst combination performs better and has higher temperature tolerance levels. There is ongoing research to improve low temperature performance for more accurate NO₂ and NO_x concentration predictions [110–112].

The low NO_x trap (LNT) is a cheaper option for engines that are 2000–2500 cc [113, 114]. This type of emission control technique works better with mixed-mode engines to reduce low-load NO_x that is a persistent problem in SCR systems. This allows the LNT to focus on high temperature NO_x that is entering at temperatures over 300°C, thus eliminating between 60 and 70% of the platinum group metals (PGMs) [115]. This makes the LNT technology cheaper and economically appealing to the LD engine classification of 5000–6000 cc capacity [116, 117]. However, for medium- and heavy-duty vehicles, high temperature solutions have been developed to address the challenge of high load requirements of the US NTE regulatory condition as reported by the authors of Refs. [101, 118].

The LNT technique suffers due to contamination from sulfur, which shortens and affects its service life and durability. Earlier versions of LNT lost 50% filtration capacity, while the current generation of LNTs loses only 25% [119, 120]. Desulfication can be accomplished by passing a rich hot steam of diesel fuel at 700°C for 10 min at service intervals of 5000–10,000 km. **Figure 22** shows a new concept of combining the SCR emission control system with the LNT emission control system.

NO_x concentration is now known to be temperature dependent due to their equilibrium concentration presence in the combustion chamber. NO_x when mixed in high temperature adiabatically in the temperature range of 2000–3000 K forms NO_x concentration, which is then exited through the diesel exhaust system [121]. The NO_x concentration has four basic mechanisms of formation within the combustion chamber of a diesel engine: the Zeldovich mechanism also called the thermal NO_x route, the prompt mechanism, the fuel mechanism, and the NNH mechanism [122]. The variation of engine speed with NO_x concentration is shown in **Figure 23**. The graph shows that as the engine speed was increased, there was an increase in the

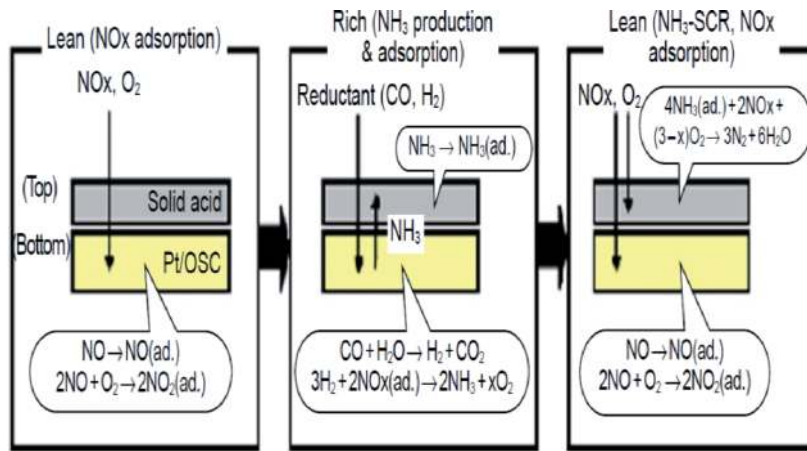

Figure 22.
 The concept of employing a NO_x absorber with a double SCR layer configuration [109].

NO_x concentration irrespective of fuel, blend ratio, or additive. However, the value of NO_x concentration from the blends 90/WPPO5/E5, 80/WPPO10/E10, and 70/WPPO15/E15 reported lower values than CD fuel. For example, at 1000 rpm, the value of the blends was 385, 396, and 415 ppm, compared to CD fuel at 425 ppm.

Blends 60/WPPO20/E20 and 50/WPPO25/E25 had the highest NO_x concentration compared to the other blends of 90/WPPO5/E5, 80/WPPO10/E10, and 70/WPPO15/E15 across all the engine speed conditions tested. At 500 rpm engine speed, the two blends had values of 205 and 200 ppm, respectively. At full engine speed (2000 rpm), NO_x concentration values increased to 925 and 885 ppm compared to blend 90/WPPO5/E5 at 197 ppm and 792 ppm at full engine speed (2000 rpm). The graph in **Figure 23** shows that as the blend ratio increased, there was a direct increase in the concentration of NO_x across all the blended test fuels. However, blend 90/WPPO5/E5 reported the lowest values of NO_x concentration compared to all the other blends. The formation of NO_x in biodiesel combustion depends on the combustion temperatures and combustion zone oxygen concentration. With high blend ratios of 70/WPPO15/E15, 60/WPPO20/E20, and 50/WPPO25/E25, the combustion process is shortened, thus leading to failure to provide enough cooling effect to decrease peak combustion temperatures leading to increased NO_x.

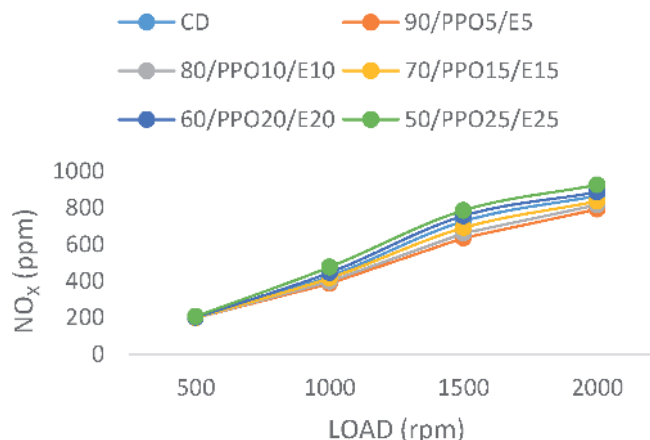

Figure 23.
 Oxides of nitrogen versus engine speed.

These findings seem to show that there is a correlation between the alcohol content in the fuel and peak flame temperatures, content of nitrogen, and oxygen availability [123]. Increased NO_x concentration is attributed to the presence of nitrogen from the cetane number improver ENH and other contaminants from the WPPO composition. Additionally, it could be due to the generation of radicals of hydrocarbon through molecular unsaturation being identical to the findings of Refs. [124, 125]. However, the NO_x levels are still low, attributed to high CNs of the tested biodiesels in **Table 3** and increased oxygen content due to the blend ratios. These findings are identical to the findings of Ref. [126].

6. Conclusion

- This study thus makes a strong case for alternative fuels to replace petroleum-based fossil fuels like diesel commonly used as the primary propulsion fuel in transport and power generation. This work looks at the concept of waste to energy and waste resource utilization in an era when environmental concerns and awareness are at the pick of development agenda across the globe.
- Lower blend ratios 90/WPPO5/E5 and 80/WPPO10/E10 exhibit identical brake-specific fuel consumption (BSFC) of conventional diesel test fuel compared to the other blends. These blends show the lowest BSFC values compared to the others.
- The brake thermal efficiency of blend 90/WPPO5/E5 (90% conventional diesel, waste plastic pyrolysis oil 5%, an ethanol 5% by volume) showed values, which were very close to the values of conventional diesel fuel values. This was attributed to close density values and the gross calorific values of waste plastic pyrolysis oil (WPPO) blends, which showed marginal differences. This case was apparent especially at lower blend ratios of all the mixtures and blends tested.
- There was a reduction in unburnt hydrocarbon (UHC) concentration with the use of WPPO blends, ethanol, and 2-ethyl hexyl nitrate (EHN), with a notable reduction in oxides of nitrogen concentration especially for the blend 90/WPPO5/E (90% conventional diesel, waste plastic pyrolysis oil 5%, and ethanol 5% by volume). This was a clear indication that this blend performed well when compared with petroleum conventional diesel.
- Although there was indicated increase in the concentration of CO , CO_2 , NO_x and UHC, for all the blends of WPPO, ethanol and EHN. There was a clear indication that the emission levels were notably lower than the emission levels of conventional petroleum diesel, based on the ASTM measurements used in this study. However, when comparisons for overall values of concentration are compared to concentration standards, the WPPO blend performed well.
- The blends of WPPO, ethanol, and EHN have identical temperature characteristics to those of the conventional diesel test fuel especially as the engine speeds hit 75% heading to full engine speed. This was attributed to the presence of ethanol responsible for decreased ignition delay. The presence of high oxygen enrichment was a factor of decreased CO concentration for the tested biodiesels compared with conventional diesel fuel, although there was an increase in CO concentration as fuel CN and blend ratio increased. This is due to deterioration of the combustion characteristics, as the cetane numbers (CNs) and the

alcohol blend ratio increase. Nevertheless, this work proposes further study and further investigation on biodiesels with extremely high CN to meet the need for fuel improvers and additives.

Author details

Semakula Maroa^{1*} and Freddie Inambao²

1 College of Agriculture Science and Engineering, University of KwaZulu-Natal, Durban, South Africa

2 Discipline of Mechanical Engineering, Green Energy Group, Durban, South Africa

*Address all correspondence to: ssemakulamaroa@gmail.com

IntechOpen

© 2020 The Author(s). Licensee IntechOpen. This chapter is distributed under the terms of the Creative Commons Attribution License (<http://creativecommons.org/licenses/by/3.0>), which permits unrestricted use, distribution, and reproduction in any medium, provided the original work is properly cited. 

References

- [1] Özgür T, Tosun E, Özgür Tüccar G, Aydin K. Performance, emission and efficiency analysis of a diesel engine operated with diesel and diesel-ethanol (e20) blend. *MATTER: International Journal of Science and Technology*. 2017;3:51-61. DOI: 10.20319/mijst.2017.33.5161
- [2] Geng P, Cao E, Tan Q, Wei L. Effects of alternative fuels on the combustion characteristics and emission products from diesel engines: A review. *Renewable and Sustainable Energy Reviews*. 2017;71:523-534. DOI: 10.1016/j.rser.2016.12.080
- [3] La Rocca HA, A. Shayler P. Towards keeping diesel fuel supply and demand in balance: Dual-fueling of diesel engines with natural gas. *Renewable and Sustainable Energy Reviews*. 2017;70:666-697. DOI: 10.1016/j.rser.2016.11.249
- [4] Asad U, Zheng M. Exhaust gas recirculation for advanced diesel combustion cycles. *Applied Energy*. 2014;123:242-252. DOI: 10.1016/j.apenergy.2014.02.073
- [5] Maroa S, Inambao F. The effects of exhaust gas recirculation on the performance and emission characteristics of a diesel engine—A critical review. *International Journal of Applied Engineering Research*. 2017;12:13677-13689
- [6] Maroa S, Inambao F. Transportation, pollution and the environment. *International Journal of Applied Engineering Research*. 2018;13:3187-3199
- [7] Organization for Economic Co-operation and Development and the International Energy Agency. *CO₂ Emissions from Fuel Combustion 2012*. Organization for Economic Co-operation and Development. 2013. Available from: <http://large.stanford.edu/courses/2013/ph240/rajavi2/docs/co2highlights.pdf> [Accessed: 12 October 2019]
- [8] Olivier JG, Peters JA, Janssens-Maenhout G. *Trends in Global CO₂ Emissions; 2012 Report*. 2012. Available from <http://large.stanford.edu/courses/2013/ph240/rajavi2/docs/co2highlights.pdf> [Accessed: 13 October 2019]
- [9] Reşitoğlu İA, Altinişik K, Keskin A. The pollutant emissions from diesel-engine vehicles and exhaust aftertreatment systems. *Clean Technologies and Environmental Policy*. 2015;17:15-27
- [10] Song X, Johnson JH, Naber JD. A review of the literature of selective catalytic reduction catalysts integrated into diesel particulate filters. *International Journal of Engine Research*. 2015;16:738-749. DOI: 10.1007/s10098-014-0793-9
- [11] Heywood JB. *Internal Combustion Engine Fundamentals*. New York: McGraw-Hill; 2012
- [12] Stone R. *Introduction to Internal Combustion Engines*. London: Palgrave Macmillan; 2012
- [13] Peckham MS, Finch A, Campbell B, Price P, Davies MT. Study of particle number emissions from a turbocharged gasoline direct injection (GDI) engine including data from a fast-response particle size spectrometer. *SAE Technical Paper 0148-7191*. 2011. DOI: 10.4271/2011-01-1224
- [14] World Health Organization. *Global Health Risks: Mortality and Burden of Disease Attributable to Selected Major Risks*. Geneva: World Health Organization; 2009
- [15] Environmental Protection Agency (USA). *Potential Revisions to the*

Nonroad Engine Regulation Citations in the NSPS for Stationary Internal Combustion Engines, June 28, 2017. 2017. Available from: <https://www.epa.gov/stationary-sources-air-pollution/potential-revisions-stationary-internal-combustion-engines-nsps> [Accessed: 25 October 2019]

[16] Waluś KJ, Warguła Ł, Krawiec P, Adamiec JM. Legal regulations of restrictions of air pollution made by non-road mobile machinery—The case study for Europe: A review. *Environmental Science and Pollution Research*. 2018;**25**:3243-3259. DOI: 10.1007/s11356-017-0847-8

[17] Azad A, Rasul M, Khan M, Sharma SC, Bhuiya M. Recent development of biodiesel combustion strategies and modelling for compression ignition engines. *Renewable and Sustainable Energy Reviews*. 2016;**56**:1068-1086. DOI: 10.1016/j.rser.2015.12.024

[18] Agarwal AK, Agarwal RA, Gupta T, Gurjar BR. *Biofuels: Technology, Challenges and Prospects*. Berlin: Springer; 2017

[19] Gan S, Ng HK, Pang KM. Homogeneous charge compression ignition (HCCI) combustion: Implementation and effects on pollutants in direct injection diesel engines. *Applied Energy*. 2011;**88**:559-567. DOI: 10.1016/j.apenergy.2010.09.005

[20] Bendu H, Murugan S. Homogeneous charge compression ignition (HCCI) combustion: Mixture preparation and control strategies in diesel engines. *Renewable and Sustainable Energy Reviews*. 2014;**38**:732-746. DOI: 10.1016/j.energy.2014.05.086

[21] Zhao Y, Wang Y, Li D, Lei X, Liu S. Combustion and emission characteristics of a DME (dimethyl ether)-diesel dual fuel premixed charge compression ignition engine

with EGR (exhaust gas recirculation). *Energy*. 2014;**72**:608-617. DOI: 10.1016/j.energy.2014.05.086

[22] Jain A, Singh AP, Agarwal AK. Effect of fuel injection parameters on combustion stability and emissions of a mineral diesel fueled partially premixed charge compression ignition (PCCI) engine. *Applied Energy*. 2017;**190**:658-669. DOI: 10.1016/j.apenergy.2016.12.164

[23] Qiu L, Cheng X, Liu B, Dong S, Bao Z. Partially premixed combustion based on different injection strategies in a light-duty diesel engine. *Energy*. 2016;**96**:155-165. DOI: 10.1016/j.energy.2015.12.052

[24] Nemati A, Khalilarya S, Jafarmadar S, Khatamnezhad H, Fathi V. Effect of injection characteristics on emissions and combustion of a gasoline fuelled partially-premixed compression ignition engine. *International Journal of Automotive Engineering*. 2011;**1**:29-37

[25] Yang B, Wang H, Yao M, Zheng Z, Liu J, Ma N, et al. Experimental investigation on the effects of injection strategy on combustion and emission in a heavy-duty diesel engine fueled with gasoline. *SAE Technical Paper 0148-7191*. 2017. DOI: 10.4271/2017-01-2266

[26] Yousefi A, Guo H, Birouk M. An experimental and numerical study on diesel injection split of a natural gas/diesel dual-fuel engine at a low engine speed. *Fuel*. 2018;**212**:332-346. DOI: 10.1016/j.fuel.2017.10.053

[27] Saraei SH, Khalilarya S, Jafarmadar S. Numerically modeling of diesel engine and analysis the effects of double injection strategies on performance and pollutant emissions. *International Journal of Automotive Engineering*. 2016;**6**:2182-2192

[28] Liu H, Ma G, Hu B, Zheng Z, Yao M. Effects of port injection of hydrous

- ethanol on combustion and emission characteristics in dual-fuel reactivity-controlled compression ignition (RCCI) mode. *Energy*. 2017;**145**:592-602. DOI: 10.1016/j.energy.2017.12.089
- [29] Zhiqiang Z, Fuquan Z, Jun D, Liguang L, Yuan S. Simulation and optimization of low temperature combustion in diesel engine at high load. *Automotive Engineering*. 2012;**34**:763-770
- [30] Shi L, Xiao W, Li M, Lou L, Deng K-Y. Research on the effects of injection strategy on LTC combustion based on two-stage fuel injection. *Energy*. 2017;**121**:21-31. DOI: 10.1016/j.energy.2016.12.128
- [31] Ramadhans AS, Xu Liu HD, Tian J. Reducing cold start emissions from automotive diesel engine at cold ambient temperatures. *Aerosol and Air Quality Research*. 2016;**16**:3330-3337. DOI: 10.4209/aaqr.2015.11.0616
- [32] Weiss M, Bonnel P, Kühlwein J, Provenza A, Lambrecht U, Alessandrini S, et al. Will Euro 6 reduce the NO_x emissions of new diesel cars?—Insights from on-road tests with portable emissions measurement systems (PEMS). *Atmospheric Environment*. 2012;**62**:657-665. DOI: 10.1016/j.atmosenv.2012.08.056
- [33] Johnson BT. Diesel engine emissions and their control. *Platinum Metals Review*. 2008;**52**:23-37. DOI: 10.1595/147106708x248750
- [34] Stanton DW, Lippert AM, Reitz RD, Rutland C. Influence of spray-wall interaction and fuel films on cold starting in direct injection diesel engines. SAE Technical Paper 0148-7191. 1998. DOI: 10.4271/982584
- [35] Park Y, Hwang J, Bae C, Kim K, Lee J, Pyo S. Effects of diesel fuel temperature on fuel flow and spray characteristics. *Fuel*. 2015;**162**:1-7. DOI: 10.1016/j.fuel.2015.09.008
- [36] Tian J, Xu H, Sakunthalai RA, Liu D, Tan C, Ghafourian A. Low ambient temperature effects on a modern turbocharged diesel engine running in a driving cycle. *SAE International Journal of Fuels and Lubricants*. 2014;**7**:726-736. DOI: 10.4271/2014-01-2713
- [37] Starck L, Faraj A, Perrin H, Forti L, Jeuland N, Walter B. Cold start on diesel engines: Effect of fuel characteristics. *SAE International Journal of Fuels and Lubricants*. 2010;**3**:165-174. DOI: 10.4271/2010-01-1506
- [38] Liu D, Xu H, Tian J, Tan C, Li Y. Cold and warm start characteristics using HVO and RME blends in a V6 diesel engine. *SAE International Journal of Fuels and Lubricants*. 2013;**6**:478-485. DOI: 10.4271/2013-01-1306
- [39] Brown N, Gupta V, Rocca AL, Shayler P, Murphy M, Pegg I, et al. Investigations of fuel injection strategy for cold starting direct-injection diesel engines. *Proceedings of the Institution of Mechanical Engineers, Part D: Journal of Automobile Engineering*. 2007;**221**:1415-1424. DOI: 10.1243/09544070JAUTO473
- [40] Thom R. Emission-Immission Regularien Eine Aundauernde Herausforderung. In: 3rd Conference on Emission Control, Dresden, Germany. May 2006
- [41] Steinparzen F. Dieselmotoren für PKW: Gestern-Heute-Morgen. In: 18th AVL Conference, Engine and Environment, Helmut-List-Halle Conference Centre, Graz, Austria, 7-8 September, 2006
- [42] Cooper B, Penny I, Beasley M, Greaney A, Crump J. Advanced diesel technology to achieve tier 2 bin 5 emissions compliance in US light-duty diesel applications; SAE Technical Paper 0148-7191. 2006. DOI: 10.4271/2006-01-1145

- [43] Park S-K, Lee J, Kim H-M. Experimental study on the spiral and oval spiral EGR cooler efficiencies in a diesel engine. *Heat and Mass Transfer*. 2014;**50**:1783-1789. DOI: 10.1007/s00231-014-1362-9
- [44] Adomeit P, Pischinger S, Becker M, Rohs H, Greis A. Laser optical diagnostics and numerical analysis of HSDI combustion systems. In: *Proceedings of Conference on Thermo- and Fluid Dynamic Processes in Diesel Engines 2*. Thiesel. Valencia, Spain; 11-13 September 2002. p. 331
- [45] Pickett L. Soot formation at low flame temperature diesel operating conditions. In: *9th International Conference, Present and Future Engines for Automobiles*. San Antonio, TX, USA: SAE Transactions; 2005
- [46] Nova I, Tronconi E. Urea-SCR Technology for deNO_x after Treatment of Diesel Exhausts. Berlin: Springer; 2014
- [47] Twigg MV. Urea-SCR technology for deNO_x after treatment of diesel exhausts. Book review. *Johnson Matthey Technology Review*. 2015;**59**:221-232
- [48] Walker A. Future challenges and incoming solutions in emission control for heavy-duty diesel vehicles. *Topics in Catalysis*. 2016;**59**:695-707. DOI: 10.1007/s11244-016-0540-z
- [49] Thangaraja J, Kannan C. Effect of exhaust gas recirculation on advanced diesel combustion and alternate fuels—A review. *Applied Energy*. 2016;**180**:169-184. DOI: 10.1016/j.apenergy.2016.07.096
- [50] Divekar PS, Chen X, Tjong J, Zheng M. Energy efficiency impact of EGR on organizing clean combustion in diesel engines. *Energy Conversion and Management*. 2016;**112**:369-381. DOI: 10.1016/j.enconman.2016.01.042
- [51] Schnitzler J. Particulate Matter and NO_x Exhaust after Treatment Systems. Aachen, Germany: FEV Metroethnic GmbH; 2006
- [52] Ward C. Diesel exhaust after-treatment maintenance. *Tech Directions*. 2017;**76**:26
- [53] Yun BK, Kim MY. Modeling the selective catalytic reduction of NO_x by ammonia over a Vanadia-based catalyst from heavy duty diesel exhaust gases. *Applied Thermal Engineering*. 2013;**50**:152-158. DOI: 10.1016/j.applthermaleng.2012.05.039
- [54] Azama A, Alia S, Iqbala A. Emissions from diesel engine and exhaust after treatment technologies. In: *4th International Conference on Energy, Environment and Sustainable Development 2016 (EESD 2016)*; 2016
- [55] Turns SR. *An Introduction to Combustion*. Vol. 499. New York: McGraw-Hill; 1996
- [56] Zhang Y, Lou D, Tan P, Hu Z, Feng Q. Experimental study on particulate emission characteristics of an urban bus equipped with CCRT after-treatment system fuelled with biodiesel blend. *SAE Technical Paper 0148-7191*. 2017. DOI: 10.4271/2017-01-0933
- [57] Guardiola C, Pla B, Piqueras P, Mora J, Lefebvre D. Model-based passive and active diagnostics strategies for diesel oxidation catalysts. *Applied Thermal Engineering*. 2017;**110**:962-971. DOI: 10.1016/j.applthermaleng.2016.08.207
- [58] Chen K-S, Lin Y-C, Hsu K-H, Wang H-K. Improving biodiesel yields from waste cooking oil by using sodium methoxide and a microwave heating system. *Energy*. 2012;**38**:151-156. DOI: 10.1016/j.energy.2011.12.020
- [59] American Petroleum Institute. HPV Testing Group Kerosene/ Jet Fuel Category Assessment

Document. Submitted to the US EPA by the American Petroleum Institute, Consortium Registration 1100997; 2010

[60] Harley RA, Kean AJ. Chemical Composition of Vehicle-Related Volatile Organic Compound Emission in Central California. USA: Department of Civil and Environmental Engineering, University of California; 2004

[61] Ghosh P, Hickey KJ, Jaffe SB. Development of a detailed gasoline composition-based octane model. Industrial and Engineering Chemistry Research. 2006;**45**:337-345. DOI: 10.1021/ie050811h

[62] Lapuerta M, Armas O, Hernández JJ, Tsolakis A. Potential for reducing emissions in a diesel engine by fuelling with conventional biodiesel and Fischer-Tropsch diesel. Fuel. 2010;**89**:3106-3113. DOI: 10.1016/j.fuel.2010.05.013

[63] Bhaskar K, Nagarajan G, Sampath S. The performance and emission characteristics of fish oil methyl esters (fome) and diesel blends in a partially premixed charge compression ignition engine. International Journal of Green Energy. 2014;**11**:389-403. DOI: 10.1080/15435075.2013.773514

[64] Venkatesan H, Sivamani S, Bhutoria K, Vora HH. Assessment of waste plastic oil blends on performance, combustion and emission parameters in direct injection compression ignition engine. International Journal of Ambient Energy. 2017;**40**:1-9. DOI: 10.1080/01430750.2017.1381155

[65] Kaimal VK, Vijayabalan P. An investigation on the effects of using DEE additive in a DI diesel engine fuelled with waste plastic oil. Fuel. 2016;**180**:90-96. DOI: 10.1016/j.fuel.2016.04.030

[66] Karjalainen P, Ntziachristos L, Murtonen T, Wihersaari H, Simonen P,

Mylläri F, et al. Heavy-duty diesel exhaust particles during engine motoring formed by lube oil consumption. Environmental Science & Technology. 2016;**50**:12504-12511. DOI: 10.1021/acs.est.6b03284

[67] Lee D, Choi S, Lee C. Impact of SME blended fuel combustion on soot morphological characteristics in a diesel engine. International Journal of Automotive Technology. 2013;**14**:757-762. DOI: 10.1007/s12239-013-0083-2

[68] Ghobadian B, Rahimi H, Nikbakht A, Najafi G, Yusaf T. Diesel engine performance and exhaust emission analysis using waste cooking biodiesel fuel with an artificial neural network. Renewable Energy. 2009;**34**:976-982. DOI: 10.1016/j.renene.2008.08.008

[69] Ganesh D, Gowrishankar G. Effect of nano-fuel additive on emission reduction in a biodiesel fuelled CI engine. International Conference on Electrical and Control Engineering. 2011;**2011**:3453-3459. DOI: 10.1109/ICECENG.2011.6058240

[70] Babu P, Rao K, Rao B, Srivastava S, Beohar H, Gupta B. The role of oxygenated fuel additive (DEE) along with Mahuva methyl ester to estimate performance and emission analysis of DI-diesel engine. International Journal of Thermal Technologies. 2012;**2**:119-123

[71] Fattah IR, Masjuki H, Kalam M, Wakil M, Ashraf A, Shahir SA. Experimental investigation of performance and regulated emissions of a diesel engine with *Calophyllum inophyllum* biodiesel blends accompanied by oxidation inhibitors. Energy Conversion and Management. 2014;**83**:232-240. DOI: 10.1016/j.enconman.2014.03.069

[72] Kalam M, Masjuki H. Testing palm biodiesel and NPAA additives to

- control NO_x and CO while improving efficiency in diesel engines. *Biomass and Bioenergy*. 2008;**32**:1116-1122. DOI: 10.1016/j.biombioe.2008.02.009
- [73] Tutak W, Lukács K, Szwaja S, Bereczky Á. Alcohol-diesel fuel combustion in the compression ignition engine. *Fuel*. 2015;**154**:196-206. DOI: 10.1016/j.fuel.2015.03.071
- [74] Lujaji F, Kristóf L, Bereczky A, Mbarawa M. Experimental investigation of fuel properties, engine performance, combustion and emissions of blends containing croton oil, butanol, and diesel on a CI engine. *Fuel*. 2011;**90**: 505-510. DOI: 10.1016/j.fuel.2010.10.004
- [75] Sanli H, Canakci M, Alptekin E, Turkcan A, Ozsezen A. Effects of waste frying oil-based methyl and ethyl ester biodiesel fuels on the performance, combustion and emission characteristics of a DI diesel engine. *Fuel*. 2015;**159**:179-187. DOI: 10.1016/j.fuel.2015.06.081
- [76] Shirneshan A. HC, CO, CO₂ and NO_x emission evaluation of a diesel engine fueled with waste frying oil methyl ester. *Procedia—Social and Behavioral Sciences*. 2013;**75**:292-297. DOI: 10.1016/j.sbspro.2013.04.033
- [77] Environmental Protection Agency. *Inventory of US Greenhouse Gas Emissions and Sinks: 1990-2009*. Washington, D.C., United States: Environmental Protection Agency; 2012
- [78] Rahman MM, Hassan MH, Kalam MA, Atabani AE, Memon LA, Rahman SA. Performance and emission analysis of *Jatropha curcas* and *Moringa oleifera* methyl ester fuel blends in a multi-cylinder diesel engine. *Journal of Cleaner Production*. 2014;**65**:304-310. DOI: 10.1016/j.jclepro.2013.08.034
- [79] İçiğür Y, Altıparmak D. Effect of fuel cetane number and injection pressure on a DI diesel engine performance and emissions. *Energy Conversion and Management*. 2003;**44**:389-397. DOI: 10.1016/S0196-8904(02)00063-8
- [80] Wu F, Wang J, Chen W, Shuai S. A study on emission performance of a diesel engine fueled with five typical methyl ester biodiesels. *Atmospheric Environment*. 2009;**43**:1481-1485. DOI: 10.1016/j.atmosenv.2008.12.007
- [81] Patil A, Taji S, Relekar MAN, Patil MAN, Dhananjay M, Khamkar M, et al. Investigation on effect of oxygenated additive on multicylinder diesel engine performance and emission. *International Journal of Innovative Research in Science, Engineering and Technology*. 2014;**3**:14113-14120
- [82] Lin SL, Lee WJ, Lee CF, Chen SJ. Energy savings and emission reduction of nitrogen oxides, particulate matter, and polycyclic aromatic hydrocarbons by adding water-containing acetone and neat soybean oil to a diesel-fueled engine generator. *Energy & Fuels*. 2010;**24**:4522-4533. DOI: 10.1021/ef100556b
- [83] Wang Y, Liu H, Lee C-FF. Particulate matter emission characteristics of diesel engines with biodiesel or biodiesel blending: A review. *Renewable and Sustainable Energy Reviews*. 2016;**64**:569-581. DOI: 10.1016/j.rser.2016.06.062
- [84] Apte JS, Marshall JD, Cohen AJ, Brauer M. Addressing global mortality from ambient PM_{2.5}. *Environmental Science & Technology*. 2015;**49**:8057-8066. DOI: 10.1021/acs.est.5b01236
- [85] Barrios CC, Domínguez-Sáez A, Martín C, Álvarez P. Effects of animal fat-based biodiesel on a TDI diesel engine performance, combustion characteristics and particle number and size distribution emissions. *Fuel*.

2014;**117**:618-623. DOI: 10.1016/j.fuel.2013.09.037

[86] Agrawal AK, Singh SK, Sinha S, Shukla MK. Effect of EGR on the exhaust gas temperature and exhaust opacity in compression ignition engines. *Sadhana*. 2004;**29**:275-284. DOI: 10.1007/BF02703777

[87] Thiruvengadam A, Besch MC, Yoon S, Collins J, Kappanna H, Carder DK, et al. Characterization of particulate matter emissions from a current technology natural gas engine. *Environmental Science & Technology*. 2014;**48**:8235-8242. DOI: 10.1021/es5005973

[88] Kittelson D, Kraft M. Particle formation and models. In: *Encyclopedia of Automotive Engineering*. Hoboken: Wiley Publishing Company; Available from: <https://doi.org/10.1002/9781118354179.auto161>

[89] Tighe C, Twigg M, Hayhurst A, Dennis J. The kinetics of oxidation of diesel soots by NO₂. *Combustion and Flame*. 2012;**159**:77-90. DOI: 10.1021/es903672y

[90] Chuepeng S, Xu H, Tsolakis A, Wyszynski M, Price P, Stone R, et al. Particulate emissions from a common rail fuel injection diesel engine with RME-based biodiesel blended fuelling using thermo-gravimetric analysis. *SAE Technical Paper 0148-7191*. 2008. DOI: 10.4271/2008-01-0074

[91] Williams A, McCormick RL, Hayes RR, Ireland J, Fang HL. Effect of biodiesel blends on diesel particulate filter performance. *SAE Technical Paper 0148-7191*. 2006

[92] Cheung KL, Polidori A, Ntziachristos L, Tzamkiozis T, Samaras Z, Cassee FR, et al. Chemical characteristics and oxidative potential of particulate matter emissions from gasoline, diesel, and biodiesel cars. *Environmental Science & Technology*.

2009;**4**:6334-6340. DOI: 10.1021/es900819t

[93] Agarwal AK, Gupta T, Shukla PC, Dhar A. Particulate emissions from biodiesel fuelled CI engines. *Energy Conversion and Management*. 2015;**94**:311-330. DOI: 10.1016/j.enconman.2014.12.094

[94] Oprescu E-E, Dragomir RE, Radu E, Radu A, Velea S, Bolocan I, et al. Performance and emission characteristics of diesel engine powered with diesel-glycerol derivatives blends. *Fuel Processing Technology*. 2014;**126**:460-468. DOI: 10.1016/j.fuproc.2014.05.027

[95] Ashraful A, Masjuki H, Kalam M. Particulate matter, carbon emissions and elemental compositions from a diesel engine exhaust fuelled with diesel-biodiesel blends. *Atmospheric Environment*. 2015;**120**:463-474. DOI: 10.1016/j.atmosenv.2015.09.028

[96] Cheng M-T, Chen H-J, Young L-H, Yang H-H, Tsai YI, Wang L-C, et al. Carbonaceous composition changes of heavy-duty diesel engine particles in relation to biodiesels, after-treatments and engine speeds. *Journal of Hazardous Materials*. 2015;**297**:234-240. DOI: 10.1016/j.jhazmat.2015.04.076

[97] Dorenkamp R. Application of a New Filter Material in Volkswagen's Diesel Particulate Filter System. In: *3rd Conference on Emission Control*, Dresden, Germany; May 2006

[98] Boretto G, Imarisio R, Rellecati P, Barucchi E, Sanguedolce A. Serial Application of a Catalyzed Particulate Filter on Common Rail DI Diesel Engines for Passenger Cars. Barcelona, Spain: F2004V068, FISITA World Automotive Congress; 2004. pp. 23-27

[99] Rothe D, Knauer M, Emmerling G, Deyerling D, Niessner R. Emissions during active regeneration of a diesel particulate filter on a heavy-duty diesel

- engine: Stationary tests. *Journal of Aerosol Science*. 2015;**90**:14-25. DOI: 10.1016/j.jaerosci.2015.07.007
- [100] Goersmann C. PM control systems with low NO₂ emissions. In: 3rd Conference on Emission Control, Dresden, Germany; May 2006
- [101] Zink UH, Johnson TV. State-of-the-art filter regeneration management—Concepts realized by LDV companies. In: U.S. Dept. of Energy Diesel Engine Emissions Reduction (DEER) Conference; 21-25 August 2005; Chicago, IL, U.S.A. 2005
- [102] Lenz HP. 38th international—Vienna motor symposium. *Sonderprojekte ATZ/MTZ*. 2017;**22**:34-61
- [103] Agarwal A, Gupta KT, Kothari A. Particulate emissions from biodiesel vs diesel fuelled compression ignition engine. *Renewable and Sustainable Energy Reviews*. 2011;**15**:3278-3300. DOI: 10.1016/j.rser.2011.04.002
- [104] Zhu L, Cheung C, Huang Z. A comparison of particulate emission for rapeseed oil methyl ester, palm oil methyl ester and soybean oil methyl ester in perspective of their fatty ester composition. *Applied Thermal Engineering*. 2016;**94**:249-255. DOI: 10.1016/j.applthermaleng.2015.10.132
- [105] Di Iorio S, Magno A, Mancaruso E, Vaglieco B, Arnone L, Dal Bello L. Engine performance and emissions of a small diesel engine fueled with various diesel/RME blends. *SAE Paper*: 32-0135. 2014. DOI: 10.4271/2014-32-0135
- [106] Turns SR. *An Introduction to Combustion*. Vol. 287. New Delhi: McGraw-hill Education India; 2012
- [107] Hoekman SK, Robbins C. Review of the effects of biodiesel on NO_x emissions. *Fuel Processing Technology*. 2012;**96**:237-249. DOI: 10.1016/j.fuproc.2011.12.036
- [108] Kim K-H, Kabir E, Kabir S. A review on the human health impact of airborne particulate matter. *Environment International*. 2015;**74**:136-143. DOI: 10.1016/j.envint.2014.10.005
- [109] Nakatsuji T, Matsubara M, Rouistenmäki J, Sato N, Ohno H. A NO_x reduction system using ammonia-storage selective catalytic reduction in rich/lean excursions. *Applied Catalysis B: Environmental*. 2007;**77**:190-201. DOI: 10.1016/j.apcatb.2007.07.018
- [110] Marchitti F, Nova Hemings EB, Forzatti IP, Tronconi E. Enhancing the low-T NH₃-SCR activity of a commercial Fe-zeolite catalyst by NH₄NO₃ dosing: An experimental and modeling study. *Emission Control Science and Technology*. 2016;**2**:1-9. DOI: 10.1007/s40825-015-0030-y
- [111] Myer AM, Holl SM, Tendolkar O, Crofts JD, Johnson S, Khot AD. Ammonia generation system for an SCR system. *Google Patents*; 2016
- [112] Kowatari T, Hamada Y, Amou K, Hamada I, Funabashi H, Takakura T. et al. A study of a new aftertreatment system (1): A new dosing device for enhancing low temperature performance of urea-SCR. *SAE Technical Paper* 0148-7191. 2006
- [113] Johnson TV. Review of diesel emissions and control. *SAE International Journal of Fuels and Lubricants*. 2010;**3**:16-29. DOI: 10.1243/14680874JER04009
- [114] Johnson TV. Review of vehicular emissions trends. *SAE International Journal of Engines*. 2015;**8**:1152-1167. DOI: 10.4271/2015-01-0993
- [115] Theis JR, Ura JA, Goralski CT, Caine J, Davies M, Kay D, et al. The effects of aging temperature and PGM loading on the NO_x storage capacity of a lean NO_x trap. *SAE*

- Technical Paper 0148-7191. 2005. DOI: 10.4271/2005-01-1117
- [116] Leet JA, Simescu S, Froelund K, Dodge LG, Roberts CE. Emissions solutions for 2007 and 2010 heavy-duty diesel engines. SAE Technical Paper 0148-7191. 2004. DOI: 10.4271/2004-01-0124
- [117] Chilumukuru K, Gupta A, Ruth M, Cunningham M, Kothandaraman G, Cumaranatunge L, et al. Aftertreatment architecture and control methodologies for future light duty diesel emission regulations. SAE International Journal of Engines. 2017;**10**:1580-1587. DOI: 10.4271/2017-01-0911
- [118] Guan B, Zhan R, Lin H, Huang Z. Review of state-of-the-art technologies of selective catalytic reduction of NO_x from diesel engine exhaust. Applied Thermal Engineering. 2014;**66**:395-414. DOI: 10.1016/j.applthermaleng.2014.02.021
- [119] Wittka T, Holderbaum B, Dittmann P, Pischinger S. Experimental investigation of combined LNT+ SCR diesel exhaust aftertreatment. Emission Control Science and Technology. 2015;**1**:167-182. DOI: 10.1007/s40825-015-0012-0
- [120] Ming-Cheng W, Han T, Fisher GB. Experimental evaluation of reformate-assisted diesel NO_x trap desulfation. SAE Technical Paper 0148-7191. 2005. DOI: 10.4271/2005-01-3878
- [121] Rao KS. Effect of EGR on diesel engine performance and exhaust emission running with cotton seed biodiesel. International Journal of Mechanical and Mechatronic Engineering. 2016;**16**:64-69
- [122] Bowman CT. Control of combustion-generated nitrogen oxide emissions: Technology driven by regulation. In Symposium (International) on Combustion. 1992:859-878
- [123] Heywood JB. Internal Combustion Engine Fundamentals Vol. 930. New York: McGraw-Hill; 1988
- [124] Benjumea P, Agudelo JR, Agudelo AF. Effect of the degree of unsaturation of biodiesel fuels on engine performance, combustion characteristics, and emissions. Energy & Fuels. 2010;**25**:77-85. DOI: 10.1021/ef101096x
- [125] Altun Ş. Effect of the degree of unsaturation of biodiesel fuels on the exhaust emissions of a diesel power generator. Fuel. 2014;**11**:450-457. DOI: 10.1016/j.fuel.2013.09.028
- [126] Zhu Z, Guo H, Zhou A, Li D, Liu S. One way to reduce the NO_x emission of biodiesels: The increase of cetane number. International Journal of Green Energy. 2016;**13**:957-962. DOI: 10.1080/15435075.2011.647366