

---

# Application of Some Natural Porous Raw Materials for Removal of Lead and Zinc from Aqueous Solutions

---

Mirjana Golomeova and Afrodita Zendelska

Additional information is available at the end of the chapter

<http://dx.doi.org/10.5772/62347>

---

## Abstract

This chapter discusses the adsorption of lead and zinc ions onto a natural zeolite (clinoptilolite) and zeolite bearing tuff (stilbite) from aqueous solution, whereby the main parameters were the effects of initial pH of solution, mass of adsorbent, and initial metal concentration in solution.

The physical and chemical properties of the natural materials used are characterized by X-ray diffraction, scanning electron microscopy, energy-dispersive spectroscopy, and AES-ICP.

Determination of the maximum capacity of adsorbents for lead and zinc removal under the studied conditions is the main objective of the equilibrium studies. Experimental data are fitted to the Freundlich and Langmuir adsorption models.

The adsorption of lead and zinc ions from diluted solution onto natural zeolite and zeolite bearing tuff occurs efficiently. Determination of the impact of the studied parameters on the efficiency of removal of lead and zinc ions from the solution showed that in the studied range, in the case of lead ions, there were not any significant changes found, but in the case of zinc ions, removal was most effective at lower concentration of zinc ions, higher mass of adsorbents, and higher pH value of the solution.

**Keywords:** natural zeolite—clinoptilolite, zeolite bearing tuff—stilbite, lead, zinc, adsorption

---

## 1. Introduction

Water gets polluted from a number of different sources, and pollutants are divided into various classes, such as organic pollutants, inorganic fertilizers, metals, and radioactive isotopes.

---

Organic pollutants are susceptible to biological degradation, unlike heavy metals which are not degraded into harmless products [1].

Heavy metals may pose an environmental problem, especially if they migrate into surface water or groundwater. Heavy metals are common pollutants found in various industrial effluents. They are often encountered in metal-plating facilities, electroplating, mining operations, acid mine drainage, fertilizers, battery manufacture, dyestuff, chemical, pharmaceutical, electronic device manufactures, and many others.

Because heavy metals are highly toxic and are nonbiodegradable, they must be removed from the polluted streams in order to meet increasingly stringent environmental quality standards. Their removal can be accomplished by various techniques. Conventional methods typically involve such processes as coagulation, precipitation, ion-exchange, electrochemical methods, membrane processes, extraction, adsorption, etc. Among these, adsorption is currently considered to be more suitable for wastewater treatment, with its high efficiency in heavy metal removal, because of its simplicity and cost-effectiveness. Some widely used adsorbents for adsorption of heavy metals include activated carbon [2], clay minerals [3], biomaterials [4], industrial solid wastes, and zeolites [5–11], characterized by a porous structure. Pore sizes of the materials are defined as follows: macropores,  $>50$  nm; mesopores, 2–50 nm; and micropores,  $<2$  nm.

The adsorption process takes place in three steps: macrotransport, microtransport, and sorption. Macrotransport involves the movement of adsorbate through water to the liquid/solid interface by advection and diffusion. Microtransport involves the diffusion through the macropore system of the solid adsorbent, to the adsorption sites in the micropores and the solid adsorbent. Although adsorption also occurs on the surface of the solid adsorbent and in the macropores and micropores, the surface area of these parts of most solid adsorbents is so small compared with the surface area of the micropores that the amount of material adsorbed there is usually considered negligible.

The respective and widely used adsorbent material in the adsorption processes is zeolite, because it has a high adsorption capacity, surface area, and microporous structure.

### 1.1. Zeolites

Zeolites are crystalline microporous minerals which are broadly distributed in nature. During the millions of years, the layers of volcanic ash underwent some physical and chemical changes on exposure to high temperatures and pressures, which resulted in the formation of a diverse group of zeolites.

Zeolites have been known for almost 250 years. It was the Swedish mineralogist Axel Fredrick Cronsted, who in 1756, had the privilege to discover the so-called stilbite. He observed that a large amount of steam was obtained upon heating this material. Therefore, this material was named “zeolite,” which stems from classical Greek, where ζεω (zeo) means “to boil” and λιθος (lithos) means “stone” [12].

Zeolites are crystalline aluminosilicates with open 3D framework structures built of  $\text{SiO}_4$  and  $\text{AlO}_4$  tetrahedra linked to each other by sharing all the oxygen atoms to form regular intracrystalline cavities and channels of molecular dimensions. Zeolite frameworks are made up of four coordinated atoms forming tetrahedra, which are linked by their corners. This feature makes a rich variety of beautiful structures of zeolite. The framework structure of zeolite contains channels, cages, and cavities. These are linked and big enough to allow easy drift of the resident ions and molecules into and out of the structure. Zeolite's low specific density is the result of the system of large voids, which are interconnected and form long wide channels of various sizes depending on the compound [13]. This ability puts zeolites in the class of materials known as "molecular sieves."

A description of zeolite structure usually begins with a description of the framework type in terms of the size of the pore openings and the dimensionality of the channel system. Pore opening is characterized by the size of the ring that defines the pore, designated an  $n$ -ring, where  $n$  is the number of T-atoms in the ring, and T is any tetrahedrally coordinated cation (aluminum or silicon atom). An 8-ring is considered to be a small pore opening, a 10-ring a medium one, and a 12-ring a large one, with free diameter (calculated using an oxygen radius of 1.35 Å) of approximately 4.1, 5.5 and 7.4 Å, respectively. Of course, rings can be distorted considerably; so, these numbers should only be used as a rough guide [14]. For zeolites containing larger rings, ions and molecules can enter the intracrystalline space. For rings that contain 6 T atoms (six-membered rings or 6-ring) or less, the size of the window is ~2 Å, and movement of species through these rings is restricted. Ions or molecules can be trapped in cages bound by rings of this size or smaller (5-, 4-, or 3-ring) [15].

The internal volume of zeolites consists of interconnected cages or channels, which can have dimensionalities of one or three. Pore sizes can vary from 0.2 to 0.8 nm, and pore volumes from 0.10 to 0.35  $\text{cm}^3/\text{g}$  [15].

Another unique property of zeolites is that they are one of the few "negatively charged" minerals found in nature. The aluminosilicate framework is negatively charged and attracts the positive cations that reside in cages, such as sodium ( $\text{Na}^+$ ), potassium ( $\text{K}^+$ ), calcium ( $\text{Ca}^{+2}$ ), and magnesium ( $\text{Mg}^{+2}$ ), to compensate the negative charge of the framework. Unlike most other tectosilicates, zeolites have larger cages in their structure [13].

Zeolites are also characterized by the unique property that the internal surface is highly accessible and can compose more than 98% of the total surface area. Surface area is typically of the order of 300–700  $\text{m}^2/\text{g}$  [15].

Thermal stability of zeolites varies over a large temperature range. The decomposition temperature for low-silica zeolites (Si/Al ratio  $\approx 1$ ) is  $\sim 700^\circ\text{C}$ , whereas completely siliceous zeolite, such as silicalite, is stable up to  $1300^\circ\text{C}$ . Low-silica zeolites are unstable in acid, whereas high-silica zeolites (Si/Al ratio  $\geq 10$ ) are stable in boiling mineral acids, though unstable in basic solutions. Low-silica zeolites tend to have structures with 4, 6, and 8 rings, whereas more siliceous zeolites contain 5-ring structure. Low-silica zeolites are hydrophilic, whereas high-silica zeolites are hydrophobic [15].



Figure 1. Structure of zeolite.

The properties of the porous materials depend both on the chemistry of the framework and the pore structures (**Figure 1**). The growing need for materials with highly specific physical and chemical properties as zeolites has inspired scientists to make new materials with high porosity and unique structures. Many of the zeolites occur naturally as minerals, but most of them have been made synthetically; some of them have been made for commercial use, while others have been created by scientists to study their chemistry. At present, there are 191 unique zeolite frameworks identified [16], and over 40 naturally occurring mineral frameworks are recognized members of the zeolite group. These are the members of the zeolite group: Analcime Family, Chabazite Family, Gismondine Family, Harmotome Family, Heulandite Family, Natrolite Family, and Stilbite Family.

Zeolites are quite complex structures; hence, their classification requires several attempts. However, the old classification of zeolites does not lose its importance, and forms the basis of morphological significance of zeolites. All zeolites can be classified into three groups: fibrous zeolites, platy or lamellar zeolites, and cubic or robust zeolites. This classification was later expanded in order to include other natural zeolites. Instead of physical properties, classification was based on the presence of a complex structural unit of tetrahedron that was considered to constitute a fundamental unit characteristic of each group or family. Some minor variations in these units were considered acceptable, allowing more zeolite topologies to be categorized into only a handful of groups. The following categories of zeolites were reported: chain or fibrous zeolites, singly connected 4-ring chains, doubly connected 4-ring chains, 6-ring zeolites, hexagonal sheets with handles, and the heulandite group which included heulandite, clinoptilolite, stilbite and its variants, and brewsterite [17].

Zeolites are very useful minerals. They have been used in various industries recently. This is due to their many attractive characteristics. There are three main uses of zeolites in industry: catalysis, adsorption, and ion exchange.

Zeolites have been used extensively as catalysts. The microporous nature gives zeolite a high surface area where reactions can take place. Because of the shape-selective nature of zeolite, they are sometimes referred to as shape-selective catalysts [10]. The main industrial application areas are: petroleum refining, fuel production, and petrochemical production. Synthetic zeolites are the most important catalysts in petrochemical refineries.

Zeolite contains water molecules and cations; when water is removed from zeolite, empty voids are created within its framework, which can be occupied by other molecules. The occupation of these voids by other molecules is called adsorption [10]. Zeolites are used to adsorb various materials, because of which they can be of use in drying, purification, and separation processes. A widely used property of zeolites is that of gas separation. Other applications that can take place within the pore include polymerization of semiconducting materials and conducting polymers to produce materials having unusual physical and electrical attributes.

The zeolite structure contains exchangeable cations ( $K^+$ ,  $Na^+$ ,  $Ca^{+2}$ ,  $Mg^{+2}$ ), which are readily exchanged with other types of cations from solution. The alkali metals such as Na or K can be moved out of the zeolite and can be replaced by the "hard" Ca and Mg ions from the water. This property of zeolite has been exploited in a major way in water softening.

Application of zeolite has been found to be attractive in the removal of heavy metals from waste water. In agronomy, horticulture, and soil remediation zeolites can be added to increase fertilizer efficiency and to reduce the leaching of nutrients. Zeolites can also be added as animal feed supplements. Their molecular sieve properties are used to trap or separate gases in agriculture (e.g. ammonia) and to treat effluents containing radioactive contaminants or other heavy metals.

Application of zeolites in waste water treatment is very important. The properties that make natural zeolite an attractive alternative for the treatment of waste water are as follows: They are cheap since they are relatively abundant [18]. They have a favorable cation exchange capacity (CEC) [19]. They have good selectivity for cations [20]. Zeolites have a high surface area due to their porous and rigid structure [21]. They also act as molecular sieves, and this property can easily be modified to increase the performance of the zeolite [22]. In acidic conditions, the zeolites have good structural stability and can be regenerated easily. The acidic solutions can be neutralized by zeolite, which is achieved through the exchange of  $H^+$  ions from solution with the cations in the zeolite structure [23].

Because of these features, zeolites have been a growing interest in the adsorption of heavy metals from solution. Many researchers have shown the feasibility of using natural zeolite in the adsorption of heavy metals under different experimental conditions such as temperature, pH, concentration, and agitation speed [8, 10, 24].

#### 1.1.1. Clinoptilolite

Clinoptilolite belong to clinoptilolite series minerals and is the most common zeolite.

These minerals occur in rocks and sediments formed in continental accumulations, deep sea sediments, and in some lava-flow sections [25].

Clinoptilolite occur as fine-grained crystals in massive beds, and important deposits of clinoptilolite occur in several countries: Bulgaria, Mexico, Hungary, Cuba, Italy, Jordan, United States, and Russia.

The origin and use of the name clinoptilolite has a convoluted history, from 1890. The clinoptilolite series comprises three species: Clinoptilolite-K (Clinoptilolite with K-dominant crystals— $(\text{K}, \text{Na}, \text{Ca}_{0.5}, \text{Sr}_{0.5}, \text{Ba}_{0.5}, \text{Mg}_{0.5})_6 (\text{H}_2\text{O})_{20} | [\text{Al}_6 \text{Si}_{30} \text{O}_{72}]$ ) is the name for the original material from the ridge east of Hoodoo Peak, Wyoming; Clinoptilolite-Na ( $(\text{Na}, \text{K}, \text{Ca}_{0.5}, \text{Sr}_{0.5}, \text{Ba}_{0.5}, \text{Mg}_{0.5})_6 (\text{H}_2\text{O})_{20} | [\text{Al}_6 \text{Si}_{30} \text{O}_{72}]$ ) is the name for Na-dominant crystals with the suggested type example from the Barstow formation, San Bernardino County, California, USA; Clinoptilolite-Ca ( $(\text{Ca}_{0.5}, \text{Na}, \text{K}, \text{Sr}_{0.5}, \text{Ba}_{0.5}, \text{Mg}_{0.5})_6 (\text{H}_2\text{O})_{20} | [\text{Al}_6 \text{Si}_{30} \text{O}_{72}]$ ) for Ca-dominant samples with type examples from Kuruma Pass, Fukus hima Prefecture, Japan.

Clinoptilolite has the same tetrahedral framework like that of heulandite [16] and form a continuous compositional series, sometimes referred to as the heulandite group zeolites. The crystal structures of clinoptilolite and heulandite are mostly described to be monoclinic, space group  $C2/m$ , but lower symmetries such as  $Cm$  and  $C1$  have also been reported [16]. The framework contains three sets of intersecting channels all located in the (010) plane. Two of the channels are parallel to the  $c$ -axis: the A channels are formed by strongly compressed 10-membered rings (aperture  $3.0 \times 7.6 \text{ \AA}$ ), and B channels are confined by 8-membered rings (aperture  $3.3 \times 4.6 \text{ \AA}$ ). C channels are parallel to the  $a$ -axis, or [102] and are also formed by 8-membered rings (aperture  $2.6 \times 4.7 \text{ \AA}$ ) (Figure 2) [26].

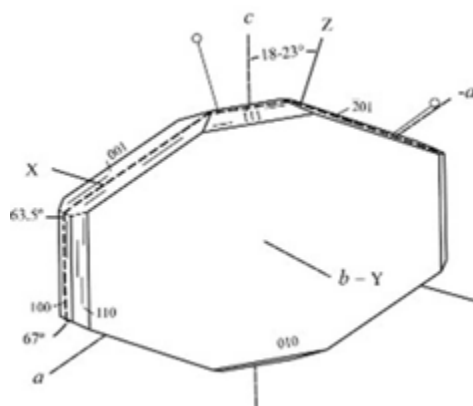

Figure 2. Crystallography of clinoptilolite.

The other characteristics of clinoptilolite are as follows: It is colorless, white, pink, yellow, reddish, or pale brown. Crystals are transparent to translucent. Cleavage is perfect in one direction, parallel to the prominent pinacoid face. Fracture is uneven. Hardness is 3.5–4, maybe softer on cleavage surfaces. Specific gravity is approximately 2.2 (very light).

### 1.1.2. Stilbite

The name, stilbite, is derived from the Greek word for mirror in allusion to its luster on the cleavage plane. The occurrences of stilbite are mentioned since 1801 by Häuy. According to Coombs [27], stilbite-Ca is the name for the original material, in which Ca is the most abundant

nonframework cation and stilbite-Na is a species with the type example from Capo Pula, Cagliari, Sardinia, Italy [28].

Stilbite-Ca is a common zeolite, while stilbite-Na is rare. Stilbite-Ca occurs in fractures and other cavities in basaltic rocks. Stilbite-Ca occurs as a vein mineral in diagenetically altered or metamorphosed volcanoclastic rocks. It also occurs as a vein mineral cutting nonvolcanic rocks, such as pegmatite, gneiss, schist, or granite.

The framework type [16, 28] of the stilbite group, which includes stilbite series, stellerite, and barrerite, consists of two sets of connected channels. One channel extends parallel to the  $a$ -axis and is confined by a 10-membered ring (aperture  $4.9 \times 6.1 \text{ \AA}$ ). The other channel (aperture  $2.7 \times 5.6 \text{ \AA}$ ) is located along [101] for monoclinic frameworks or along [001] for orthorhombic structure, and is confined by an 8-membered ring. Both of these channels are in the (010) plane, creating a structural weakness across the plane leading to perfect (010) cleavage and a tabular habit (Figure 3).

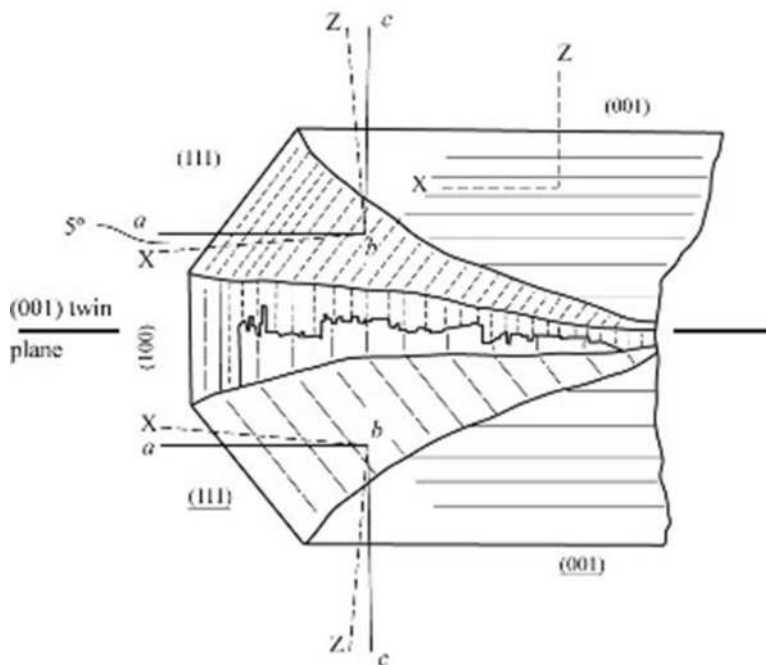

Figure 3. Crystallography of stilbite.

The other characteristics of stilbite are: the color is pink or white, and also tinted yellow and red; luster is vitreous to pearly, especially on the prominent pinacoid and cleavage surfaces; crystals are transparent to mostly translucent; cleavage is perfect in one direction, parallel to the prominent pinacoid; fracture is uneven; hardness is 3.5–4; and specific gravity is approximately 2.2 (very light).

## 1.2. Heavy metals

### 1.2.1. Lead

Lead is a heavy, low-melting, bluish-gray metal that occurs naturally in the Earth's crust. However, it is rarely found naturally as a metal. It is usually found combined with two or more other elements to form lead compounds.

Lead can enter the environment through releases from mining lead and other metals, and from factories that make or use lead, lead alloys, or lead compounds. Once lead gets into the atmosphere, it may travel long distances, if the lead particles are very small. Lead is removed from the air by rain and by particles falling to land or into surface water, but in small amounts. Lead is commonly found in soil, especially near roadways, mining areas, industrial sites, near power plants, incinerators, landfills, and hazardous waste sites. Sources of lead in surface water or sediments include deposits of lead-containing dust from the atmosphere, waste water from industries that handle lead (primarily iron and steel industries and lead producers), urban runoff, and mining piles.

People who live and work near hazardous waste sites may be exposed to lead by breathing air, drinking water, eating foods, or swallowing dust or dirt that contain lead. Once this lead gets into the lungs, it travels quickly to other parts of the body in the blood and organs (such as the liver, kidneys, lungs, brain, spleen, muscles, and heart). After several weeks, most of the lead moves into the bones and teeth and stay there for decades. The main target for lead toxicity is the nervous system. Long-term exposure results in decreased functions of the nervous system. Exposure to lead can cause weakness in fingers, wrists, or ankles, small increases in blood pressure, anemia, and severe damage to the brain and kidneys [29].

### 1.2.2. Zinc

Zinc is one of the most common elements in the Earth's crust. Zinc is present in air, soil, and water, and in all foods.

Zinc can enter the environment through releases from mining, purifying of zinc, lead, and cadmium ores, steel production, coal burning, burning of wastes, zinc chemical industries, and domestic waste water. Sludge and fertilizers also contribute to increased concentration of zinc in the soil. All these sources can increase the concentration of zinc in the atmosphere, soil, and water. In air, zinc is present mostly as fine dust particles, which settle over land and water.

Zinc is an essential element needed by human body in small amounts. Humans are exposed to zinc compounds in food. Zinc can enter the body through the digestive tract when you eat food or drink water containing it. Zinc can also enter through lungs if zinc dust or fumes from zinc-smelting or zinc-welding operations is inhaled. Zinc is stored throughout the body. The concentration of zinc increases in blood and bone rapidly after exposure, may stay in the bone for many days, and leave the body in urine and feces. Inhaling large amounts of zinc (as zinc dust or fumes from smelting or welding) can cause a specific short-term disease called metal fume fever, which is generally reversible once exposure to zinc ceases [30].



## 2. Characteristics of materials

Particle characterization reveals information on the physical and chemical nature of natural zeolite particles, which is related to its ability to remove heavy metal ions from solution.

Two types of natural raw materials were used in a recent study for removal of heavy metals such as lead and zinc. The first of them was natural zeolite from Kardjali, Republic of Bulgaria. The second natural raw material was zeolite bearing tuff from Vetunica deposits, localized in the northern marginal parts of the well-known Kratovo-Zletovo volcanic area in the Republic of Macedonia. The particle size range of the natural raw materials used in this study was 0.8–2.5 mm.

The general characteristics of used materials, such as chemical composition, physical characteristics, and cation exchange capacity are presented in **Tables 1, 2, and 3**, respectively.

Chemical composition (%)	Natural zeolite	Zeolite bearing tuff
SiO <sub>2</sub>	69.68	54.67
Al <sub>2</sub> O <sub>3</sub>	11.40	20.16
Fe <sub>2</sub> O <sub>3</sub>	0.93	–
CaO	2.01	4.86
MgO	0.87	1.08
K <sub>2</sub> O	2.90	2.40
TiO <sub>2</sub>	0.15	0.45
Na <sub>2</sub> O	0.62	1.97
MnO	0.08	0.06
H <sub>2</sub> O	13.24	–
P <sub>2</sub> O <sub>5</sub>	0.02	0.24
NaO	–	–
FeO	–	3.98

**Table 1.** Chemical composition of natural raw materials.

	Hydrated density (g/cm <sup>3</sup> )	Dehydrated density (g/cm <sup>3</sup> )	Porosity (%)
Natural zeolite	2.31	1.84	20.20
Zeolite bearing tuff	1.72	0.89	48.40

**Table 2.** Density and porosity of natural raw materials.

Chemical composition (%)	Natural zeolite	Zeolite bearing tuff
K <sup>+</sup>	41 mEq/100g	66.5 mEq/100g
Na <sup>+</sup>	16.10 mEq/100g	3.5 mEq/100g
Ca <sup>2+</sup>	67.14 mEq/100g	21.5 mEq/100g
Mg <sup>2+</sup>	3.88 mEq/100g	8.5 mEq/100g
Total cation exchange capacity	1.8–2.2 mEq/g	0.69–1.07 mEq/g

**Table 3.** Cation exchange capacity.

X-Ray Diffractometer 6100 from Shimadzu was used to investigate the mineralogical structure of natural raw material samples. This technique is based on observing the scattering intensity of an X-ray beam hitting a sample as a function of incident and scattered angle, polarization, and wavelength or energy. The diffraction data obtained are compared with the database maintained by the *International Centre for Diffraction Data*, in order to identify the material in the solid samples. The results of XRD are presented in **Figures 4** and **5**.

**Figure 4** presented the sample taken from Kardjali, Bulgaria, and showed that natural zeolite contained majority (90–94%) of clinoptilolite.

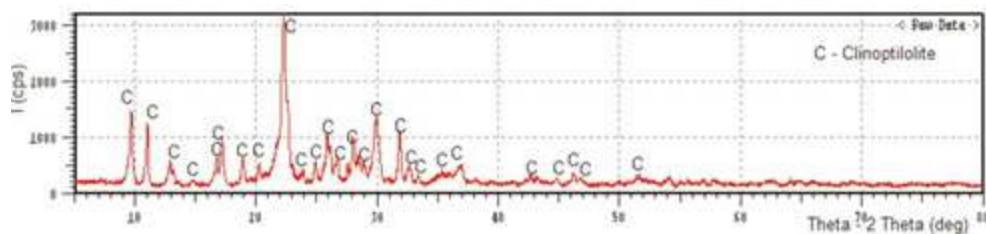

**Figure 4.** X-ray diffraction of a sample from Kardjali, Bulgaria.

The second sample is taken from Vetunica deposit, Kratovo, Macedonia, and is presented in **Figure 5**. The result showed that this sample contained about 27% stilbite ( $\text{NaCa}_2\text{Al}_5\text{Si}_{13}\text{O}_{36} \cdot 14\text{H}_2\text{O}$ ) and that the rest were albite, anorthite, kaolinite, and quartz. This analysis confirms the results obtained from the study of Blazev [31], where Diffractometer PHILIPS, type PW 1051, was used for the determination of the mineralogical composition.

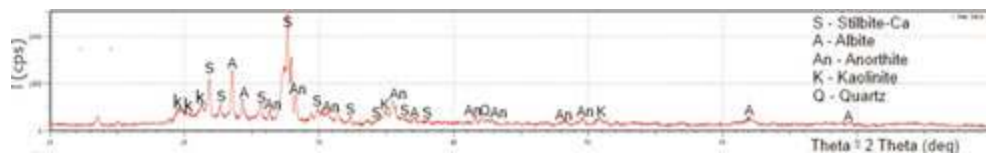

**Figure 5.** X-ray diffraction of sample from Vetunica, Kratovo, Macedonia.

Scanning electron microscope, VEGA3 LMU, fitted with an Inca 250 EDS (Energy-Dispersive Spectroscopy) system, is used to study the surface morphology of natural raw material samples. The elemental analysis of a sample is based on the emission of characteristic X-rays by the sample when subjected to a high-energy beam of charged particles such as electrons or protons. Micrographs of natural raw material samples are shown in **Figures 6** and **7**. The micrographs clearly show numerous macropores and well-defined crystals of clinoptilolite and stilbite in the zeolite structure in both the samples.

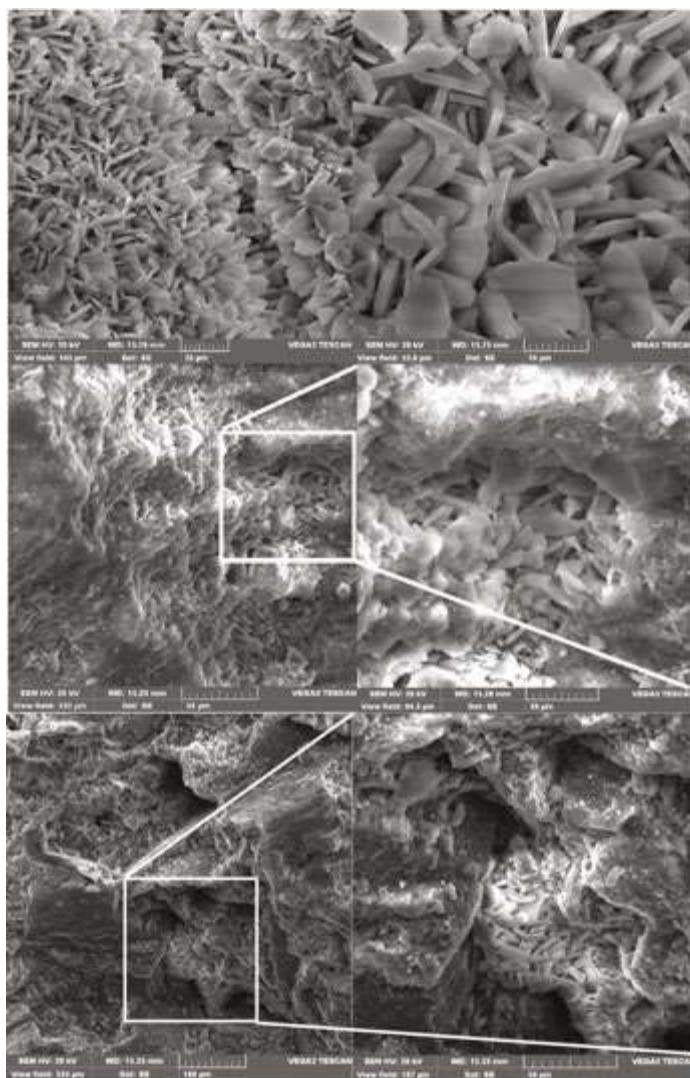

**Figure 6.** Micrographs of natural zeolite samples obtained from SEM analysis.

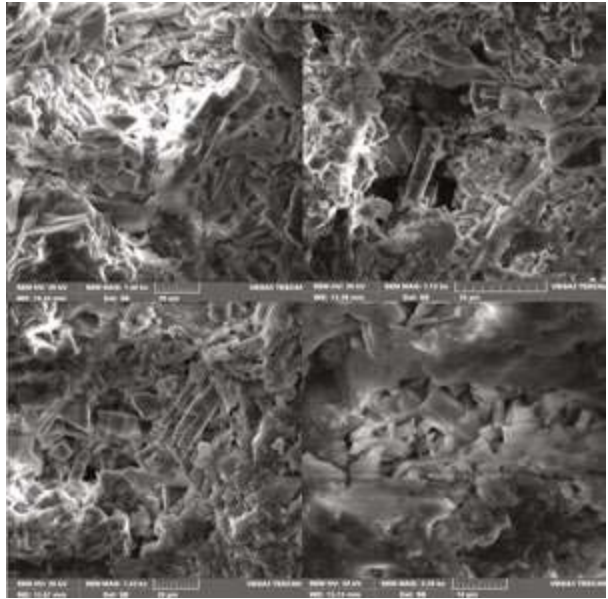

Figure 7. Micrographs of zeolite bearing tuff samples obtained from SEM analysis.

An electron beam was directed onto different parts of the samples in order to get a more accurate analysis (Figure 8). Obtained elemental compositions of natural zeolite—clinoptilolite and zeolite bearing tuff—stilbite are presented in Table 4.

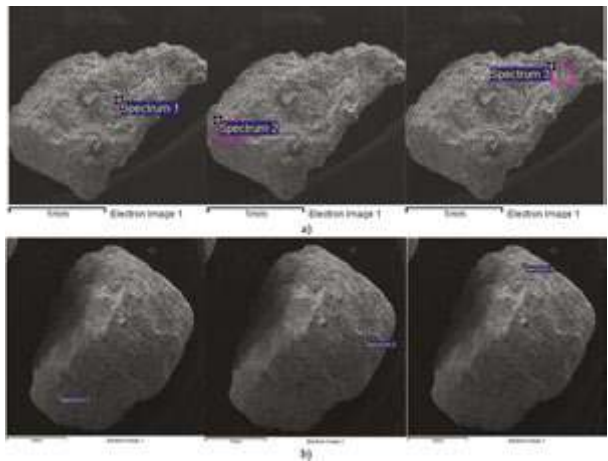

Figure 8. EDS analysis showing the scanning method for natural raw material samples: (a) Natural zeolite—clinoptilolite and (b) Zeolite bearing tuff—stilbite.

Element	Natural zeolite—Clinoptilolite Average (%)	Zeolite bearing tuff—Stilbite
O	57.56	61.62
Na	0.24	0.34
Mg	0.72	1.07
Al	5.28	8.13
Si	30.13	26.29
K	2.71	1.65
Ca	1.99	0.91
Fe	1.38	–
Total	100	100

**Table 4.** EDS analysis showing the elemental composition for natural raw material samples.

Results of EDS analysis showed that the predominant exchangeable cations in natural zeolite—clinoptilolite structure were  $K^+$  and  $Ca^{2+}$ , while the predominant exchangeable cation in stilbite rich tuff structure was  $K^+$ , which was then followed by  $Mg^{2+}$  and  $Ca^{2+}$ .

### 3. Effect of studied conditions

The rate of adsorption is a complex function of several factors such as initial pH and concentration of solution, mass of adsorbent, adsorbent particle size, temperature, flow rate in columns, and agitation speed in the case of batch experiments. The overall reaction rate may be influenced by separate or combined effect of these factors. In these studies, some of these factors are investigated with regard to their effect on the efficiency of natural zeolite and zeolite bearing tuff in removing lead and zinc from solutions.

For this purpose, adsorption of lead and zinc ions on natural porous mineral materials was studied with synthetic single-ion solutions of lead and zinc with different initial concentrations (5, 25, 50, 200, and 400 mg/l). Synthetic single-component solutions of these metals were prepared by dissolving a weighed mass of the analytical grade salt  $Pb(NO_3)_2$  and  $ZnSO_4 \cdot 7H_2O$ , appropriately, in 1000 ml distilled water.

Initial pH of the prepared solution was adjusted by adding 2% sulfuric acid and controlled by 210 Microprocessor pH meter. Initial pH ranges of tested solution were 2.5, 3.5, and 4.5. The experiments were performed in a batch mode in a series of beakers equipped with magnetic stirrers contacting a mass of adsorbents (2, 5, and 10 g) with a certain volume of 400 ml of metal ion solution. Magnetic stirrer at 400 rpm was used for agitation up to 360 min, at room temperature of  $20 \pm 1^\circ C$ . The final pH value was also measured. After predetermined time, the suspension was filtered, and the filtrate was analyzed using Liberty 110, ICP Emission Spectrometer, Varian. Inductively coupled plasma atomic emission spectroscopy (ICP-AES)

Agilent was used to analyze the concentration of metal ions in solution. Inductively coupled plasma atomic emission spectroscopy (ICP-AES) is an analytical technique used for the detection of trace metals. It is a type of emission spectroscopy that uses the inductively coupled plasma to produce excited atoms and ions that emit electromagnetic radiation at wavelengths characteristic of a particular element. The intensity of this emission is indicative of the concentration of the element within the sample [46, 47].

Based on material balance, the adsorption capacity was calculated by using the following expression [32]:

$$q_e = \frac{V(C_0 - C_e)}{m} \text{ (mg/g)} \quad (1)$$

where  $q_e$  is the mass of adsorbed metal ions per unit mass of adsorbent (mg/g),  $C_0$  and  $C_e$  are the initial and final metal ion concentrations (mg/dm<sup>3</sup>), respectively,  $V$  is the volume of the aqueous phase (l), and  $m$  is the mass of adsorbent used (g).

$$AD\% = \left(1 - \frac{C_e}{C_0}\right) \cdot 100 \quad (2)$$

The difference in adsorption capacity of the adsorbents for the heavy metal ions may be due to numerous factors, which include hydration radii, hydration enthalpies, and solubility of the cations. The hydration radii of the studied cations are:  $r_{\text{H}}\text{Zn}^{2+} = 4.30\text{\AA}$  and  $r_{\text{H}}\text{Pb}^{2+} = 4.01\text{\AA}$  [33, 34]. The smallest cations should ideally be adsorbed faster and in larger quantities compared to the larger cations, since the smaller cations can pass through the micropores and channels of the zeolite structure with ease [8]. Furthermore, adsorption should be described using hydration enthalpy, which is the energy that permits the detachment of water molecules from cations and thus reflects the ease with which the cation interacts with the adsorbent. Therefore, the more a cation is hydrated, the stronger its hydration enthalpy and the less it can interact with the adsorbent [10]. Divalent cations with low hydration energies are adsorbed preferably compared to cations with high hydration energies [35]. The hydration energies of the studied cations are:  $-1955$  and  $-1481$  kJmol<sup>-1</sup> for Zn<sup>2+</sup> and Pb<sup>2+</sup>, respectively [33, 34].

The lead ion has smaller hydration radius and hydration energy than zinc ion. Based on this fact it is expected that adsorption of lead ions will be better than zinc ions.

### 3.1. Effect of initial metal concentration in solution

The effect of initial concentration was investigated by contacting 5 g of adsorbent, at pH 3.5, with different concentrations of single-component solutions, 5, 25, 50, 200, and 400 mg/l. An increase in concentration generally results in an increase in the amount of heavy metals adsorbed. This may be due to an increase in the number of collisions between the reactants, leading to the observed increase in reaction rate and capacity, according to the collision theory

[36]. Increasing the initial metal concentration in solution until the system reaches a saturation point will result in increase of adsorption capacity. After reaching a saturation point, increasing the adsorbate (lead and zinc) concentration will not result in any significant change in the amount adsorbed,  $q_e$ . Results of this investigation are presented in **Table 5**.

Heavy metal ion	Adsorbent	Initial concentration $C_0$ (mg/l)	Amount adsorbed $q_e$ (mg/g)	Percentage adsorbed (%)
Lead	Natural zeolite—clinoptilolite	5	0.390	97.60
		25	1.984	99.20
		50	3.982	99.54
		200	15.642	97.76
		400	30.143	94.19
	Zeolite bearing tuff—stilbite	5	0.400	99.98
		25	2.000	100
		50	4.000	100
		200	15.500	96.9
		400	27.224	85.1
Zinc	Natural zeolite—clinoptilolite	5	0.376	94
		25	1.786	89.32
		50	2.901	72.52
		200	3.619	26.62
		400	7.263	26.69
	Zeolite bearing tuff—stilbite	5	0.3896	97.4
		25	1.937	96.84
		50	3.632	90.8
		200	13.152	82.2
		400	25.408	79.4

**Table 5.** Effect of initial solution concentration on the adsorption capacity of natural zeolite and zeolite bearing tuff.

The above results indicate that the amount of lead and zinc adsorbed by natural zeolite and zeolite bearing tuff at equilibrium is dependent on the initial metal concentration in solution. As initial concentration increases, the adsorption of lead and zinc ions by natural zeolite and zeolite bearing tuff also increases. This was expected because it is a consequence of an increase in the concentration-driving force. The concentration-driving force is important because it is responsible for overcoming the mass transfer resistance associated with the adsorption of metals from solution by the adsorbent [37].

Increase in initial metal concentration in solution not only results in an increase in the amount adsorbed ( $q_e$ ) but also a decrease in the efficiency of adsorbents used for the removal of lead and zinc from solution. This conclusion can be seen from **Table 5**. Sprynskyy et al. [22] and Motsi [10] also found a similar trend, that is, a decrease in efficiency, in their work, on the adsorption of lead, copper, nickel, and cadmium from solution by clinoptilolite [22] and on the adsorption of iron, copper, manganese, and zinc from solution by clinoptilolite [10].

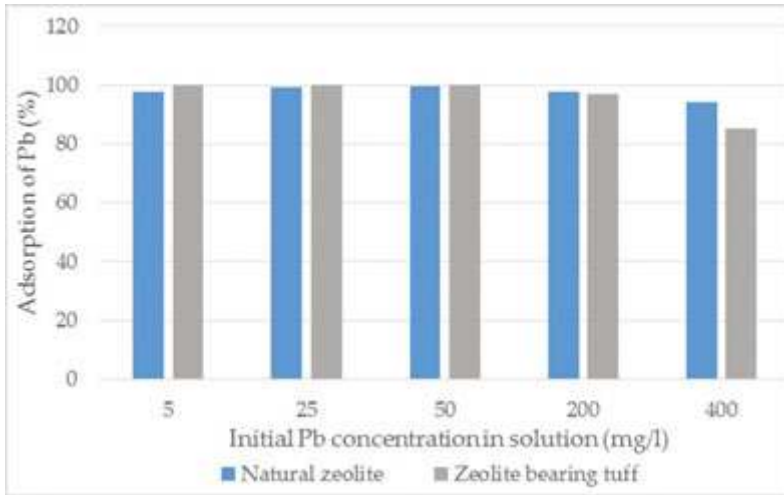

Figure 9. Adsorption of lead depending on initial metal concentration.

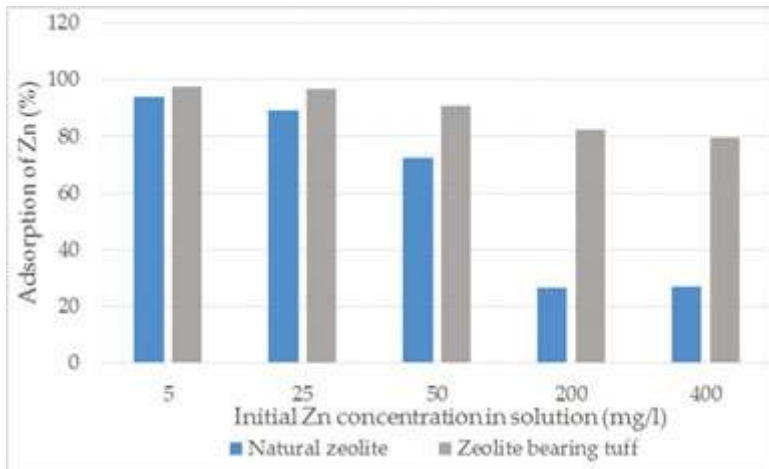

Figure 10. Adsorption of zinc depending on initial metal concentration.



By comparing the adsorbents used, natural zeolite and zeolite bearing tuff, for lead and zinc removal from solution, as shown in **Figures 9** and **10**, it can be concluded that zeolite bearing tuff is a more effective adsorbent, especially in the case of adsorption of zinc ions. In the case of adsorption of lead ions, which depends on adsorbents, significant changes are not found.

### 3.2. Effect of mass of adsorbent

The effect of mass of adsorbent was investigated by contacting 2, 5, and 10 g of adsorbent (natural zeolite or zeolite bearing tuff), at pH 3.5, with concentrations of single-component solutions of 5 mg/l Pb ions and 25 mg/l Zn ions.

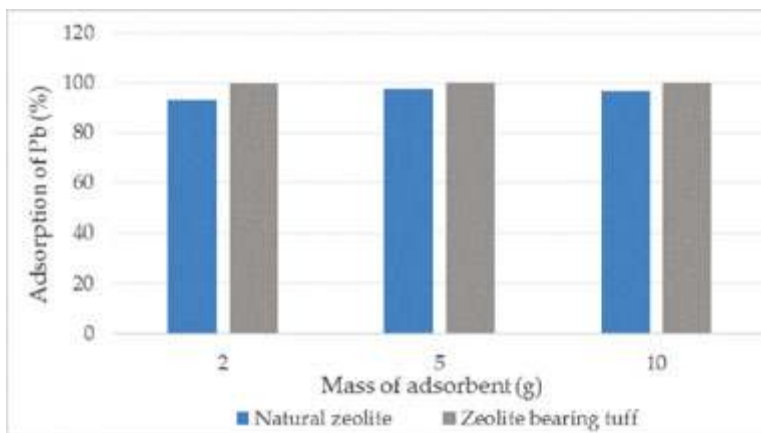

**Figure 11.** Adsorption of lead depending on the mass of adsorbents.

**Figure 12.** Adsorption of zinc depending on the mass of adsorbents.

Results from **Figures 11** and **12** show that an increase in the adsorbent mass resulted in an increase in the adsorption of the heavy metals. This was expected, because more adsorption sites are available per unit mass of adsorbent.

However, this is more apparently in the case of adsorption of zinc ions. Adsorption of lead ions increases with an increase in adsorbent mass, but less than the zinc ions.

By comparing the adsorbents used, and as shown in **Figures 11** and **12**, we come to the same conclusion, as that in the examination for the effect of initial concentration in solution, that the zeolite bearing tuff is the more effective adsorbent.

### 3.3. Effect of initial pH value of solution

The effect of initial pH of solution was investigated by contacting 5 g of adsorbent (natural zeolite or zeolite bearing tuff), at three various pH values (2.5, 3.5, and 4.5), with concentrations of single-component solutions of 5 mg/l Pb ions and 25 mg/l Zn ions.

According to Low et al., less adsorption at lower pH could be ascribed to hydrogen ions competing with the metal ions for adsorption sites [38]. This means that the adsorbent surface becomes more positively charged at higher  $H^+$  concentration, thus reducing the attraction between the adsorbent and metal ions. Contrary to this, with increasing pH value, the adsorbent surface becomes more negatively charged, thus facilitating greater metal uptake [1].

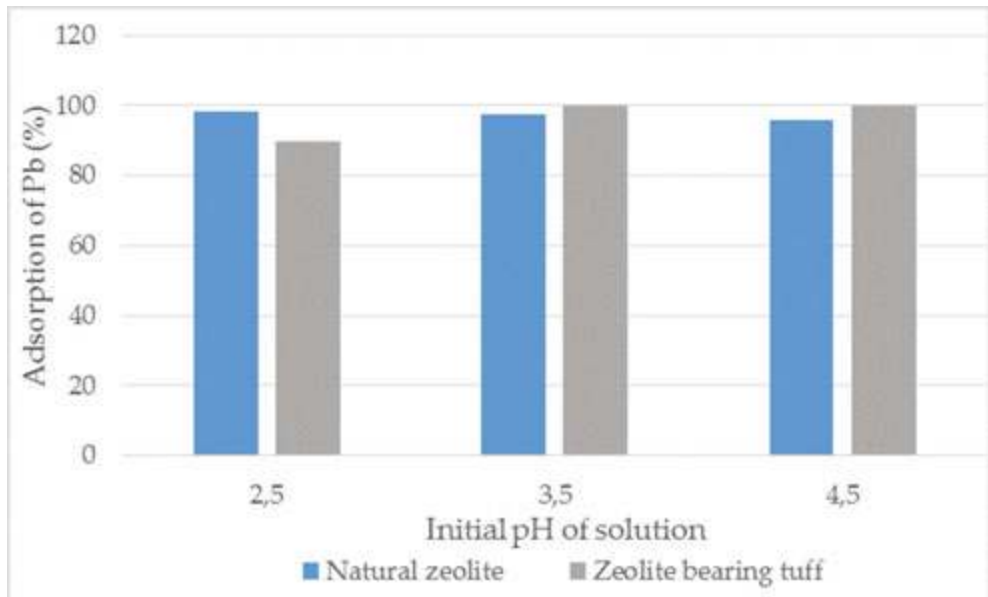

**Figure 13.** Adsorption of lead depending on initial pH value of solution.

**Figure 14.** Adsorption of zinc depending on initial pH value of solution.

As expected, as pH of a solution decreases, lead and zinc removal efficiency also decreases. This is because  $H^+$  ions compete with lead and zinc cations for the same exchange sites [21], and the electrostatic repulsion between the lead and zinc cations in solution and the protonated zeolite surface increases as more  $H^+$  ions are adsorbed [7].

**Figures 13 and 14** show how the adsorption capacity of natural zeolite and zeolite bearing tuff is affected by the solution's pH. Similar results on the efficiency of metal adsorption, dependent on the pH levels of solution, have been obtained by Moreno et al. [39], Alvarez-Ayuso et al. [21], and Motsi [10].

By comparing the adsorbents, we come to the same conclusion that zeolite bearing tuff has better adsorption than natural zeolite. The greater adsorption of heavy metals onto zeolite bearing tuff—stilbite compared to natural zeolite—clinoptilolite may be due to the higher porosity of zeolite bearing tuff.

#### 4. Equilibrium studies

Equilibrium studies generally involve the determination of the adsorption capacity of a given material. This determination is important in accessing the potential of the material as an economic and commercially viable adsorber.

Adsorption will occur upon contacting an adsorbent with solutions containing an adsorbate. Until equilibrium is established between the adsorbate in solution and the adsorbed state, adsorption will continue. At equilibrium, a relationship exists between the concentration of the adsorbate in solution and the "concentration" of the adsorbate in the adsorbed state (i.e., the amount of adsorbed per unit mass of adsorbent) [40].

Determination of the maximum capacity of used adsorbents, natural zeolite and zeolite bearing tuff, for removal of lead and zinc ions from solution was the main objective of the equilibrium studies.

Experimental data were fitted to conventional adsorption mathematical models, namely the Freundlich and Langmuir models. These were used to predict the adsorption performance of natural zeolite and zeolite bearing tuff.

#### 4.1. Langmuir's model

The Langmuir isotherm model [41], based on monolayer coverage of adsorbent surfaces by the adsorbate at specific homogeneous sites within the adsorbent, is represented as

$$q_a = \frac{q_m K_l C_e}{1 + K_l C_e} \quad (3)$$

where  $q_e$  (mg/g) is the amount of solute adsorbed per unit mass of adsorbent at equilibrium;  $C_e$  (mg/dm<sup>3</sup>) is the residual adsorbate concentration in solution at equilibrium;  $q_m$  (mg/g) is the amount of solute adsorbed per unit mass of adsorbent corresponding to complete coverage of available sites;  $K_l$  (dm<sup>3</sup>/mg) is the Langmuir adsorption coefficient, and this constant is related to the affinity between the adsorbent and solute, which is evaluated through linearization of Eq. (4):

$$\frac{1}{q_a} = \frac{1}{k_l q_m C_e} + \frac{1}{q_m} \quad (4)$$

The essential characteristics of Langmuir isotherm can be described by a dimensionless constant called equilibrium parameter,  $R_L$ , which is usually defined by

$$R_L = \frac{1}{(1 + K_l + C_0)} \quad (5)$$

where  $K_l$  is the Langmuir constant that indicates the nature of adsorption and  $C_0$  is the highest initial metal concentration (mg/l). The value of  $R_L$  indicates the type of the adsorption isotherm to be either irreversible ( $R_L = 0$ ), favorable ( $0 < R_L < 1$ ), linear ( $R_L = 1$ ), or unfavorable ( $R_L > 1$ ).

#### 4.2. Freundlich's model

The Freundlich isotherm model, based on monolayer adsorption on heterogeneous surfaces with a nonuniform distribution of adsorption heat, is represented as

$$q_a = k_f C_e^{1/n} \quad (6)$$

where  $k_f$  and  $n$  are empirical Freundlich constants that are dependent on experimental conditions.  $k_f$  (mg/g) is an indicator of adsorption capacity, while  $n$  (g/dm<sup>3</sup>) is related to the adsorption intensity or binding strength. Their values were determined from the linear form of the Freundlich equation, given by

$$\log q_d = \log k_f + \frac{1}{n} \log C_e \tag{7}$$

where  $1/n$  is the heterogeneity factor; values of  $1/n \ll 1$  indicate heterogeneous adsorbents, while values closer to or even 1 indicate a material with relatively homogeneous binding sites [42]. Natural zeolite should be a heterogeneous adsorbent due to its porous nature. Alvarez-Ayuso et al. [21], Avila [43], and Gunay et al. [44] successfully used the Freundlich adsorption isotherm to model their results from equilibrium experiments.

### 4.3. Equilibrium experiments

Equilibrium experiments, the main objective of which was to determine the maximum capacity of adsorbents used, natural zeolite and zeolite bearing tuff, in removal of lead and zinc ions from solution, were done by contacting 5 g adsorbent at pH 3.5 and temperature of  $20 \pm 1^\circ\text{C}$  with different concentrations of single-component solutions of 5, 25, 50, 200, and 400 mg/l of Pb<sup>2+</sup> and Zn<sup>2+</sup>.

Experimental data obtained from equilibrium experiments were fitted to the Langmuir and Freundlich adsorption isotherms. The values of the parameters for the two isotherms are presented in **Table 6**.

		Lead		Zinc	
		Natural zeolite	Zeolite bearing tuff	Natural zeolite	Zeolite bearing tuff
Experimental	$q_e$ (mg/g)	30.14	27.224	3.6392	25.408
	$C_e$ (mg/l)	21.21	89.7	218.04	82.4
Langmuir	$q_m$ (mg/g)	37.59	27.548	3.7272	29.0698
	$k_f$ (l/mg)	0.1726	0.8875	0.0968	0.0464
	$R_L$	0.0143	0.0028	0.025	0.0511
	$R^2$	0.8853	0.9937	0.99	0.845
Freundlich	$k_f$ (l/mg)	1.1628	9.3154	0.3934	1.6118
	$1/n$	0.6803	0.2667	0.4545	0.6128
	$n$ (g/l)	1.4699	3.7495	2.2002	1.6319
	$R^2$	0.8346	0.7525	0.9111	0.9849

**Table 6.** Calculated equilibrium adsorption isotherm constants for the uptake of lead and zinc from solution by natural zeolite and zeolite bearing tuff.

According to the Freundlich model, values of the heterogeneity factor,  $1/n$ , indicate that natural zeolite and zeolite bearing tuff are heterogeneous adsorbents, because the value of the heterogeneity factor is  $\ll 1$ . Based on the correlation coefficients ( $R^2$ ), the adsorption isotherms can be better described by the Langmuir model. The applicability of the Langmuir isotherm suggests monolayer coverage of the  $\text{Pb}^{2+}$  and  $\text{Zn}^{2+}$  at the surface of the zeolites or that a similar exchangeable ion with equivalent concentration was exchanged by  $\text{Pb}^{2+}$  and  $\text{Zn}^{2+}$ . The  $R_L$  values reported in **Table 6** show that the behavior of  $\text{Pb}^{2+}$  and  $\text{Zn}^{2+}$  adsorption onto the adsorbents used was favorable ( $0 < R_L < 1$ ).

Adsorption isotherms obtained according to the Langmuir and Freundlich models are compared with experimental data and are shown in **Figures 15** and **16** for the adsorption of lead and in **Figures 17** and **18** for the adsorption of zinc from the solutions of both the adsorbents used.

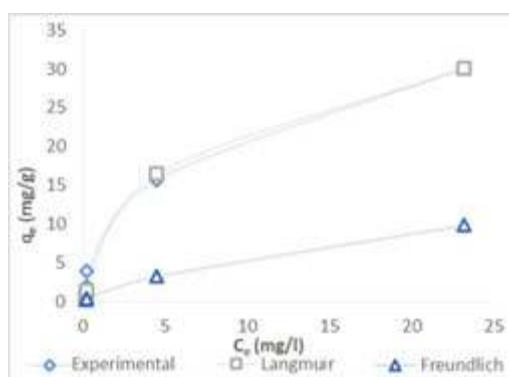

**Figure 15.** Equilibrium isotherms for Pb adsorption onto natural zeolite—clinoptilolite.

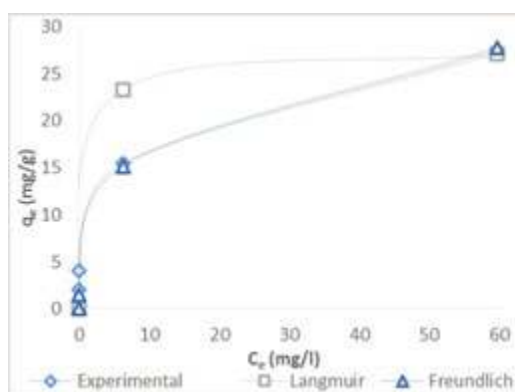

**Figure 16.** Equilibrium isotherms for Pb adsorption onto zeolite bearing tuff—stilbite.

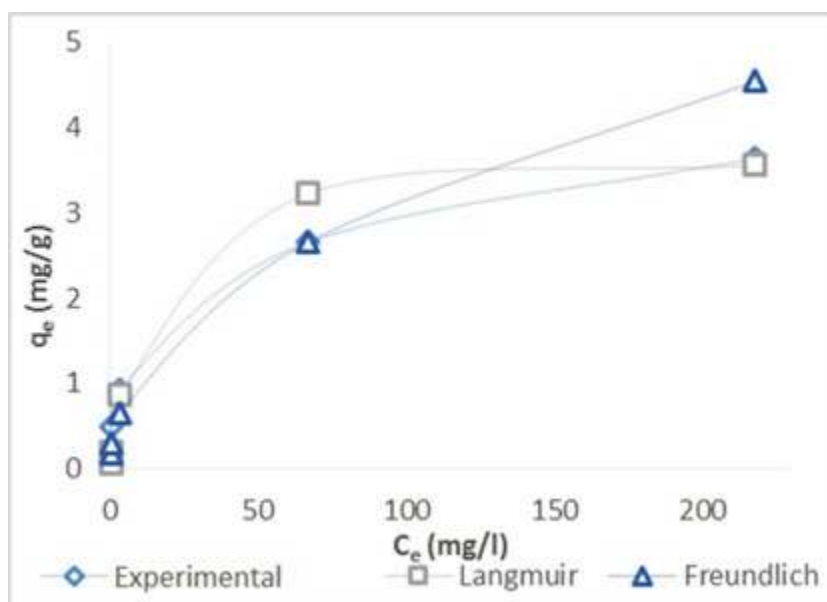

Figure 17. Equilibrium isotherms for Zn adsorption onto natural zeolite—clinoptilolite.

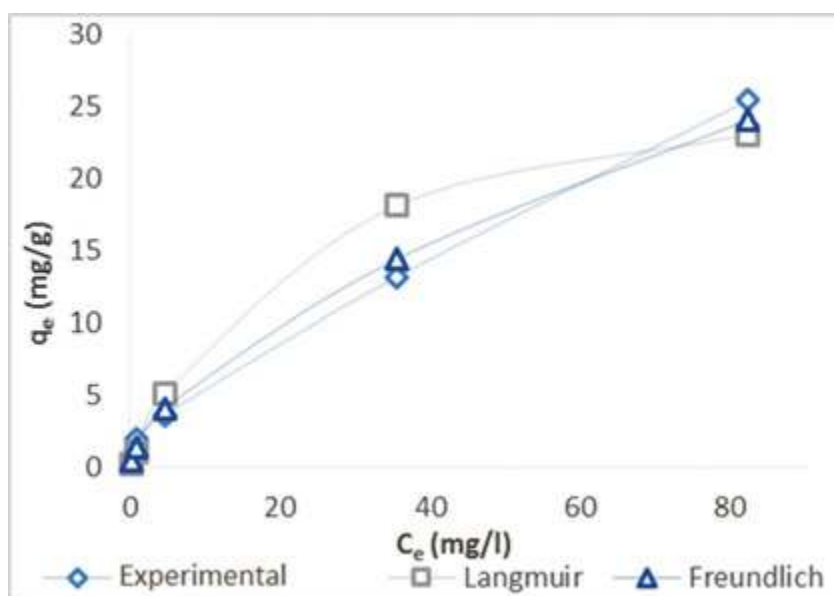
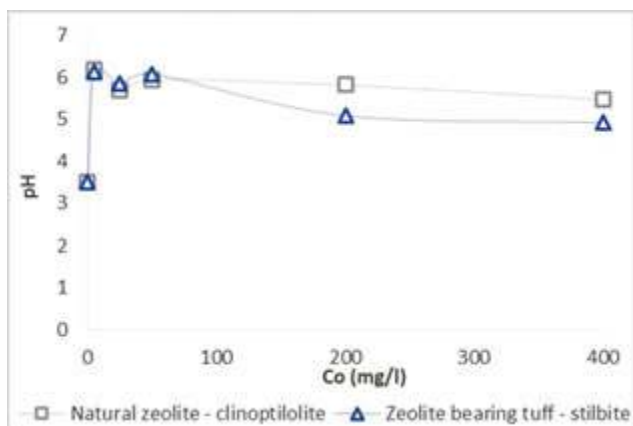

Figure 18. Equilibrium isotherms for Zn adsorption onto zeolite bearing tuff—stilbite.

The results shows that as the initial concentration of heavy metal cations increases, the amount of metal adsorbed per gram of adsorbent ( $q_e$ ) increases. This is mainly due to the fact that at high metal concentrations, there is a higher solute concentration gradient, and this provides the necessary driving force for metal ions to displace exchangeable cations on the surface and from the internal micropores of natural zeolite [10, 45]. However, this increasing trend is valid up to a point at which the maximum capacity of the adsorbent samples for the respective heavy metal cation is achieved, that is, its saturation point.

**Figures 19** and **20** present the variation in the equilibrium pH values with respect to initial metal concentration in each equilibrium study.



**Figure 19.** Equilibrium pH change with respect to various initial lead concentrations.

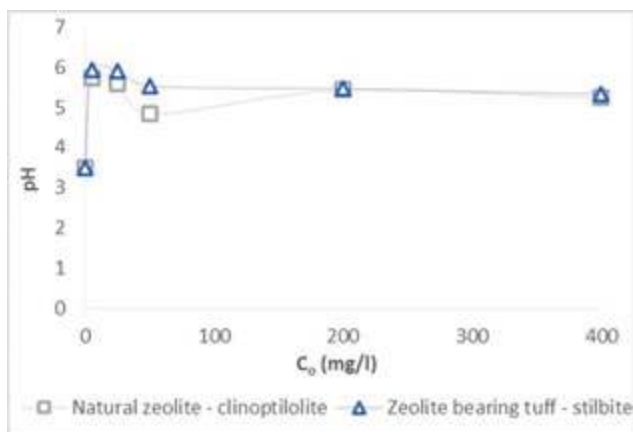

**Figure 20.** Equilibrium pH change with respect to various initial zinc concentrations.



By measuring the pH value before and after treatment, it can be concluded that the pH values at equilibrium are greater than initial pH values. The difference between equilibrium pH and initial pH exhibits a descending trend with increasing initial metal concentration. The adsorption of  $H^+$  ions from solution will cause increase in pH value. As the initial concentration of metal increases, the concentration-driving force begins to favor the adsorption of metal ions in preference to  $H^+$  ions, and thus the descending trend of the equilibrium pH at higher initial metal concentrations.

That natural zeolite has a buffering effect has been proven by many authors, including Erdem [8] and Motsi [10]. According to the results obtained from this research, it can be confirmed that not only natural zeolite—clinoptilolite but also zeolite bearing tuff—stilbite has a buffering effect.

## 5. Conclusion

The adsorption of heavy metal ions from diluted solution may occur efficiently onto porous materials. The studied natural raw materials which belong to the zeolite group are porous minerals with high adsorption capacity. Porosity of zeolite bearing tuff—stilbite (48.40%) is higher than the porosity of natural zeolite—clinoptilolite (20.20%), whereas the total cation exchange capacity of natural zeolite—clinoptilolite (1.8–2.2 mEq/g) is higher than that of zeolite bearing tuff—stilbite (0.69–1.07 mEq/g).

The adsorption of lead and zinc ions from diluted solution onto natural zeolite and zeolite bearing tuff occurs efficiently.

Regarding heavy metals, adsorption of lead ions is better than zinc ions. As expected, the results confirmed that ions with smaller hydration radius and hydration energy are better adsorbed on the studied porous raw materials. Adsorption of lead ions was found to be dependent on the pH of the solution, mass of adsorbents, and initial lead concentration in solution in the studied range. The adsorption of zinc ions is also efficient, but it is dependent on the conditions studied. It is most effective at lower concentration of zinc ions, higher mass of adsorbents, and higher pH value of the solution.

By comparing the studied adsorbents, it can be concluded that zeolite bearing tuff adsorbs better than natural zeolite. The greater adsorption of heavy metals onto zeolite bearing tuff—stilbite, when compared to natural zeolite—clinoptilolite, may be due to the higher porosity of zeolite bearing tuff.

Equilibrium studies show that adsorption of lead and zinc ions strongly depends on the initial concentration. As the initial concentration of heavy metal cations increases, the amount of metal adsorbed per gram of adsorbent ( $q_e$ ) increases.

The Langmuir isotherms for the adsorption of lead and zinc from solution gave better fits of the experimental results than the Freundlich isotherms.

## Author details

Mirjana Golomeova and Afrodita Zendelska\*

\*Address all correspondence to: afrodita.zendelska@ugd.edu.mk

Goce Delcev University, Stip, Macedonia

## References

- [1] Gamze Turan N., Mesci B., "Adsorption of Copper(II) and Zinc(II) ions by various agricultural by-products. Experimental studies and modelling," *Environment Protection Engineering*, vol. 31, no. 4, pp. 143–161, 2011.
- [2] Kobya M., Demirbas E., Senturk E., Ince M., "Adsorption of heavy metal ions from aqueous solutions by activated carbon prepared from apricot stone," *Bioresource Technology*, vol. 96, no. 13, pp. 1518–1521, 2005.
- [3] Ammann L., Cation exchange and adsorption on clays and clay minerals, Dissertation, Christian-Albrechts-Universität, Kiel, 2003.
- [4] Sag Y., Aktay Y., "Mass transfer and equilibrium studies for the sorption of chromium ions onto chitin," *Process Biochemistry* vol. 36, pp. 157–173, 2000.
- [5] Rahmani A. R., Mahvi A. H., Mesdaghinia A. R., Nasseri S., "Investigation of ammonia removal from polluted waters by Clinoptilolite zeolite," *International Journal of Environmental Science & Technology*, vol. 1, no. 2, pp. 125–133, 2004.
- [6] Buasri A., Chaiyut N., Phattarasirichot K., Yongbut P., Nammueg L., "Use of natural clinoptilolite for the removal of Lead (II) from wastewater in batch experiment," *Chiang Mai Journal of Science*, vol. 35, no. 3, pp. 447–456, 2008.
- [7] Cabrera C., Gabaldon C., Marzal P., "Sorption characteristics of heavy metal ions by a natural zeolite," *Journal of Chemical Technology and Biotechnology*, vol. 80, pp. 477–481, 2005.
- [8] Erdem E., Karapinar N., Donat R., "The removal of heavy metal cations by natural zeolites," *Journal of Colloid and Interface Science*, vol. 280, no. 2, pp. 309–314, 2004.
- [9] Taffarel S. R., Rubio J., "On the removal of  $Mn^{2+}$  ions by adsorption onto natural and activated Chilean zeolites," *Minerals Engineering*, vol. 22,, pp. 336–343, 2009.
- [10] Motsi T., Remediation of acid mine drainage using natural zeolite, The University of Birmingham, 2010.
- [11] Zendelska A., Golomeova M., Blažev K., Boev B., Krstev B., Golomeov B., A, Krstev, "Kinetic studies of manganese removal from aqueous solution by adsorption on natural

- zeolite," *Macedonian Journal of Chemistry and Chemical Engineering*, vol. 34, no. 1, pp. 1857–5625, 2015.
- [12] Lobo J.A.C., Heterogeneous asymmetric epoxidation of cis-ethyl cinnamate over Jacobsen's catalyst immobilized in inorganic porous materials, RWTH Aachen University, Germany, 2005.
- [13] Peskov M., "Zeolites," 2015. [Online]. Available: <http://www.asdn.net/asdn/chemistry/zeolites.shtml>.
- [14] McCusker Lynne B., C. Baerlocher, "Zeolite structures," in *Introduction to Zeolite Science and Practice*, Elsevier, 2001.
- [15] Payra P., Dutta P. K., "Zeolites: A primer," in *Handbook of Zeolite Science and Technology*, Marcel Dekker, 2003.
- [16] Baerlocher C., Meier W. H., Olson D. H., *Atlas of Zeolite Framework Types*, 6th Edition, Elsevier, 2007.
- [17] Szostak R., *Molecular Sieves: Principles of Synthesis and Identification*, 2nd Edition, Thomson Science, 1998.
- [18] Cui H., Li L.Y., Grace J.R., "Exploration of remediation of acid rock drainage with clinoptilolite as sorbent in a slurry bubble column for both heavy metal capture and regeneration," *Water Research*, vol. 40, pp. 3359–3366, 2006.
- [19] Yuan G., Seyama H., Soma M., Theng B.K.G., Tanaka A., "Adsorption of some heavy metals by natural zeolites: XPS and batch studies," *Journal of Environmental Science and Health*, vol. 34, pp. 625–648, 1999.
- [20] Malliou E., Loizidou M., Spyrellis N., "Uptake of lead and cadmium by clinoptilolite," *Science of the Total Environment*, vol. 149, pp. 139–144, 1994.
- [21] Alvarez-Ayuso E., Garcia-Sanchez A., Querol X., "Purification of metal electroplating waste waters using zeolites," *Water Research*, vol. 37, pp. 4855–4862, 2003.
- [22] Sprynskyy M., Boguslaw B., Terzyk A.P., Namiesnik J., "Study of the selection mechanism of heavy metal ( $Pb^{2+}$ ,  $Cu^{2+}$ ,  $Ni^{2+}$  and  $Cd^{2+}$ ) adsorption on clinoptilolite," *Journal of Colloid and Interface Science*, vol. 304, pp. 21–28, 2006.
- [23] Leinonen H., Letho J., "Purification of metal finishing waste waters with zeolites and activated carbons," *Waste Management and Research*, vol. 19, pp. 45–57, 2001.
- [24] Cincotti A., Mameli A., Locci M.A., Orru R., Cao G., "Heavy metal uptake by Sardinian natural zeolites: Experiment and modelling," *Industrial and Engineering Chemistry Research*, vol. 45, pp. 1074–1084, 2006.
- [25] Deer A., Howie R., Wise W.S., Zussman J., *Rock Forming Minerals* vol. 4B. *Framework Silicates: Silica Minerals, Feldspathoids and the Zeolites*, London: The Geological Society, 2004.

- [26] "Clinoptilolite," 2015. [Online]. Available: <http://www.iza-online.org/natural/Data-sheets/Clinoptilolite/clinoptilolite.htm>.
- [27] Coombs D.S., Alberti A., Armbruster T., Artioli G., Colella C., Galli E., Grice J.D., Liebau F., Mandarino J.A., Minato H., Nickel E.H., Passaglia E., Peacor D.R., Quartieri S., Rinaldi R., Ross M., Sheppard R.A., Tillmanns E., Vezzalini, "Recommended nomenclature for zeolite minerals: Report of the Subcommittee on Zeolites of the International Mineralogical Association, Commission on New Minerals and Mineral Names," *Canadian Mineral*, vol. 35, pp. 1571–1606, 1997.
- [28] "Stilbite," 2015. [Online]. Available: <http://www.iza-online.org/natural/Datasheets/Stilbite/stilbite.htm>.
- [29] "Toxicological profile for lead," U.S. Department of Health and Human Services, Agency for Toxic Substances and Disease Registry, 2007.
- [30] "Toxicology profile for zinc," U.S. Department of Health and Human Services, Agency for Toxic Substances and Disease Registry, 2005.
- [31] Blazev K., Sijakova-Ivanova T., Panov Z., Zajkova-Paneva V., "Preliminary investigations into the mineralogy and potential uses of the stilbite rich tuffs from kratovo-zletovo volcanic area, Republic of Macedonia," *Comptes rendus de l'Academie Bulgare des Sciences*, vol. 65, no. 2, pp. 187–192, 2012.
- [32] Bogdanovic G.D., Antic D.V., Begovic J., Stankovic V., "Adsorption of heavy metals from aqueous solution by natural zeolite," in *Proceedings of the XIV Balkan Mineral Processing Congress*, Tuzla, 2011.
- [33] Nightingale E. R., "Phenomenological theory of ion solvation. Effective radii of hydrated ions," *Journal of Physical Chemistry*, vol. 63, no. 9, pp. 1381–1387, 1959.
- [34] Mobasherpour I., Salahi E., Pazouki M., "Comparative of the removal of  $Pb^{2+}$ ,  $Cd^{2+}$  and  $Ni^{+}$  by nano crystallite hydroxyapatite from aqueous solutions: Adsorption isotherm study," *Arabian Journal of Chemistry*, vol. 5, no. 4, pp. 439–446, 2012.
- [35] Colella C., "Ion exchange equilibria in zeolite minerals," *Mineralium Deposita*, vol. 31, pp. 554–562, 1991.
- [36] Connors K. A., *Chemical Kinetics: The Study of Reaction Rates in Solution*, USA: VCH Publishers, 1990.
- [37] Barrer V. R. M., *Zeolites and Clay Minerals as Sorbents and Molecular Sieves*, London: Academic Press Inc., 1978.
- [38] Low K.S., Lee C.K., Lee K.P., "Sorptions of copper by dye treated oil-palm fibers," *Bioresource Technology*, vol. 44, no. 2, pp. 109–112, 1993.
- [39] Moreno N., Querol X., Ayora C., "Utilization of zeolites synthesised from coal fly ash for the purification of acid mine waters," *Environmental Science and Technology*, vol. 35, pp. 3526–3534, 2001.

- [40] Armenante P. M., "Adsorption," in *Industrial Waste Control: Physical and Chemical Treatment*, New Jersey Institute of Technology.
- [41] Langmuir I., "The adsorption of gases on plane surfaces of glass, mica and platinum," *Journal of American Chemical Society*, vol. 40, pp. 1361–1403, 1918.
- [42] Papageorgiou K. S., Katsaros K.F., Kouvelos P.E., Nolan W.J., LeDeit H., Kanellopoulos K.N., "Heavy metal sorption by calcium alginate beads from *Laminaria digitata*," *Journal of Hazardous Materials*, vol. B137, pp. 1765–1772, 2006.
- [43] Avila M. A. S., *Experiment and Modelling of the Competitive Sorption and Transport of Chlorinated Ethenes in Porous Media*, Gottingen: Cuvillier Verlag, 2005.
- [44] Gunay A., Arslankaya E., Tosun I., "Lead removal from aqueous solution by natural and pretreated clinoptilolite: Adsorption equilibrium and kinetics," *Journal of Hazardous Materials*, vol. 146, pp. 362–371, 2007.
- [45] Çagin V., Use of clinoptilolite for copper and nickel removal from aqueous solutions, The Graduate School of Natural and Applied Sciences of Middle East Technical University, 2006.
- [46] Zendelska A., Golomeova M., Blažev K., Krstev B., Golomeov B., Krstev A., "Kinetic studies of zinc ions removal from aqueous solution by adsorption on natural zeolite," *International Journal of Science, Environment and Technology*, vol. 3, no. 4, pp. 1303–1318, 2014.
- [47] Zendelska A., Golomeova M., Blažev K., Krstev B., Golomeov B., A, Krstev, "Equilibrium studies of zinc ions removal from aqueous solution by adsorption on natural zeolite," *Journal of Materials Science and Engineering A*, vol. 4, no. 7, pp. 202–208, 2014.

