Switched Reluctance Motor Topologies: A Comprehensive Review

Mohammad Mahdi Bouiabady,
Aliakbar Damaki Aliabad and Ebrahim Amiri

Additional information is available at the end of the chapter

<http://dx.doi.org/10.5772/intechopen.69149>

Abstract

Switched reluctance motor (SRM) is gaining much interest in industrial applications such as wind energy systems and electric vehicles due to its simple and rugged construction, high-speed operation ability, insensitivity to high temperature, and its features of fault tolerance. With continued research, different topologies have emerged presenting less torque ripple, high efficiency, high power factor, and high power density. However, there has always been a trade-off between gaining some of the advantageous and losing some with each new technology. In this chapter, various SRM topologies, design, principle of operation, and respective phase switching schemes are extensively reviewed, and their advantages and drawbacks are discussed. On the other hand, some of SRM limitations (such as excitation penalty, control complexity, noise, and vibration) have prompted research into the incorporation of permanent magnets into the basic SRM structure, and therefore, the chapter also includes discussion on a new class of SRM with permanent magnet assist (PM-assist) called doubly salient permanent magnet (DSPMM). The DSPM motor incorporates the merits of both the PM brushless motor and the SRM.

Keywords: comprehensive review, switched reluctance motors, doubly salient permanent magnet, E-core structure

1. Introduction

The original idea of switched reluctance motors (SRMs) dates back to 1814; however, these motors were reinvented and came into practical use in recent decades in line with the development of power electronic devices. Switched reluctance motors have salient poles in both the rotor and the stator and act as a single-excited configuration with inactive (coil-free) rotors. The stator has a centralized winding system with multiple phases. The coils are fed regularly

and sequentially from a DC power supply, and thus, they generate electromagnetic torque. Because of their simplicity and structural strength, SRMs have been of great interest in the past two decades, and they are expected to find broader applications in terms of price and quality compared to other motors. In addition, many studies have been carried out to enhance the performance of these motors as potential alternative to AC (asynchronous and synchronous) motors. At present, switched reluctance motors are in their infancy in commercial terms, but it is expected that they will be used more widely in the near future [1].

SRMs can be considered a stepping motor in type. However, important differences in their configuration and methods used to control them have placed switched reluctance motors into a separate category. The most important differences between SRMs and variable stepper reluctance motors are as follows:

- SRMs have much bigger steps but much fewer poles than steppers.
- SRMs have a closed-loop control system while steppers have specific steps and operate without the use of feedback and in an open loop.

Like other reluctance motors, SRMs usually have no magnets in the rotor and stator, and thus, they enjoy a simple, cheap, and firm structure. However, a small amount of permanent magnetic materials is used in some types of these motors to improve their torque. The number of the ratio of stator poles to rotor poles used in SRMs is rather limited, the most common of which are 4:6 and 6:8, each with its own possible multipliers. It should be noted that each pair of coils facing each other makes up a phase. Therefore, for 4:6 and 6:8 ratios, there will be three phases and four phases on the stator, respectively. **Figure 1** depicts a three-phase and four-phase SRM [2, 3].

In two-phase structures, the problem of nongeneration of the starting torque is solved by the stepping or asymmetric nature of the aerial gap, but the problem of the high-torque ripple remains unsolved. Generally, two-phase structures best suit high-speed applications and the structures for which the drive and coil cost is an issue. The three-phase structure is one of the most widely used structures, and the four-phase structure is used to reduce torque ripple [1, 2].

Depending on their applications, SRMs are produced within a wide range of structures. **Figure 2** presents a classification of these motors based on their movement patterns, flux path, and type of excitation, each being examined in the following sections.

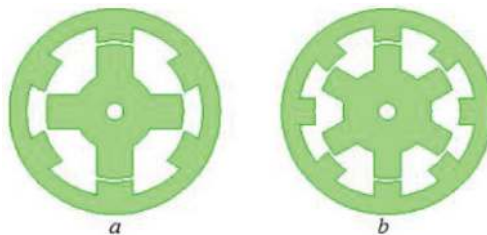

Figure 1. (a) A three-phase and (b) a four-phase SRM configuration.

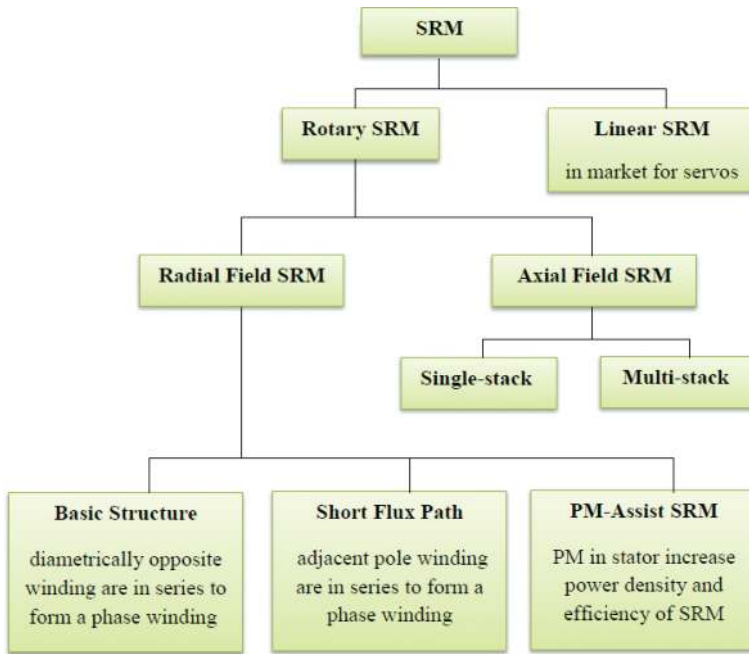

Figure 2. SRM classification based on movement pattern, flux path, and type of excitation.

2. Structural and operational concept of switched reluctance motor

SRMs have a laminated rotor and stator with $N_s = 2 \times m \times q$ poles in the stator and N_r poles in the rotor (m stands for the number of phases and $q=1, 2, 3, \dots$). Each phase has a centralized coil on the stator poles. The 6:4 three-phase and 8:6 four-phase structures are among the most common SRM structures (with the first number representing the number of the stator poles and the second number showing the number of the rotor poles), as shown in **Figure 3(a)** and **(b)**.

These two configurations have a constant ($q=1$), showing that two centralized coils are placed on a pair of poles in each stator phase. Of course, q can be equal to 2 or 3 too, as in 8:12 or 12:18 three-phase configurations which are used in both high-speed, high-torque motors and high-speed generator systems. In addition, to avoid forming zero-torque areas, the same angles ($\beta_s = \beta_r$) are preferably chosen for the stator and rotor poles [4].

Because of the symmetry of the SRM magnetic circuit, the phase flux linkage is zero even under saturation conditions. Therefore, if a motor phase is short-circuited, the motor is still able to operate with $m - 1$ phases. In this case, due to the lack of mutual induction, no voltage or current is generated in the short-circuited phase. As a result, SRMs are more resistant to faults than other AC motors that operate based on the phase interaction. Besides, self-inductance plays a key role

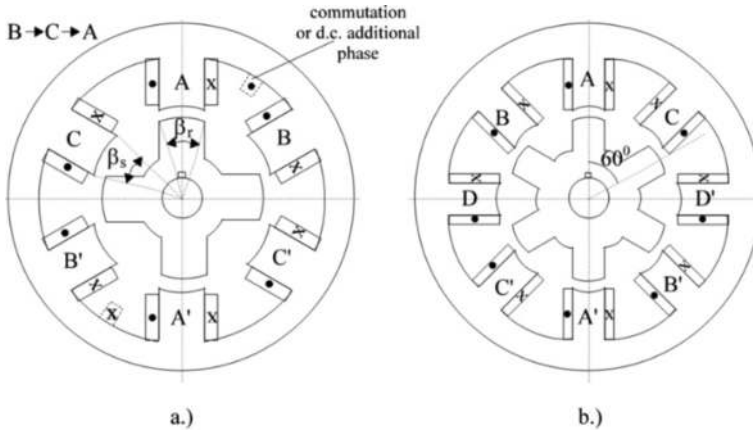

Figure 3. 6:4 three-phase and 8:6 four-phase configurations.

in producing torque in SRMs. In the absence of saturation, self-inductance for each phase changes linearly based on the rotor position, while as the core is saturated, self-inductance changes in a nonlinear fashion, as illustrated in **Figure 4**.

If flux λ is calculated in different rotor positions and is plotted in terms of the current, a class of $\lambda(\theta_r, i)$ curves will be obtained as shown in **Figure 5**. The saturation effect is clearly evident in this figure. Saturation can also be observed even in well-designed motors [4].

If the $W_{mc}(\theta_r)$ co-energy is known, the moment torque of $T_e(i)$ phase can be calculated through Eq. (1):

$$T_e(i) = \left(\frac{\partial W_{mc}(\theta_r)}{\partial \theta_r} \right)_{i=\text{cons.}} ; W_{mc} = \int_i^0 \lambda(\theta_r, i) di \quad (1)$$

To calculate Eq. (1), the class of $\lambda(\theta_r, i)$ curves needs to be calculated via Eq. (2) as follows:

$$T_e = \sum_{i=1}^m T_e(i) \quad (2)$$

The moment torque can be measured through Eq. (3) in cases when there is no saturation:

$$T_e = \sum_{i=1}^m \frac{1}{2} i_i^2 \frac{\partial \lambda_i(\theta_r)}{\partial \theta_r} \quad (3)$$

Ideally, when the rotor poles are placed between the two poles of the stator, the phase is excited in the same direction to create motoring function. This is shown in **Figure 6** where the voltage pulse is only applied for conduction angle $\theta_\omega = \theta_c + \theta$.

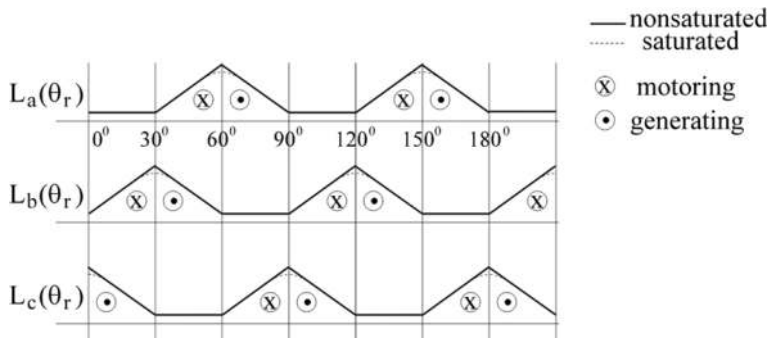

Figure 4. Phase inductance and operation modes in a 4:6 SRM.

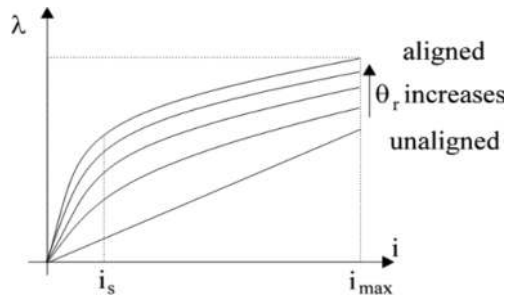

Figure 5. $\lambda(\theta_r, i)$ curves.

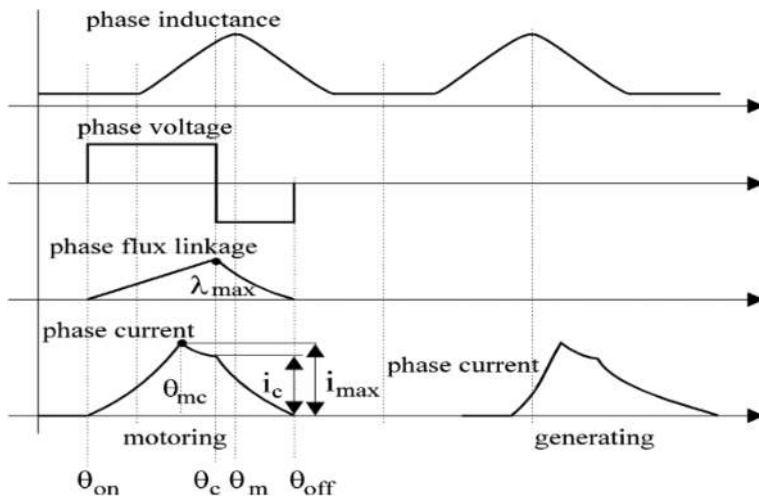

Figure 6. Phase inductance, phase voltage, phase flux linkage and phase current.

Excluding the ohmic voltage drop and taking the speed ω_r as constant, the maximum phase flux linkage (λ_{\max}) is calculated as follows:

$$\lambda_{\max} = \int_0^t V_d dt = V_d \frac{\theta_\omega}{\omega_r} \quad (4)$$

The maximum θ_ω for $\theta = 0$ (the zero-pre-phase angle) is determined based on the design using Eq. (5):

$$\theta_{\omega \max} = \theta_m = \frac{\pi}{N_r} \quad (5)$$

The base speed corresponds with $\theta_{\omega \max}$ conditions, single pulse voltage applied with amplitude V_d , and the maximum phase flux linkage. Therefore, it can be suggested that the base speed is dependent on the motor design and the saturation level. As the speed outpaces the base speed, the motor magnetic circuit is saturated.

For speeds higher than the base speed ($\omega_r > \omega_b$) θ_ω should decrease slightly, and subsequently, the maximum phase flux linkage (λ_{\max}) should be reduced to a certain amount, a phenomenon known as flux attenuation. In addition, in speeds above the nominal speed, in order to achieve the maximum phase flux linkage (λ_{\max}) at a smaller θ_c angle and the maximum phase flux linkage (λ_{\max}) at a smaller θ_c angle, and ultimately to generate more torque, the phase firing angle (θ_{on}) should be leading compared to normal conditions. Therefore, the envelope of the torque-speed curve increases accordingly. On the other hand, the phase deactivating process starts at $\theta_c \leq \theta_m$ and ends in the generating zone at θ_{off} . A decrease in $\theta_{\text{off}} - \theta_m$ angle will reduce the share of negative torque in the deactivating process. In practice, if at $\theta_r = \theta_m$ the current value is less than 25–30%, the effect of negative torque will be insignificant [4].

When a phase is cut at an angle θ_c , the other phase turns on and thus the total rate of the torque caused by the interruption of the current in the previous phase is reduced through generating a positive torque.

It is now clear that the magnetic energy of each phase at the conduction time first increases and then decreases. This phenomenon is repeated in each mechanical round for $m \times N_r$ times. At each stage, a part of the magnetic energy is wasted by electronic power converters, and the rest is returned to the DC link and the capacitor of the converter filter. Below the base speed ω_b , current is controlled and restricted by pulse with modulation (PWM) converter as shown in **Figure 7**.

It should be reminded that the conduction time lasts near the angle θ_m , at which the inductance phase angle is maximum. As it was mentioned earlier, the firing phase angle at high speeds is θ_{on} and the turn off angle is θ_c leading.

2.1. The average torque and the energy conversion rate

Magnetic energy conversion levels in both cases of the single voltage pulse (**Figure 6**) and the PWM current and voltage (**Figure 7**) are shown on $\lambda(\theta_r, i)$ curves in **Figure 8(a)** and **(b)**, respectively [4].

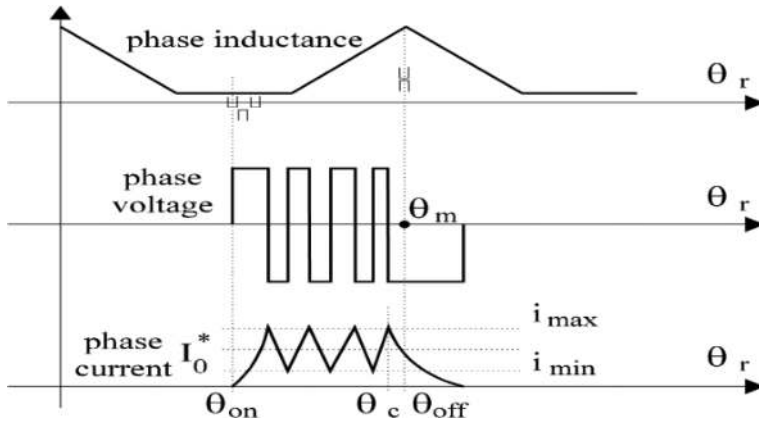

Figure 7. Current and voltage control in a phase below the base speed using PWM converter.

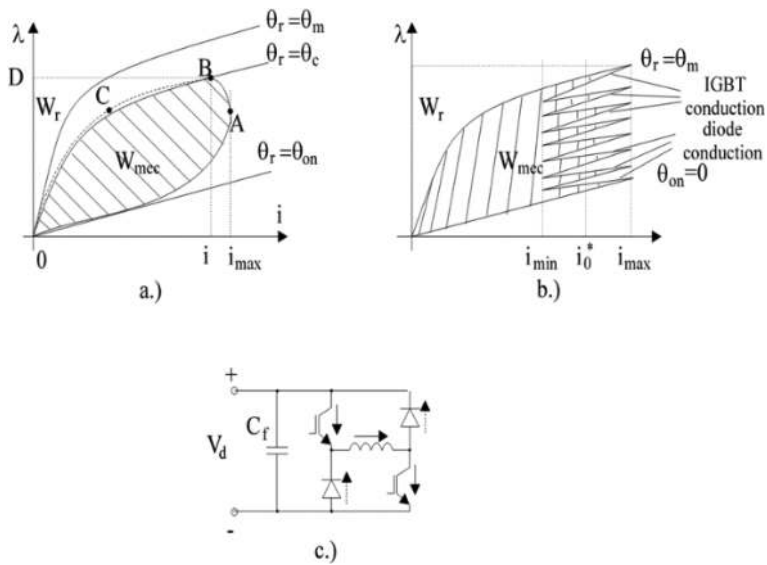

Figure 8. Energy exchange in each phase: (a) at high speeds (single pulse voltage); (b) at low speeds (PWM current and voltage); (c) the converter single-phase feeding configuration to generate a unidirectional current in each phase.

In addition, the converter configuration for feeding a motor phase is shown in **Figure 8(c)**. The average torque (T_{ave}) is proportional to the shaded areas (W_{mec}) in **Figure 9(a)** and **(b)**. Thus, the m -phase SRM average torque and the number of N_r rotor poles at a constant speed can be calculated through Eq. (6):

$$T_{ave} = \frac{W_{mec}mN_r}{\theta_c - \theta_{on}} \tag{6}$$

It should be noted only one phase of SRM conducts at each moment.

2.2. SRM generator function

SRM generator function is slightly more complicated. General principles and strategies for SRM generating mode are described in Ref. [5]. The motor and converters used in this method are shown in Figure 9.

To evaluate the generating mode, it is assumed that the generator rotor is rotated anticlockwise by an external torque. In this situation, consider a time when poles 1,1' are facing poles A₁, A₃ and poles 3,3' are facing poles A₂, A₄ and the switches S₁, S₂ are closed. In this case, the inductance is at the maximum level and a magnetic flux is generated by the battery in the core. When this happens, the external mechanical torque rotates the rotor and pulls the poles apart, and thus, the inductance is increased. According to minimum reluctance theory, the motor tends to maintain the minimum reluctance, and thus, a torque is generated in the opposite direction of the mechanical torque; thus, the mechanical energy is stored as the magnetic energy in the stator winding. When the rotor reaches a certain angle, switches S₁, S₂ are opened and the current flows through freewheeling diodes into the battery and is stored there [5–7].

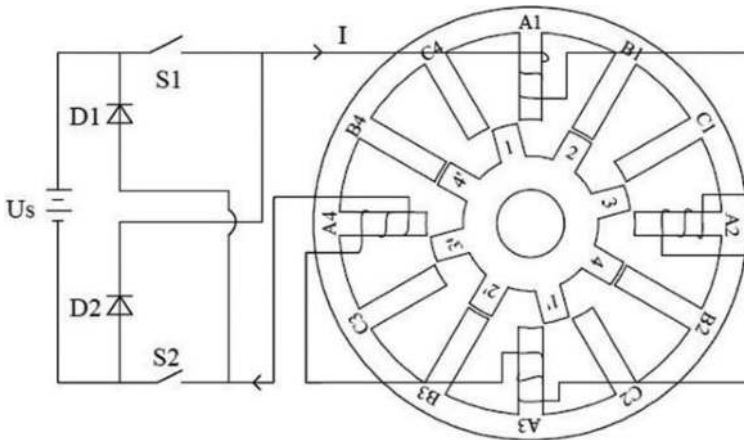

Figure 9. A 12:8 pole three-phase SRM generator configuration.

3. SRM equivalent circuit

Due to the extreme effects of high saturation on $\lambda(\theta_r, i)$ class curves, the mathematical model of the motor is highly nonlinear. However, as the interoperability among phases is insignificant,

the cumulative effects of phases torque can be used to calculate the motor torque. An SRM has two saliencies in its structure, so we have to use the motor equations in the stator phase frame [4]. The voltage equation is expressed as follows:

$$V_{a,b,c,d} = r_s i_{a,b,c,d} + \frac{d\lambda_{a,b,c,d}(\theta_r, i_{a,b,c,d})}{dt} \quad (7)$$

where $\lambda_{a,b,c,d}(\theta_r, i_{a,b,c,d})$ curves are obtained using curves for a phase periodically with the π/N_s alternation. These curves can be obtained through calculation or experiments. For this purpose, finite element method or analytical techniques can be used. In addition, considering the effects of magnetic saturation and air gap flux distribution is required in all of these techniques. The motion equation is stated as follows:

$$J \frac{d\omega_r}{dt} = T_e - T_{load}; \quad \frac{d\theta_r}{dt} = \omega_r \quad (8)$$

where

$$T_e = \sum_{a,b,c,d} T_{e_{a,b,c,d}}; \quad \frac{\partial}{\partial \theta_r} \int_0^{i_{a,b,c,d}} \lambda_{a,b,c,d}(\theta_r, i_{a,b,c,d}) di_{a,b,c,d} \quad (9)$$

If the subscript i use to refer to the active phase, then Eq. (7) can be rewritten as follows:

$$V_i = r_s i_i + \frac{\partial \lambda_i di_i}{\partial i_i dt} + \frac{\partial \lambda_i d\theta_r}{\partial \theta_r dt} \quad (10)$$

The $\frac{\partial \lambda_i}{\partial i_i}$ term shows the transient inductance (L_t). Thus, we have:

$$L_t(\theta_r, i_i) = \frac{\partial \lambda_i(\theta_r, i_i)}{\partial i_i} \quad (11)$$

The last term in Eq. (10) shows the motoring induction voltage (E):

$$E_i = \frac{\partial \lambda_i}{\partial \theta_r} \omega_r \quad (12)$$

Accordingly, Eq. (10) is rewritten as follows:

$$V_i = r_s i_i + L_t(\theta_r, i_i) \frac{di_i}{dt} + E_i(\omega_r, \theta_r, i_i) \quad (13)$$

Based on this equation, an equivalent circuit with time-dependent parameters can be introduced for SRMs as shown in **Figure 10**.

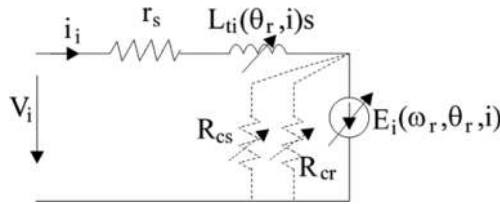

Figure 10. SRM equivalent circuit based on the core loss.

Assuming that the core loss is only due to the main flux component, the core loss can be modeled by variable resistors parallel with the E_i . This motor does not operate based on a rotating field and the core loss occurs in both the rotor and the stator [4].

Taking into account, the energy loss especially at high speeds is required not only to calculate the efficiency but also to evaluate and calculate the transient current response. The operating time of SRMs is generally very high in saturation conditions. In addition, $E(\omega_r, \theta_r, I_i)$ in Eq. (12) is a pseudo emf that contains the terms related to the stored energy. So in this case, the torque should be calculated only through the co-energy equation.

4. SRM categories

As shown in Figure 3, SRMs can be categorized into different groups based on their movement patterns and flux paths. This section presents a categorization of SRMs.

4.1. Linear-switched reluctance motors

Linear-switched reluctance motors (LSRMs) are similar to conventional SRMs in their structure except that their rotor and stator are cut open taking a linear form (Figure 11). One of the applications of these motors is in electric trains and subways.

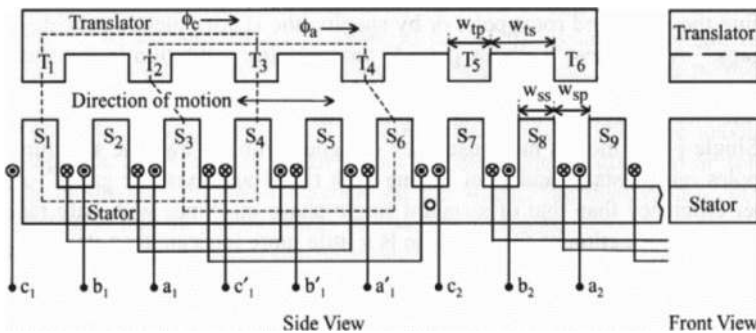

Figure 11. LSRM structure.

4.2. Axial-flux switched reluctance motors

In these motors, the flux path is aligned with the motor axis, and they are used for cases where the motor length is of high importance and the motors with a small length and high torque are preferred for applications such as air conditioning fans and electric vehicles. **Figure 12** displays the configuration of an axial-flux switched reluctance motor.

4.3. Radial-flux switched reluctance motors

Radial-flux switched reluctance motors are the most common structure among SRM structures, and they are divided into two categories:

- Conventional switched reluctance motors: in this structure, the facing poles are connected in series to form a phase.
- Short-path switched reluctance motors: in this structure, the adjacent poles are connected in series to form a phase.

The conventional SRMs are introduced in the first section of this chapter. Other configurations are discussed in the following sections.

4.3.1. Short-flux path SRM

In the short-flux path SRM, the returned flux does not pass through the entire stator yoke, and thus, flux path is shortened, reducing the core loss. **Figure 13** shows a short-flux path SRM. The most common problems with this configuration are the high mutual inductance and the imposition of asymmetric magnetic fractions.

Another type of motors with a short-flux path is the common pole E-core SRM as shown in **Figure 14**. As it can be seen in this figure, this motor has three poles on the stator in which the middle pole lacks winding. In fact, this structure has two phases on the stator, and the middle pole is the shared pole between the two phases and its task is to create a path for the passage of flux. In addition, the shared pole does not play a role in reluctance changing due to its width [8, 9].

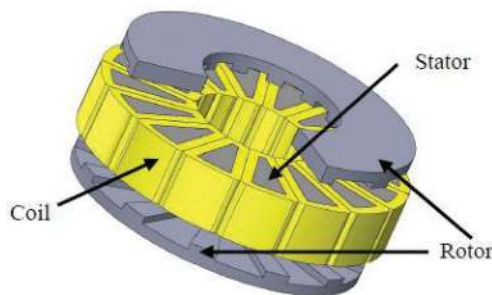

Figure 12. Axial-flux SRM structure.

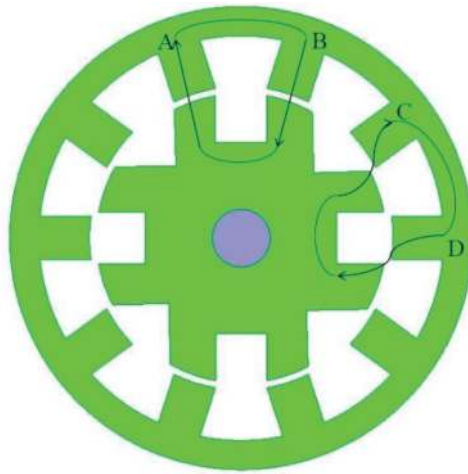

Figure 13. A short-flux path MRS configuration.

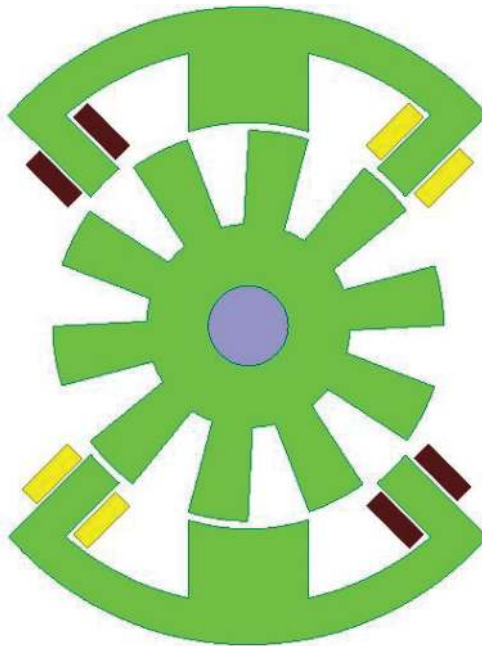

Figure 14. A common pole E-core SRM configuration.

Figure 15 displays the functioning and flux path in a common pole E-core SRM. As it is shown, this structure has a short-flux path. To make this type of structure enable to generate torque, at least an E-core must be used in the stator so that it can rotate the rotor. However, two E-cores

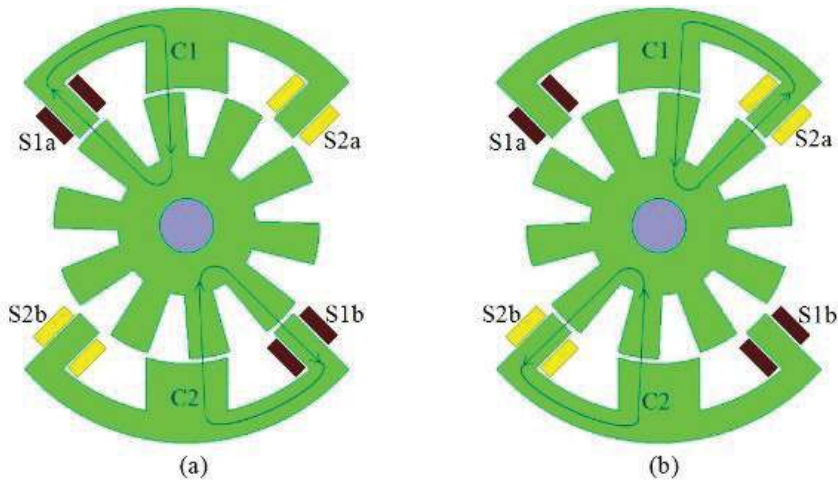

Figure 15. Flux path in a common pole E-core SRM when energizing (a) phase 1; (b) phase 2.

are usually used in the stator because when a single E-core is used it applies an asymmetric axial force to the rotor axis and the motor does not function properly. Therefore, a two E-core stator is employed, as shown in **Figure 15**. Increasing the number of E-shaped parts in the stator increases the torque and power produced by the motor [10–12].

However, a stator with separate parts is not commonly used in common pole E-core SRMs as putting together these parts and preventing their vibration and displacement are a difficult task. Besides, any structural changes may lead to asymmetrical operation. Therefore, the stator of these motors is usually constructed based on integrated 4-E-core motors. **Figure 16** shows a 4-E-core SRM:

4.4. PM-assisted SRM

Because of their own advantages, SRMs have attracted the attention of many industries in recent years. However, these motors suffer from some drawbacks and common problems such as low power and torque density, the complexity of control methods, acoustic noises, and losses related to current excitation. For this reason, some efforts have been made in recent years to use permanent magnetic materials in SRMs. This has led to the emergence of a new configuration called doubly salient permanent magnet motor (DSPMM), which shares the same configuration and functionality of conventional switched reluctance motors and at the same time contains permanent magnet materials in the stator. In many studies, DSPMMs have been considered as a subset of permanent magnet motors. However, as they share the same configuration in the rotor and stator and functionality with SRMs, they have been studied under the category of permanent magnet (PM)-assisted SRMs. This section will examine some of the PM-assisted SRMs, their operating principles, and some of their advantages and disadvantages listed in the literature [2, 13, 14].

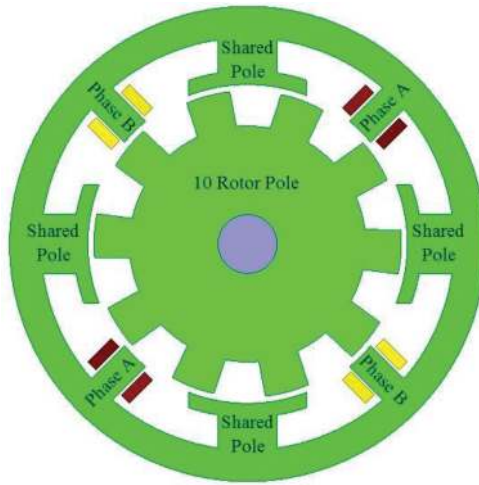

Figure 16. A common pole E-core SRM configuration.

Some of the most important configurations that have been introduced in the literature are as follows:

- Unidirectional flux PM-assisted motors
- Flux-switching motors
- Flux reversal motors
- Hybrid-excited motors

4.4.1. Unidirectional flux PM-assisted motors

This is a common configuration among doubly salient permanent magnet motors (DSPMMs). Even though the rotor and stator are salient poles, the magnetic torque overcomes the reluctance torque, and thus, the generated cogging torque is not considerable. Since with the rotation of the rotor, the linkage flux in each of the coils changes only in one direction, the biggest problem with these motors is the low-torque density caused by the unidirectional flux linkage in each of the coils. **Figure 17** shows two versions of this type of motor [15].

The only advantage of the configuration shown in part (b) compared to the configuration in part (a) is that the former contains more magnetic materials and thus its flux density will be greater. The configuration shown in part (b) is called the yoke linear magnet, and the configuration in part (a) is called the yoke curved magnet [15].

4.4.2. Flux-switching motors

In this configuration, each stator tooth is made of a magnet and two adjacent layers of magnetic core. As shown in **Figure 18**, the stator structure consists of separate U-shaped parts which are

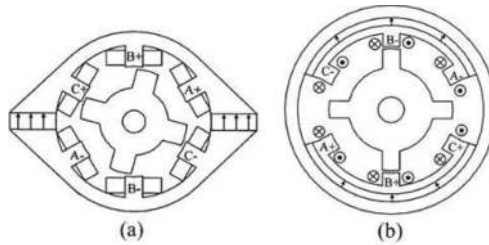

Figure 17. Two unidirectional flux PM-assisted motors.

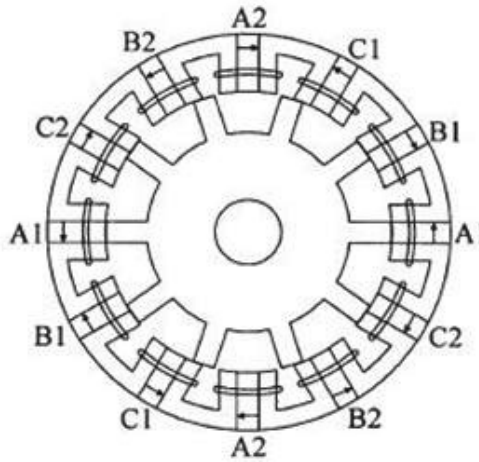

Figure 18. A flux-switching motor.

sandwiched by two adjacent magnets. **Figure 18** shows a constituent cell of this type of motors. A complete motor is formed by putting together a given number of these cells [15, 16].

As shown in **Figure 19(a)**, the flux generated by the magnet is aligned with the flux produced by the coils, and thus, they reinforce each other and, consequently, a great torque is generated. As the rotor rotates to the right, the rotor teeth are moved and the motor is in position (b). In this position, with switching the direction of current in the coil, the fluxes generated by the magnet and the coil are aligned again and they reinforce each other. Therefore, as the direction of the current is switched alternately in the coils, a stable torque will be produced for rotation of the rotor. **Figure 20** displays several other configurations for flux-switching motors [15–18].

4.4.3. Flux reversal motors

These motors have a structure that is similar to SRMs with the difference that there is a magnet with different polarity on each pole. Besides, the flux within each coil can be bi-directional in these motors. Since the linkage flux is steadily reversed as the rotor rotates, these motors are called flux reversal permanent magnet motors. In this structure, each stator tooth has a dipole

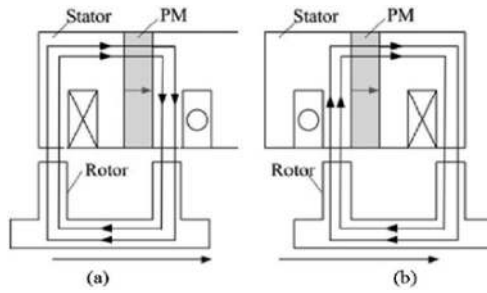

Figure 19. Operational principle of a flux-switching motor.

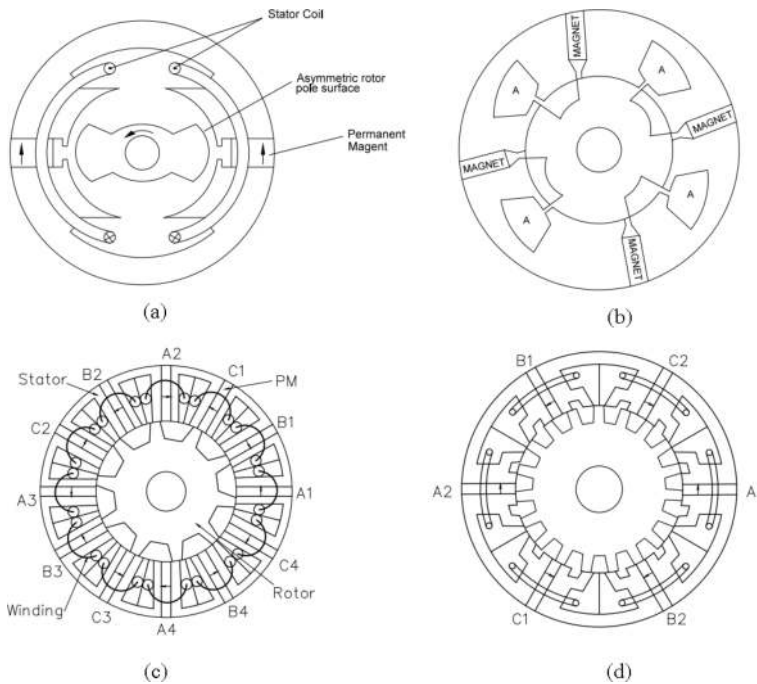

Figure 20. Additional configurations for flux-switching motors. (a) Basic concept (b) Practical one-phase concept (c) Three phase concept (d) Multi-tooth three phase concept.

magnet which is placed on the tooth surface. These motors generate a greater torque because of bi-directional linkage flux of each coil. However, it should be noted that as permanent magnets are placed on the surface of tooth, they are more vulnerable to mechanical damages and may lose their magnetic properties. In addition, there are a significant amount of eddy current losses in the permanent magnet materials. **Figure 21** shows an example of this structure [13]. To explain the principle of operation, a simple single-phase structure of such a motor is illustrated in **Figure 22**.



Figure 21. A flux reversal motor.

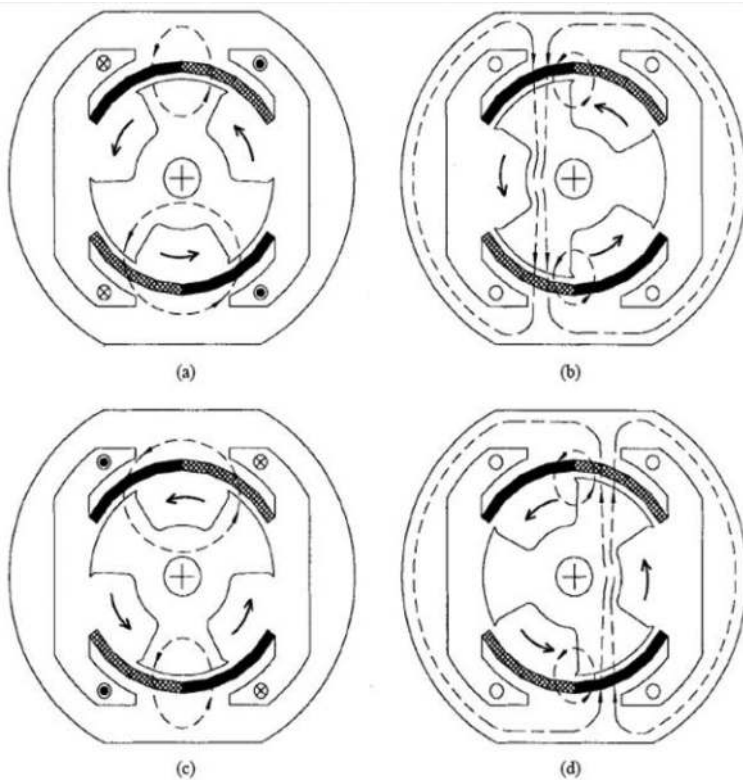

Figure 22. The functioning of flux reversal motors.

Position (a) in this figure is a state of equilibrium in which the rotor remains fixed until the stator windings are excited in the direction of current shown in position (a). The excitation current strengthens the flux of one magnet while attenuates the flux of another magnet which places the rotor in position (b). At this moment, the stator current is disconnected and the rotor moves to the next equilibrium state in position (c). As the current is connected in an opposite direction to position (a), the rotor position is placed in position (d) through the generated flux. The nonstop repetition of these steps will produce torque in the motor. It should be noted that the linkage flux in positions (a) and (c) is at the lowest levels, while it is at the highest level in both positions (b) and position (d) in the positive and negative direction, respectively, as shown in **Figure 22** [13, 15, 19].

4.4.4. Hybrid-excited DSPM motors

In this type of motors, the permanent magnet excitation is combined with electrical excitation in the coils and creates an electric field. Hybrid-excited field provides attractive features to these motors and makes them a perfect choice for use in systems such as wind turbines and electric vehicles. Some of these features include:

- The possibility of controlling the air gap flux by changing the polarity and size of the DC current in the excitation coil.
- By strengthening the field, the motor will be able to produce an extremely high torque when necessary.
- By attenuating the field, the constant power zone of the motor is extended and creates a wide speed range.
- By the appropriate adjustment of the air gap flux density, it will be possible to produce a constant output voltage for the generating mode of the motor while the speed of the generator may undergo many changes.
- By the appropriate adjustment of the air gap flux density, it will be possible to create efficiency optimization control (EOC) which in turn makes it possible to optimize the efficiency of the motor during operation. This feature is very prominent because the efficiency of the motor is maintained at an acceptable level at all possible speeds.

Figure 23 shows the structure of a hybrid-excited motor. The structure of the rotor and stator poles in this motor is exactly similar to that of a conventional SRM. However, there are some permanent magnet materials and two coils with DC excitation current in the stator. By changing the DC current in the coils, it is possible to control the excitation flux. This makes it possible to control the motor through simple techniques. This structure is called stator doubly fed doubly salient configuration. Because of the existence of DC excitation coils on the stator, these motors produce a high flux leakage, which is regarded as a serious drawback for these motors [20–22].

4.5. Common pole PM-assist SRM

Ref. [23] introduces a common pole PM-assist SRM, which has a permanent magnet in the excitation pole. **Figure 24** shows the flux path in these motors when energizing phases. As it can be seen in this figure, the flux path is designed in a way that, during energizing each phase,

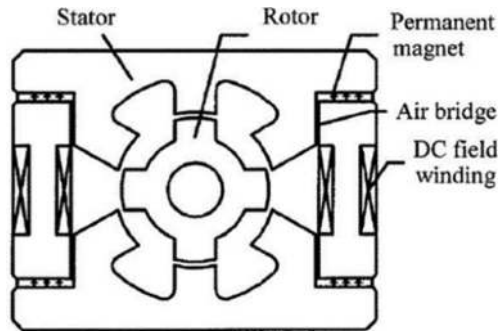

Figure 23. A hybrid-excited DSPM motor.

the fluxes generated by the coil and magnet are aligned with and reinforce each other. One advantage of this structure is that because of the presence of common poles between phases, the flux path does not allow the reverse flux to pass through the permanent magnet, and therefore, there is no risk of losing the magnetic flux of magnets in this structure. In this structure, two magnet blades are placed in excitation poles as shown in **Figure 24**.

One of the effective parameters in increasing the torque produced by the motor is the distance between the two magnet blades. As the distance between the blades increases, the generated torque will also increase. Therefore, the wider the poles, the greater the generated torque will be. Another parameter affecting the torque is the width of the blades as studied in Ref. [23].

Another similar structure is introduced in Ref. [24], with the only difference the blades of the permanent magnet are in the common poles, as shown in **Figure 25**. Given the greater width of the common poles in this structure, the use of magnet blades in these poles is more practical and provides further improvement in the motor performance. These two structures have been studied from different perspectives in Ref. [25]. Generally, it can be concluded that these two structures have a superior performance over the structure that lacks magnet.

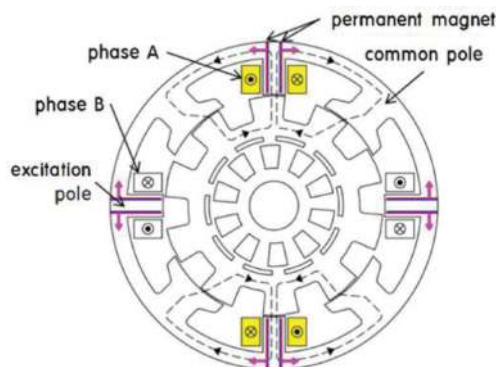

Figure 24. The flux path in a PM-assisted SRM.

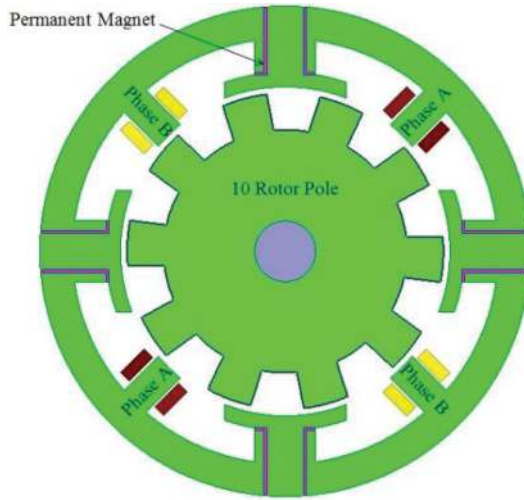

Figure 25. A PM-assisted SRM with a permanent magnet in common poles.

Ref. [8] introduces another configuration of PM-assisted SRMs in which the magnet is placed on the outer surface of the common poles, illustrated in Figure 26. The biggest advantage of the structure shown in Figure 26 is the integrity of the stator compared to the previous structure, which improves the motor strength and performance. But this structure also has a big problem that is related to the location of magnets. If the thickness of the magnet is increased to enhance the flux density, the torque will not increase. This is because as the air gap in the common poles increases, the motor reluctance also increases which decreases the reluctance torque. Therefore, it is possible to use small amounts of permanent magnet materials in this structure.

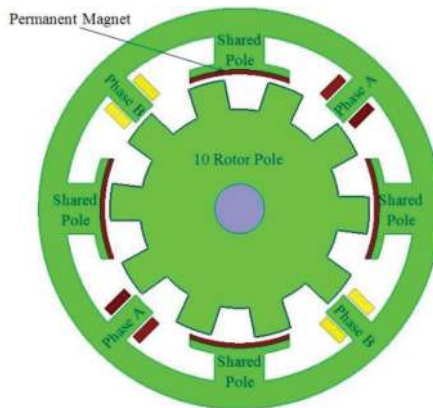

Figure 26. A PM-assisted SRM with a permanent magnet on the surface of common poles.

4.6. Single-phase SRM

Because of their simple structure and low production and maintenance cost, single-phase switched reluctance motors are very appropriate for high-speed applications. When the rotor and stator poles are aligned, the excitation of the stator and rotor poles is interrupted and the rotor continues to move because of the kinetic energy stored in it. When the rotor and stator poles are not aligned, the excitation of the stator windings is resumed and it applies an electromagnetic torque to the rotor. The main problem with this structure is that if the rotor at starting point is in a position where the poles are aligned, the starting torque is not generated and the motor is not able to move. This problem makes these motors inefficient, and they are not used in practice. **Figure 27** shows a very simple single-phase SRM in which the problem of the lack of torque in alignment position is almost solved by placing a permanent magnet on the stator in order to prevent the alignment of the poles in the static mode [4]. These motors have a high-torque ripple and acoustic noise. Thus, they are suitable for use in equipment and tools that are not very sensitive to torque ripple such as home appliances.

Single-phase SRMs have an equal number of poles in the rotor and the stator (2:2 or 4:4). The possibility of a pause in the self-starting position has led to their widespread use in home applications and vehicle parts with a torque less than 1 Nm.

4.7. Double stator-switched reluctance motor (DSSRM)

A qualitative investigation of tangential and normal force densities in electromechanical energy conversion process and the energy conversion process within SRM were presented in [26, 27]. A review of the literature indicates that the majority of the electromagnetic forces that are generated within a conventional SRM are in the radial/normal direction (perpendicular to the direction of motion) and do not contribute to the motion. In fact, a significant part of these forces will initiate undesirable vibrations that have been identified as a major drawback for SRM drives.

It is desirable to generate a larger percentage of the electromagnetic forces that are effectively acting in the direction of motion. Based on these guidelines, double stator-switched reluctance

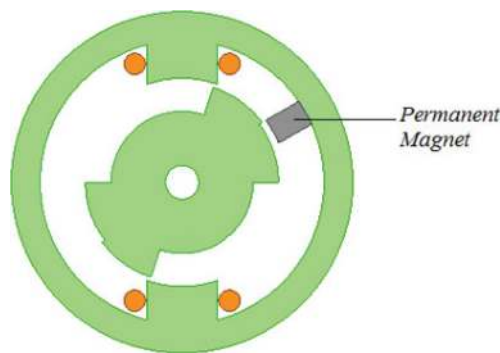

Figure 27. A single-phase SRM with a permanent magnet to prevent the alignment of poles in static mode.

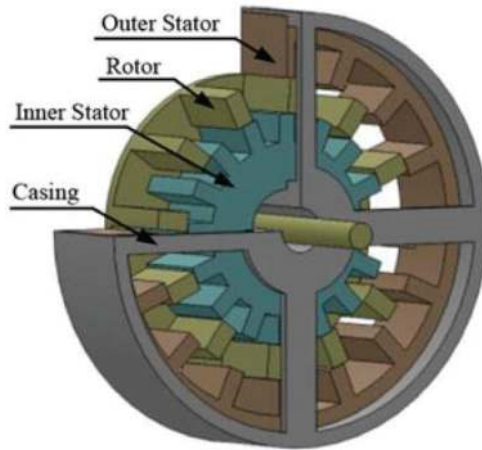

Figure 28. Primary 3-D model of designed DSSCR-SRM.

motor (DSSRM) was proposed in Refs. [28, 29]. **Figure 28** shows the design of a DSSRM proposed in Ref. [29].

5. Conclusion

This chapter presented a comprehensive technology status review highlighting structural and operational concept of SRM, its equivalent circuit model, advantages and drawbacks of each topology as well as recent trends in incorporating PMs in the motor design to boost the overall performance of the motor. The chapter also covers a new class of SRM with double stator geometry. Unlike conventional design in which majority of the electromagnetic force is applied in radial/normal direction (hence not contributing to the motion), double stator design offers a much more efficient configuration in terms of generation of motional forces and exhibits superior performance indexes as compared to conventional design and as such is viewed as a serious contender for high-grade industrial applications.

Author details

Mohammad Mahdi Bouiabady¹, Aliakbar Damaki Aliabad¹ and Ebrahim Amiri^{2*}

*Address all correspondence to: eamiri@uno.edu

1 Yazd University, Yazd, Iran

2 University of New Orleans, New Orleans, LA, USA

References

- [1] Krishnan R. *Switched Reluctance Motor Drives: Modeling, Simulation, Analysis, Design, and Applications*. CRC Press, Taylor & Francis Group, Boca Raton, Florida, 2001
- [2] Miller TJE. *Switched Reluctance Motors and Their Control*. Oxford, U.K.: Magna Physics Publishing/Oxford Science; 1993
- [3] Rajashekara K. Present status and future trends in electric vehicle propulsion technologies. *IEEE Journal of Emerging and Selected Topics in Power Electronics*. 2013;**1**(1):3–10
- [4] Nasar SA, Boldea I. *Electric Drives*. Electric Power Engineering Series. 2nd ed. Boca Raton: CRC Press; 2005
- [5] GuojunY, et al. Research on the control strategy of switched reluctance generator system. In: *Proceedings of the IEEE International in Electronics and Application Conference and Exposition (PEAC)*; 2014
- [6] Bao YJ, Cheng KWE. Experimental examination on a new switched reluctance wind power generator system for electric vehicles. *IET Power Electronics*. 2012;**5**:1262–1269
- [7] Narla S, Sozer Y. Switched reluctance generator controls for optimal power generation and battery charging. *IEEE Transactions on Industry Applications*. 2012;**48**:1452–1459
- [8] Lobo NS. *Doubly-salient permanent magnet flux-reversal-free-stator switched reluctance machines*. PhD diss, Virginia Polytechnic, Blacksburg, Virginia, 2011.
- [9] Lee C, Krishnan R, Lobo N. Novel two-phase switched reluctance machine using commonpole E-core structure: Concept, analysis, and experimental verification. *IEEE Transactions on Industry Applications*. 2009;**45**(2):703–711
- [10] Krishnan R, Lobo NS. Apparatus and method that prevent flux reversal in the stator back material of a two-phase SRM. U.S. Patent 7 015 615, March 21, 2006
- [11] Oh SG, Krishnan R. Two phase SRM with flux reversal free stator: Concept, analysis, design and experimental verification. In: *Proceedings of the Conference Record of the IEEE IAS Annual Meeting*, Vol. 3; 2006. pp. 1155–1162.
- [12] Eskandari H, Mirsalim M. An improved 9/12 two-phase e-core switched reluctance machine. *IEEE Transactions on Energy Conversion*. 2013;**28**(4):951–958
- [13] Deodhar RP, et al. The flux-reversal machine: A new brushless doubly-salient permanent-magnet machine. *IEEE Transactions on Industry Applications*. 1997;**33**(4):925–934
- [14] Liao Y, Liang F, Lipo TA. A novel permanent-magnet motor with doubly-salient structure. *IEEE Transactions on Industry Applications*. 1995;**31**:1069–1078
- [15] Chau K, Chan C, Liu C. Overview of permanent-magnet brushless drives for electric and hybrid electric vehicles. *IEEE Transactions on Industrial Electronics*. 2008;**55**(6):2246–2257
- [16] Cheng M, Chau KT, Chan CC. Design and analysis of a new doubly salient permanent magnet motor. *IEEE Transactions on Magnetics*. 2001;**37**(4):3012–3020

- [17] Hoang E, Ben Ahmed A, Lucidarme J. Switching flux permanent magnet poly-phased synchronous machines. In: European Conference on Power Electronics and Applications; 1997
- [18] Zulu A, Flux switching machines using segmental rotors. PhD Thesis. Newcastle University, Newcastle upon Tyne, Tyne and Wear, UK, 2010
- [19] Deodhar RP, Andersson S, Boldea I, Miller TJE. The flux-reversal machine: A new brushless doubly-salient permanent magnet machine. *IEEE Transactions on Industry Applications*. 1997;**33**(4):925–934
- [20] Chau K, et al. Design and control of a PM brushless hybrid generator for wind power application. *IEEE Transactions on Magnetics*. 2006;**42**(10):3497–3499
- [21] Fan Y, Chau KT, Cheng M. A new three-phase doubly salient permanent magnet machine for wind power generation. *IEEE Transactions on Industry Applications*. 2006;**42**(1):53–60
- [22] Chau KT, Jiang JZ, Wang Y. A novel stator doubly fed doubly salient permanent magnet brushless machine. *IEEE Transactions on Magnetics*. 2003;**39**(5):3001–3003
- [23] Hwang H, Hur J, Lee C. Novel permanent-magnet-assisted switched reluctance motor (I): Concept, design, and analysis. In: Proceedings of the 2013 International Conference on Electrical Machines and Systems (ICEMS); 2013
- [24] Jeong J, Her J, Lee C. Novel permanent-magnet-assisted switched reluctance motor (II): Concept, design, and analysis. In: Proceedings of the 2013 International Conference on Electrical Machines and Systems (ICEMS); 2013
- [25] bookCho J, Hur J, Lee C. Control scheme of a novel permanent-magnet-assisted switched reluctance machine. In: Proceedings of the 2013 International Conference on Electrical Machines and Systems (ICEMS); 2013
- [26] Jiang W, Moallem M, Fahimi B, Pekarek S. Qualitative investigation of force density components in electromechanical energy conversion process. In: Proceedings of the 32nd Annual Conference on IEEE Industrial Electronics (IECON); November; 2006. pp. 1113–1118
- [27] Edrington CS, Kaluvagunta DC, Joddar J, Fahimi B. Investigation of electromagnetic force components in SRM under single and multiphase excitation. *IEEE Transactions on Industry Applications*. 2005;**41**(4):978–988
- [28] Abbasian M, Moallem M, Fahimi B. Double-stator switched reluctance machines (DSSRM): Fundamentals and magnetic force analysis. *IEEE Transactions on Energy Conversion*. 2010;**25**(3):589–597
- [29] Asgar M, Afjei E. Radial force reduction in a new flat-type double-stator switched reluctance motor. *IEEE Transactions on Energy Conversion*. 2016;**31**(1):141–149