Radio Frequency Energy Harvesting - Sources and Techniques

M. Pareja Aparicio, A. Bakkali, J. Pelegri-Sebastia, T. Sogorb, V. Llarío and A. Bou

Additional information is available at the end of the chapter

<http://dx.doi.org/10.5772/61722>

Abstract

Energy harvesting technology is attracting huge attention and holds a promising future for generating electrical power. This process offers various environmentally friendly alternative energy sources. Especially, radio frequency (RF) energy has interesting key attributes that make it very attractive for low-power consumer electronics and wireless sensor networks (WSNs). Ambient RF energy could be provided by commercial RF broadcasting stations such as TV, GSM, Wi-Fi, or radar. In this study, particular attention is given to radio frequency energy harvesting (RFEH) as a green technology, which is very suitable for overcoming problems related to wireless sensor nodes located in harsh environments or inaccessible places. The aim of this paper is to review the progress achievements, the current approaches, and the future directions in the field of RF harvesting energy. Therefore, our aim is to provide RF energy harvesting techniques that open the possibility to power directly electronics or recharge secondary batteries. As a result, this overview is expected to lead to relevant techniques for developing an efficient RF energy harvesting system.

Keywords: Energy Harvesting, Energy Source, Radio Frequency, RFID, Wireless Sensor Networks

1. Introduction

As the demand for wireless sensor networks (WSNs) increases, the need for external power supply drastically increases as well. Besides the problems of recharging and replacing, size and weight, batteries are an exhaustible source with an adverse environmental effect. For these reasons, it is highly desirable to find an alternative solution in order to overcome these power limitations.

The environment represents a relatively good source of available energy compared with the energy stored in batteries or supercapacitors. In this context, energy harvesting, also known as power harvesting and energy scavenging, is an alternative process for primary batteries, where energy is obtained from the ambient environment. An energy harvester typically captures, accumulates, stores, and manages ambient energy in order to convert it into useful electrical energy for autonomous wireless sensor networks. The use of energy scavenging minimizes maintenance and cost operation; therefore, batteries can be eventually removed in WSNs as well as in portable electronic devices.

Many potential ways to harvest energy from environment are available, including solar and wind powers, radio frequency energy and ocean waves, and thermal energy and mechanical vibrations [1–3]. The publications on this topic in the literature are rising to a great extent. Hence, many papers have been published on energy harvesting as a feasible alternative to batteries. Work by Sardini et al. [4] proposed an autonomous sensor powered by mechanical energy coming from airflow velocity. Therefore, the battery-less sensor uses the power harvested in order to provide measurements of air's temperature and velocity. A completely different approach is proposed by Tan et al. in Ref. [5]. The authors have explored a system for wind-powered sensor node. By measuring the equivalent electrical voltage or the frequency of a wind turbine generator output, the wind speed measurement can be indirectly obtained. Based on the sensed wind speed information, the fire control management system provides the spreading condition of a wildfire, so that the fire fighting experts can perform an adequate fire suppression action.

This paper focuses on the energy harvesting technology using electromagnetic energy captured from multiple available ambient RF energy sources, such as TV and radio transmitters, mobile base stations, and microwave radios. This technique is very useful for sensors located in harsh environments or remote places, where other energy sources, such as wind or solar sources, are impracticable. In this context, this work presents an overview of advances achieved in RF harvesting field. The main components of an RF energy harvesting system are discussed in Section 2. Section 3 provides different measurements of the ambient radio frequency energy obtained in published papers. An introduction to RF harvesting energy in radio-frequency identification (RFID) technology is presented in Section 4. Finally, conclusions are drawn in Section 5.

2. Overview of radio frequency energy harvesting system

The basic structure of a radio frequency energy harvesting system consists of a receiving antenna, matching circuit, peak detector, and voltage elevator. Where electromagnetic waves are captured by the antenna, voltage is amplified using the matching circuit, signal is converted to a voltage value thanks to the peak detector, and finally this voltage output is adjusted using the voltage elevator.

The whole system formed by receiving antenna, matching network, and rectifier is usually known as a rectenna or an RF/direct current (DC), which is able to harvest high-frequency

energy in free space and convert it to DC power. The detail of each block is subsequently discussed in order to define specifications and limitations of the power conversion system.

Further, a block of power management and another for energy storage could be integrated into the energy harvesting system. The energy storage subsystem is responsible for storing all the captured energy and providing a constant output voltage.

Energy harvester is a promising power solution for WSNs. Instead of depending on centralized power sources for charging, sensor devices operate the existing energy in the environment. The DC voltage is stored in a holding capacitor or supercapacitor in order to power supply integrated circuits.

a. Antenna

RF energy harvesting technique needs, as mentioned in the previous section, an efficient antenna with a circuit capable of converting alternating current (AC) voltage to direct current voltage. The front end is a key component to ensure the successful operation of RFEH system. It has the duty of capturing electromagnetic waves, which will be used later to power the integrated system.

Moreover, the antenna efficiency is related to the frequency: energy obtained from an antenna with small bandwidth, than a wideband receiver antenna used to capture signals from multiple sources. RF antenna can harvest energy from a variety of sources, including broadcast TV signal (ultrahigh frequency (UHF)), mobile phones (900–950 MHz), or Local Area Network (2.45 GHz/ 5.8 GHz).

In principle, power harvested from RF signals is enough to supply microelectronic devices gradually; however, this power can dramatically rise by using an array configuration. Therefore, the maximum possible power can be achieved by properly arranging similar antennas (with the same matching circuit and power management) [6, 7], or by using antennas operating at different frequencies [8]. The trend is to include the antenna, usually patch antenna, and the rectifier on the same printed circuit board [9].

The equivalent electrical model of an antenna is an AC voltage source (V_{ant}) with series impedance (Z_{ant}), as illustrated in Figure 1. Amplitude of the AC voltage source depends on the available power (P_{AV}) and the real impedance (R_{ant}). The average power received (P_{AV}) depends on the power density (S) and the antenna effective area (A_e), as expressed in Eq. (1):

$$P_{AV} = S \cdot A \tag{1}$$

Apparent power received (S) can be calculated using the Friis transmission equation (Eq. (2)). S is a function of several parameters: the transmitted power (P_{TX}), the transmitting antenna gain (G_{TX}), the received antenna gain (G_{RX}), the wavelength (λ), loss factor (L_C), and the distance between transmitter and antenna (r):

$$S = P_{TX} \cdot G_{TX} \cdot G_{RX} \cdot L_C \cdot \left(\frac{\lambda}{4 \cdot \pi \cdot r} \right) \tag{2}$$

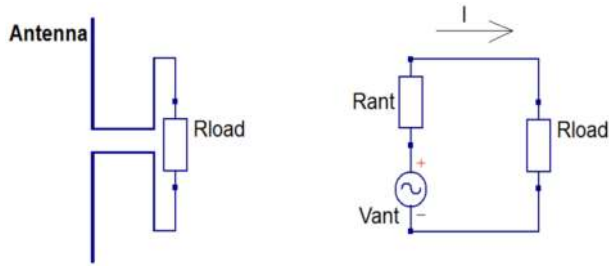

Figure 1. Antenna equivalent circuit.

The antenna impedance can be expressed by Eq. (3), where the real component is presented by two resistances: one is related to the material used (R_{loss}) and the other is due to the electromagnetic wave radiation (R_s). However, the imaginary component X_{ant} depends on the antenna structure, usually inductive for a loop antenna and capacitive for a patch antenna. Common Z_{ant} values are 300Ω (closed dipole antenna), 75Ω (open dipole antenna), and 50Ω (wireless systems):

$$Z_{\text{ant}} = (R_{\text{loss}} + R_s) + jX_{\text{ant}} = R_{\text{ant}} + jX \quad (3)$$

Indeed, the concept of RF energy harvesting requires an efficient antenna with high performances. Hence, several researchers focused on highly efficient receivers for electromagnetic wave harvesting. Moon and Jung [10] proposed an interesting antenna design for RF energy harvesting system based on two radiators: the main one is a printed dipole radiator and the parasitic one with a loop structure. The parasitic radiator is suitable for receiving RF power in all directions from the main radiator. However, Xie et al. [11] designed a hexagonal microstrip patch antenna array that operates at 915 MHz, in order to achieve the maximum possible RF energy to convert into DC power for lighting light-emitting diodes (LED).

b. Matching circuit

Matching circuits are essentially used to match the antenna impedance to the rectifier circuit in order to achieve maximum power and improve efficiency, by using coils and capacitors [12, 13]. Several matching circuits are available; however, the main configurations that have been proposed are the transformer, the parallel coil, and the LC network, as shown in Figure 2.

For economic reasons, RFID tags and sensor networks use the shunt inductor and the LC network as matching networks instead of the transformer. Moreover, it is desirable for high-impedance antennas (e.g., dipole antenna) to use the parallel coil [12], whereas the LC network is used for small impedance antennas (e.g., Wi-Fi antenna) or when the available power P_{AV} is low [13].

As previously mentioned, the impedance matching circuit is designed to increase the voltage gain and reduce the transmission loss; this means that the impedance seen by the antenna is

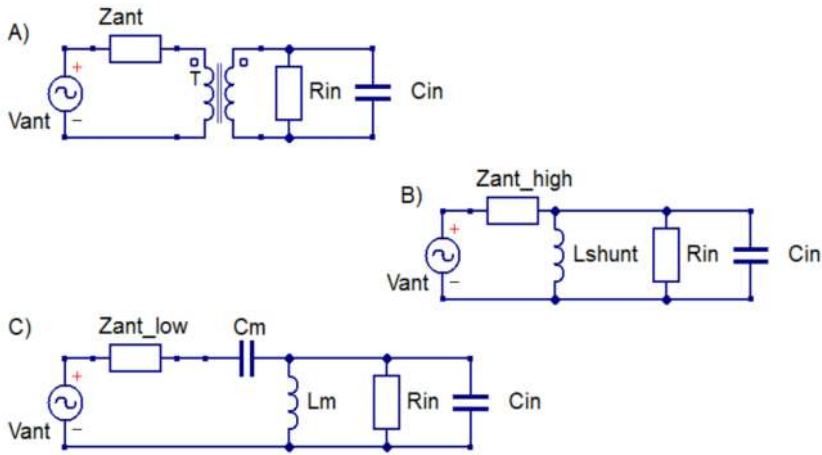

Figure 2. Matching network circuits: transformer (a), shunt inductor (b), and LC network (c) [12].

equal to the impedance of antenna [14]. The equivalent circuit and the normalized input voltage are shown in Figure 3. Therefore, V_{in} reaches its maximum level when α is equal to the unit, that is, when R_{in} and R_{ant} are equal.

In radio frequency range, the impedance mismatch between the antenna and rectifier could be replaced by a tuning circuit, in order to adjust the receiver frequency [15, 16]. Multiband commercial antennas are typically equipped with filters [17]; however, the output power is lower than it should be [18]. An example of matching circuit impedance intended for television frequency band, formed by passive components and using the LC network, is discussed in Ref. [19].

Further, a shorted stub can be added to the matching circuit, which is represented by a wire with a length depending on wavelength and finishing on the ground plane. Therefore, the system performs as a tank circuit [9, 20]. However, in Ref. [21], the authors proposed an approximate method using a resistor in series with antenna. The current trend is to include antenna, impedance matching, and rectifier in a printed circuit board [19]. The RFEH system is designed on the same printed circuit board avoiding cable losses (cf. Figure 4).

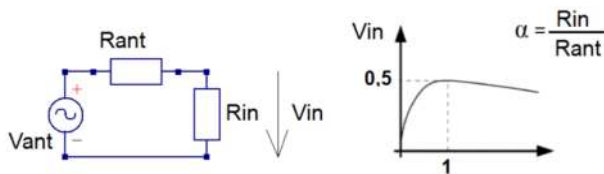

Figure 3. Transfer energy on matching circuit [14].

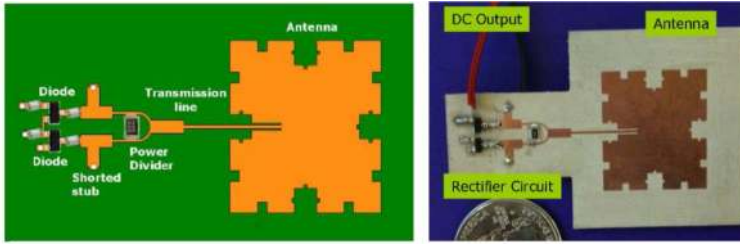

Figure 4. RFEH design circuit [9].

c. Rectifier

Radio frequency signal captured by the antenna is an alternating current (AC) signal. In order to get a DC signal out of AC signal and improve the efficiency of the RF–DC power conversion system, a rectifier circuit is used. Rectification subsystem or peak detector, which has been already used on crystal radio, consists only of diodes and capacitors.

When the distance from the RF source is far and the received power is not high enough, the rectifier input needs to be amplified in order to power the circuit (sensor networks or RFID tags require at least 3.3 V). The most popular rectifier used is a modified Dickson multiplier, which has the function of rectifying the radio frequency signal and increases the DC voltage. Moreover, many works have used complementary metal–oxide–semiconductor (CMOS) technology to replace the diodes [13, 22]. Other different ways to rectify AC signals have been introduced, including Greinacher circuit or voltage doubler [23], Cockcroft–Walton circuit [20], multiplier resonant [24, 25], Villance multiplier [26], and boost converter [23, 27].

Choice of rectification circuits depends on the radio frequency signal and power received, since different values of DC voltage could be obtained with the same circuit and different radio frequency sources. The multiplier is usually formed using different stages; each stage includes two diodes and two capacitors. The voltage output is more important with a large number of stages. However, because diode loss increases with the stage number, the system efficiency is affected. The impact of rectifier stage number on the power received is presented in Figure 5. For the low received power ($P_{in} < 0$ dBm), the output voltage (V_{out}) is practically independent of the stage number, while efficiency is good for fewer stages. The high voltage range is achieved when the power received is around 0 dBm and the number of stages is large, whereas efficiency decreases when V_{out} reached its maximum. Therefore, it seems difficult to achieve a good design due to the received signal influence on the RFEH system.

Multiplier efficiency (η_{rect}) depends on the input and output powers ($P_{in_{rect}}$ and $P_{out_{rect}}$ respectively), as expressed in Eq. (4). However, the efficiency of RFEH system (η_{RFEH}) depends on the power generated ($P_{out_{dc}}$) and the power received ($P_{in_{rf}}$). The η_{RFEH} can be calculated using Eq. (5):

$$\eta_{rect} = P_{out_{rect}} / P_{in_{rect}} \quad (4)$$

$$\eta_{\text{RFEH}} = P_{\text{out_dc}} / P_{\text{in_rf}} \quad (5)$$

Diodes commonly used as rectification components are Schottky diodes, while Germanium diodes are also used for radio circuit of the peak detector. Performance analysis of some Schottky diodes is outlined in Table 1.

Device	I_s (A)	R_s (Ω)	C_{j0} (pF)	V_f (V)	B_V (V)	I_{BV} (A)
SMS7630	5E-6	20	0.14	0.34	2	1E-04
HSMS-282X	2.2E-8	6	0.7	0.65	15	1E-04
HSCHE-9161	12E-6	50	0.03	0.26	10	10E-12

Table 1. Parameters of Schottky diodes.

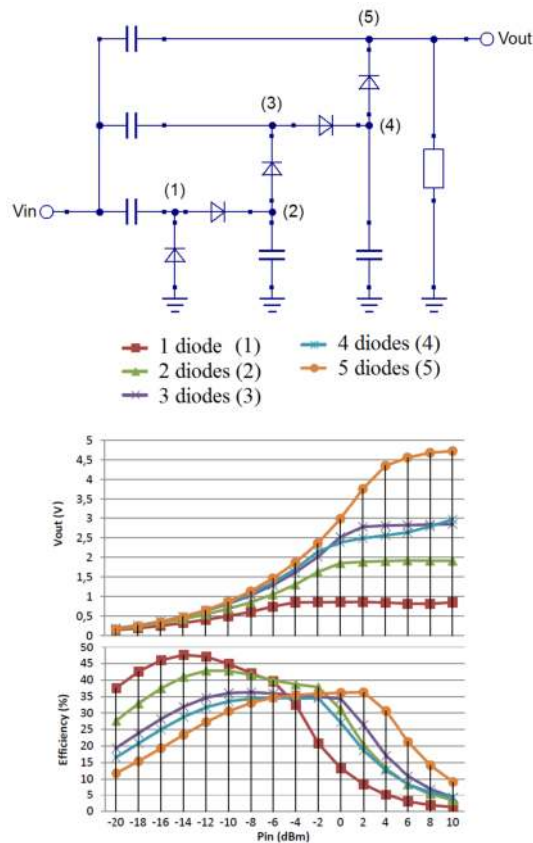

Figure 5. Stages multiplier versus output voltage and efficiency [28].

Rectifier equivalent circuit, as shown in Figure 6, is modeled by an input impedance $R_{in} \parallel C_{in}$, in addition to a current source depending on the input voltage, and a constant output resistor that presents the rectifier losses [14]. Output voltage value is determined by the stage number (N) of the multiplier.

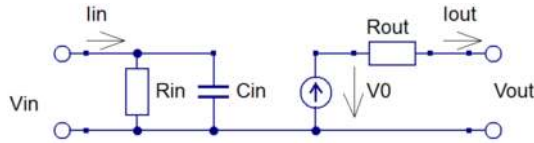

Figure 6. Multiplier equivalent circuit [14].

Further, multiplier equivalent circuit can also be obtained by using the mathematical equation [14], model simulation [12], or measurement [26].

3. Measurement of ambient radio frequency energy harvesting

As mentioned previously, an RFEH system is able to recover energy from available RF electromagnetic sources present in the ambient environment such as phone stations, radio, and television broadcasting. In Table 2, the main features of RFEH systems proposed in literature are summarized. As can be seen, the energy harvested is significantly very low that involves a decrease of the circuit performance.

Figure 7 shows the received power as a function of distance from RF power source at UHF. As it can be seen, for a free space distance of 40 m, the maximum theoretical power available for conversion is $1 \mu\text{W}$ and $7 \mu\text{W}$ for frequencies of 2.4 GHz and 900 MHz, respectively.

As mentioned above, many other sources of energy, including vibration, photovoltaic, and thermal, have been cleverly converted to useful energy using a variety of techniques. Table 2 presents some harvesting methods with their power generation capability.

Despite the fact that the power density of RFEH is lower than other sources, this powering method can be useful, especially for sensor nodes located in harsh environments, where other sources like wind or solar energies are not feasible.

Energy source	Power density (l/cm^2)
RF	0.01 to $0.1 \mu\text{W}$
Vibration	4 to $100 \mu\text{W}$
Photovoltaic	$10 \mu\text{W}$ to 10mW
Thermal	$20 \mu\text{W}$ to 10mW

Table 2. Comparison of energy harvesting sources [29].

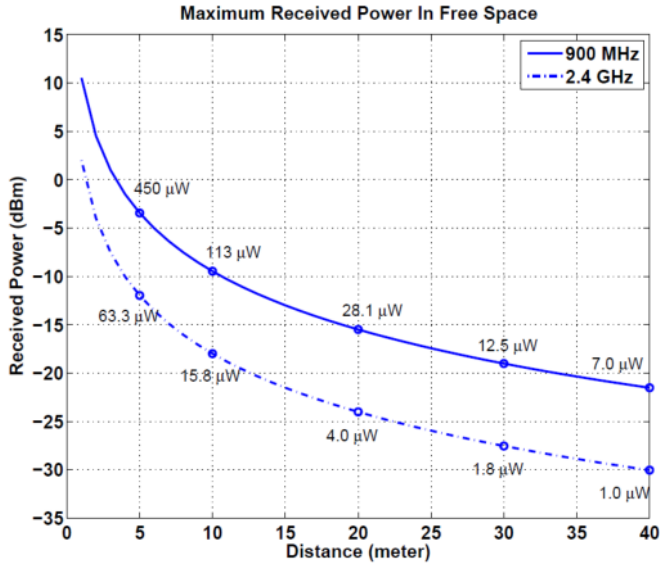

Figure 7. Received power versus distance [13].

Therefore, RFEH is a promising technology and an alternative source of energy to power the sensor nodes. As a result, these devices do not require any battery since they can use the power harvested from the ambient RF energy. Since battery replacement or its recharging is impracticable, autonomous WSNs need to exploit the RF ambient energy harvesting especially for long-duration applications.

It is important to note that the power density available depends on the radio frequency source and the distance. Values of this power are presented in Table 3 for different RF energy sources.

Source	Distance	Density power available
50kW AM radio station	5/10 [km]	159/40 [$\mu\text{W}/\text{m}^2$]
100W GSM base station	100/500/1000 [m]	800/32/8 [$\mu\text{W}/\text{m}^2$]
0,5 mobile phone	1/5/10 [m]	40/1.6/0.4 [mW/m ²]
1W Wi-Fi router	1/5/10 [m]	80/3.2/0.84 [mW/m ²]

Table 3. Power density on RFEH with different sources [30].

Table 4 provides a summary of results obtained from various studies in the RFEH field, with a brief description of the significant components used: RF source, antenna, matching circuit, and rectifier circuit.

Reference	Description	Frequency	Maximum Voltage	Maximum Performance	Power/Energy
BHA2006 [6]	Patch antenna array is used (4×4). Maximum power received is -10 dBm	2.4 GHz	n/a	n/a	373.248 μW
MIK2011a [8]	Using the same antenna for different frequency band, TV signal (74% to 42.6%) and RFID reader	470–770 MHz 950–956 MHz	n/a	74% (Pin=0 dBm) 54% (Pin=-20 dBm) 2% (Pin=-40 dBm)	0.74 mW (Pin=0 dBm) 5.4 μW (Pin=-20 dBm) 2 nW (Pin=-40 dBm)
UR2010 [15]	FM radio signals with loop antenna, tuned circuit, and Dickson charge pump 6 stages. AA supercapacitor is used to store energy	945 kHz	520 mV	n/a	60.4 μJ
BOU2010 [18]	Matching circuit using limited filter and rectifier with 1 stage. Maximum power received is -42 dBm (63 nW)	2.4 GHz	n/a	0.60%	400 pW
MIK2011b [31]	Patch antenna, matching circuit, and rectifier with 1 stage and boost converter	500–700 MHz	134 mV (Pin=-15 dBm)	18.2% (Pin=-20 dBm)	n/a
MIK2011c [32]	Microwave tooth antenna with filter, to matching circuit. A supercapacitor is used to store energy	470–505 MHz 520–560 MHz	3.7 V	> 50% (Pin=-5 dBm)	30 mW
AMA2011 [33]	Commercial UHF antenna and Dickson multiplier with 4 stages	UHF band	6 V	n/a	n/a

Table 4. Review of measurement of RFEH.

A comparison of the commercial requirements for sensor network nodes is presented in Table 5. Therefore, the use of RFEH for WSNs depends especially on the application, the distance from the base station, the radio-frequency band, distance between nodes, etc.

The results deduced from Tables 4 and 5 indicate that the RFEH is insufficient as a primary power source. Thus, it can be combined with other energy harvesting sources. As an example, for outdoor applications, when the base station is away from the sensor nodes, RFEH can be combined with photovoltaic energy. In a similar way, for human body sensors, this energy can be combined with thermal or vibration energy.

However, when the WSN is near to the base station, it is possible to use only RFEH as the power supply; in this case, the antenna and matching circuit must be compatible with the base station frequency. This system cannot be used for generic applications.

Operation Conditions	Crossbow MICAz	Wasp mote	Intel IMote2	T mote Sky (Telosb)
<i>Radio standard</i>	IEEE 802.15.4/Zig Bee	IEEE 802.15.4/Zig Bee	IEEE 802.15.4	IEEE 802.15.4
<i>Typical range</i>	100 m outdoor 30 m indoor	500 m	30 m	125 m outdoor 50 m indoor
<i>Data rate (Kbps)</i>	250	250	250	250
<i>Sleep mode</i>	15 μ A	62 μ A	390 μ A	2.6 μ A
<i>Processor consumption</i>	8 mA	9 mA	31–53 mA	500 μ A
<i>RX</i>	19.7 mA	49.56 mA	44 mA	18.8 mA
<i>TX</i>	17.4 mA	50.26 mA	44 mA	17.4 mA
<i>Supply voltage (min)</i>	2.7 V	3.3 V	3.2 V	2.1 V

Table 5. Comparison of power consumption of sensor network nodes [34, 35].

Further, the energy-harvested design for powering sensor networks depends on different modes: sleep, transmission, reception, and minimal supply voltage required to run, (cf. Table 5), that is, it depends on the application.

4. RFEH and RFID

The RF harvesting technique is certainly a viable option for wide-range applications, including the passive RFID tags, where the signal used for communication is also used for powering [36, 37]. Therefore, RFID tags typically use the radio signal from a dedicated interrogator for power and communication. The antenna used could be designed for power harvesting and communication.

Table 6 shows the results of various studies that have been focused on RFID system powered by RFEH.

Reference	Frequency Band	Standard	Power Transmission	Antenna Gain	Distance	Efficient	Voltage	Consumption
<i>OLG2010[9]</i>	2.45 GHz	4 W EIRP	n/a	n/a	3.1–2.1 m	70%	1.6 V	1.6 V LED
<i>KIT2005[20]</i>	900 MHz	4 W EIRP	100 mW	7.5 dBi	3–3.5 m	n/a	0.6 V	2 μ A
<i>KIT2004[30]</i>	2.45 GHz	RCD STD-1300	mW	20 dBi	10 m	40%	> 1 V	30 μ W

Table 6. Review of RFID system using RFEH power.

It is well known that RFID systems generate and radiate electromagnetic waves; thus, they are justifiably classified as radio systems. However, they are not considered as RFEH systems, since they get their energy from readers. Hence, an RFID system uses the radio frequency signal in order to power and activate the tag, whereas in RFEH system, the energy source is usually not controlled by the reader. The identification process is presented in Figure 8. The energy is sent by using a radio frequency signal in order to receive the information from tags. Furthermore, the passive tags, as no battery, are smaller and lighter than the active and semi-passive tags.

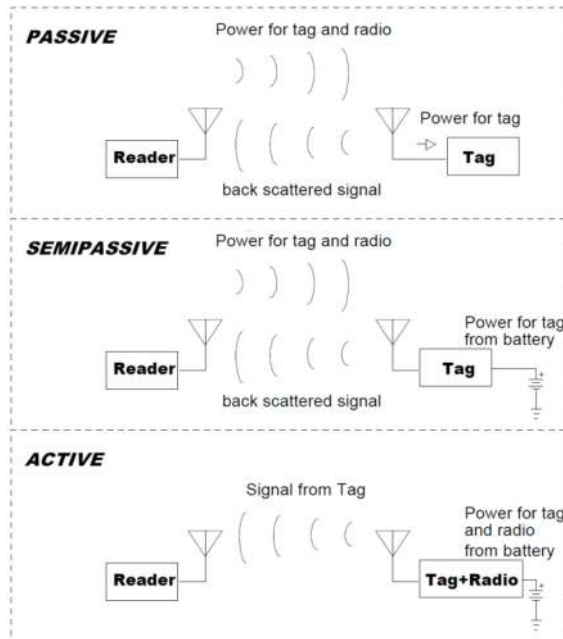

Figure 8. RFID systems [37].

Regarding RFID frequencies, there are four main frequency bands available for RFID systems:

- Low frequency (LF: 125–134 KHz).
- High frequency (HF: 13.56 MHz).
- Ultrahigh frequency (UHF: 956 MHz in USA and 866 MHz in Europe).
- Microwave band (2.45–5.8 GHz).

Despite the excellent progress made in the RFID technology, several issues still need to be addressed appropriately related to reliability, security, speed of communications, and evolution to a global standard. Therefore, it is highly suitable to develop compact transponders applicable for a long reading range, with a low price and a long life.

5. Conclusion

RF energy harvesters open up new exciting possibilities in wireless communication and networking by enabling energy self-sufficient, environmentally friendly operation with practically infinite lifetimes, and synergistic distribution of information and energy in networks. The energy is harvested from commercial RF broadcasting stations, especially for powering wireless sensor networks or other applications that require only a small amount of energy (10^{-3} to 10^{-6} W). Further, RFID sensors can be powered by scavenging ambient power from radio frequency signals in order to prolong the lifetime to several decades and reduce maintenance costs.

This study is expected to provide a survey that offers a holistic view of RF energy harvesting process. Therefore, this paper covers various approaches of RF energy harvesting in order to meet the future demand for self-powered devices. All the subsystems of an RF harvester are discussed, including the receiving antenna, the matching circuit, and the rectifier. Hence, several research groups have proposed RF harvesters in order to achieve optimum power density and ensure a permanent power supply. Finally, RF energy harvesting is an emerging and active research area where more advancement is required to harvest energy efficiently.

Future works can be made to design antennas operating at several frequencies including at 2.3 GHz (Wimax), 2.4 GHz (WLAN), 2.6 GHz (LTE/4G), as well as 5.2 GHz (WLAN). Furthermore, the DC voltage of the rectenna needs to be improved in order to ensure that the optimum power transfer can be delivered.

Acknowledgements

This study was supported in part by the EMMAG Program, 2014, funded by the European Commission.

Author details

M. Pareja Aparicio¹, A. Bakkali^{1,2}, J. Pelegri-Sebastia^{1*}, T. Sogorb¹, V. Llario¹ and A. Bou¹

*Address all correspondence to: jpelegri@upv.es

¹ Research Institute for Integrated Management of Coastal Areas, Universitat Politècnica de Valencia, Spain

² Laboratory of Innovative Technologies, Abdelmalek Essaadi University, Morocco

References

- [1] S. Sudevalayam, P. Kulkarni, Energy Harvesting Sensor Nodes: Survey and Implications, *IEEE Communications Surveys & Tutorials*, Vol. 13, No. 3, pp.443-461, 2011.
- [2] M. T. Penella Lopez, *Methods and Circuits for the Efficient Management of Power and Energy in Autonomous Sensors*, Doctorate Thesis, University Polytechnic of Catalunya, 2010.
- [3] S. Chalasani, J. M. Conrad, A Survey of Energy Harvesting Sources for Embedded Systems, *IEEE Southeast Conference*, IEEE, Huntsville, AL, 2008.
- [4] E. Sardini, M. Serpelloni, Self-Powered Wireless Sensor for Air Temperature and Velocity Measurements with Energy Harvesting Capability, *IEEE Transactions on Instrumentation and Measurement*, Vol. 60, No. 5, pp. 1838-1844, 2011.
- [5] Y. K. Tan, S. K. Panda, Self-Autonomous Wireless Sensor Nodes with Wind Energy Harvesting for Remote Sensing of Wind-Driven Wildfire Spread, *IEEE Transactions on Instrumentation and Measurement*, Vol. 60, No. 4, pp. 1367-1377, 2011.
- [6] S. A. Bhalerao, A. V. Chaudhary, R. B. Deshmukh, R. M. Patrikar, Powering Wireless Sensor Nodes using Ambient RF Energy, *IEEE International Conference on Systems, Man and Cybernetics*, Taiwan, 2006.
- [7] P. Nintanavongsa, U. Muncuk, D. R. Lewis, K. R. Chowdhury, Design Optimization and Implementation for RF Energy Harvesting Circuit, *IEEE Journal on Emerging and Selected Topics in Circuits and Systems*, Vol. 2, Issue 1, pp. 24-33, 2012.
- [8] C. Mikeka, H. Arai, Dual Band RF Energy Harvesting Circuit for Range Enhancement in Passive Tags, *Proceeding of the 5th European Conference on Antennas and Propagation (EUCAP'11)*, IEEE, Rome, 2011.
- [9] U. Olgun, C.C. Chen, J.L. Volakis, Wireless Power Harvesting with Planar Rectennas for 2.45 GHz RFIDs, *International Symposium on Electromagnetic Theory*, IEEE, Berlin, 2010.
- [10] J.I. Moon, Y.B. Jung, Novel Energy Harvesting Antenna Design Using a Parasitic Radiator, *Progress In Electromagnetics Research*, Vol. 142, pp. 545-557, 2013.
- [11] F. Xie, G. M. Yang, W. Geyi, Optimal Design of an Antenna Array for Energy Harvesting, *IEEE Antennas and Wireless Propagation Letters*, Vol. 12, pp.155-158, 2013.
- [12] M.T. Penella, M. Gasulla, *Powering Autonomous Sensors*, Springer Netherlands, Springer Science + Business Media, DOI:10.1007/978-94-007-1573-8, 2011.
- [13] T.T. Le, *Efficient Power Conversion Interface Circuits for Energy Harvesting Applications*, Doctorate Thesis, Oregon State University, 2008.

- [14] J.P. Curty, N. Joehl, F. Krummeanacher, C. Dehollain, M.J. Declercq, A model for u-Power Rectifier Analysis and Design, *IEEE Transactions on Circuits and systems I*, 2005.
- [15] M. Muramatsu, H. Koizumi, An Experimental Result using RF Energy Harvesting Circuit with Dickson Charge Pump, *IEEE Conference on Sustainable Energy Technologies (ICSET)*, Sri Lanka, 2010.
- [16] T. Sogorb, J. V. Llario, J. Pelegrí, R. Lajara, J. Alberola, Studying the Feasibility of Energy Harvesting from Broadcast RF Station for WSN, *IEEE International Instruments and Measurement Technology Conference*, Canada, 2008.
- [17] R.H. Chen, Y. C. Lee, J. S. Sun, Design and Experiment of a Rectifying Antenna for 900 MHz Wireless Power Transmission, *IEEE Asian-Pacific Microwave Conference*, IEEE, Macau, 2008
- [18] D. Bouchouicha, F. Dupont, M. Latrach, L. Ventura, Ambient RF Energy Harvesting, *International Conference on Renewable Energies and Power Quality (ICREPQ'10)*, Spain, 2010.
- [19] U. Olgun, C. C. Chen, J. L. Volakis, Investigation of Rectenna Array Configurations for Enhanced RF Power Harvesting, *IEEE Antennas and Wireless Propagation Letters*, Vol. 10, pp. 262-265, 2011.
- [20] H. Kitayoshi, K. Sawaya, Long Range Passive RFID-Tag for Temperature Monitor System, *Proceeding of International Symposium of Antennas and Propagation (ISAP'06)*, Korea, 2006.
- [21] M. Arrawatia, M. S. Baghini, G. Kumar, RF Energy Harvesting System at 2.67 and 5.8 GHz, *Proceeding of Asia-Pacific Microwave Conference*, IEEE, Yokohama, 2010.
- [22] F. Yuan, *CMOS Circuits for Passive Wireless Microsystems*, Springer-Verlag New York, Springer Science + Business Media, Doi. 10.1007/978-1-4419-7680-2, 2011.
- [23] K. Avuri, K.A. Devi, S. Sadasivam, N.M. Din, C.K. Chakrabarthy, Design of a 377 Ω Patch Antenna for Ambient RF Energy Harvesting at Downlink Frequency of GSM 900, *17th Asian Pacific Conference on Communications*, IEEE, Sabah, 2011.
- [24] M. Pinuela, P.D. Mitchenson, S. Lucyszyn, Analysis of Scalable Rectenna Configurations for Harvesting High Frequency Electromagnetic Ambient Radiation, *International Conference on Micro and Nanotechnology for Power Generation and Energy Conversion Applications*, Belgium, 2010.
- [25] H. Jabbar; Y. S. Song, T. T. Jeong, RF Energy Harvesting System and Circuits for Charging of Mobile Devices, *IEEE Transactions on Consumer Electronics*, Vol.56, No. 1, 2010, pp. 247–253.
- [26] Nimo, D. Grgic, L. M. Reindl, Impedance Optimization of Wireless Electromagnetic Energy Harvester for Maximum Output Efficiency at uW Input Power, Active and

- Passive Smart Structure and Integrated Systems Conference, San Diego, California, 2012.
- [27] F. Kocer, M. P. Flynn, An RF-Powered, Wireless CMOS Temperature Sensor, *IEEE Sensor Journal*, Vol. 6, No. 3, 2006.
- [28] O. A. Escala, Study of the Efficiency of Rectifying Antenna Systems for Energy Harvesting, Thesis for the degree of Engineer, UPC-Barcelona, Spain, 2010.
- [29] Mikeka, H. Arai, Chapter 10: Design Issues in Radio Frequency Energy Harvesting System, *Sustainable Energy Harvesting Technologies – Past, Present and Future*, In-Tech, Croatia, 2011.
- [30] A. M. Zungeru, Li-Minn Ang, S. R. S Prabaharan, K. P. Seng, Radio Frequency Energy Harvesting and Management for Wireless Sensor Networks, *Green Mobile Devices and Networks: Energy Optimization and Scavenging Techniques*, CRC Press Taylor and Francis Group, pp. 341–368, DOI: 10.1201/b10081-16, Oxon, UK, 2011.
- [31] Mikeka, H. Arai, A. Georgiadis, A. Collado, DTV Band Micropower RF Energy-Harvesting Circuit Architecture and Performance Analysis, *IEEE International Conference on RFID-Technologies and Applications*, Sitges, Spain, 2011.
- [32] C. Mikeka, H. Arai, Microwave Tooth for Sensor Power Supply in Battery free Applications, *Proceeding of the Asia-Pacific Microwave Conference*, IEEE, Melbourne, VIC, 2011.
- [33] N. Amaro, S. Valchev, An UHF Wireless Power Harvesting System Analysis and Design, *International Journal of Emerging Sciences*, Vol. 1, No. 4, pp. 625-634, 2011.
- [34] A.Pavone, A. Buonanno, F. D.Corte, Design Considerations for Radio Frequency Energy Harvesting Devices, *Progress in Electromagnetic Research B*, Vol. 45, pp. 19–35, 2012.
- [35] R. Lajara, J.Pelegrí, J. J. Perez, Power Consumption Analysis of Operating Systems for Wireless Sensor Networks. *Sensors 2010*, Vol. 10, pp. 5809–5826.
- [36] H. Kitayoshi, K. Sawaya, Development of a passive RFID-Tag with 10-m Reading Distance under RCR STD-1 Specification, *Proceeding of International Symposium of Antennas and Propagation (ISAP'04)*, Japan, 2004.
- [37] M. Dobkin, *The RF in RFID: Passive UHF RFID in Practice*, Elsevier, Oxford, UK, 2008.