
Challenges in Recovery of Valuable and Hazardous Elements from Bulk Fly Ash and Options for Increasing Fly Ash Utilization

Ajit Behera and Soumya Sanjeeb Mohapatra

Additional information is available at the end of the chapter

<http://dx.doi.org/10.5772/intechopen.69469>

Abstract

Beneficiation of fly ash should require for ensuring the removal of reactive elements to reduce the effect of hazardous impact on our atmosphere and can fill the demand for resources such as metals and rare earths. In this chapter, we concentrate to describe the responsible factors involve in fly ash beneficiation that has a great contribution to our environment. The purpose of the current study is to know the recovery of different minerals; maximum removal of the contaminant, reactivity and neutralization capacity of acid mine drainage (AMD) with fly ash and development of the cost-effective method of disposal of fly ash are achieved. Different beneficiation techniques of fly ash and utilization of fly ash are explained.

Keywords: fly ash, separation technique, fly ash utilization, acid mine drainage

1. Introduction

Fly ash is the finest form of the residue generate from coal combustion in different power plant and industries. The main cause of formation of residue is the conversion of mineral matter present in coal particles during combustion. As a consequence of coal-based power generation industries, a large amount of fly ash produced in thermal power plants create various disposal-related problems. Fly ash continues to be treated as a waste product, which contributes nearly 85% of the fly ash generated in India. It is found that in Odisha specific ash generation is 7–9 MT/day/MW and annual ash generation is about 25 MTPA in 2014–2015 (**Figure 1**), and various areas in which fly ash can be utilized in Odisha are presented in **Figure 2**. In India, ash generation likely to increase to about 180 MTPA after commissioning of proposed power plants, which required 120,000 hectares of land for disposal [1–3]. A large number of power

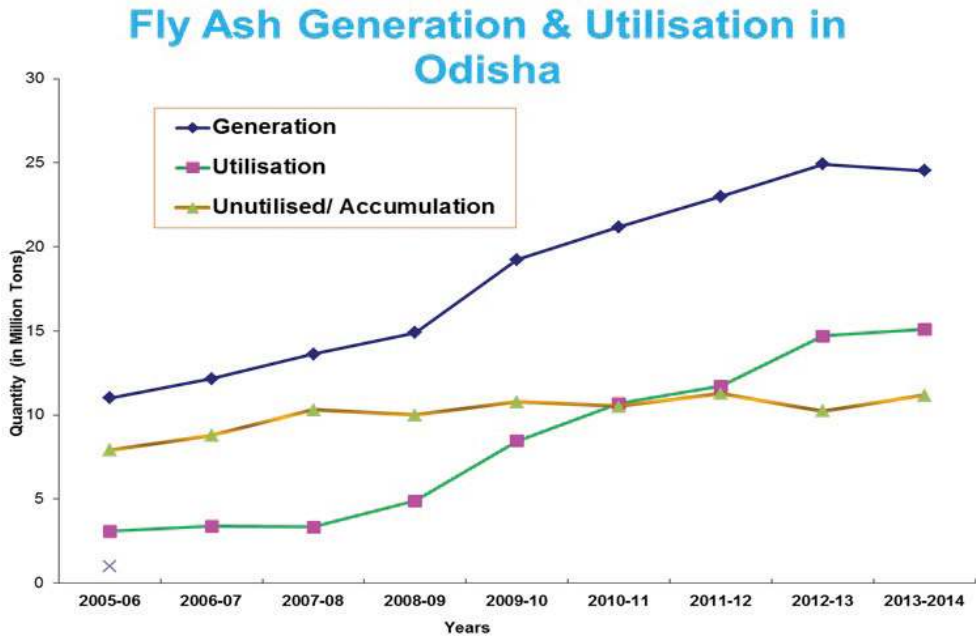


Figure 1. Fly ash generation and utilization in Odisha, India.

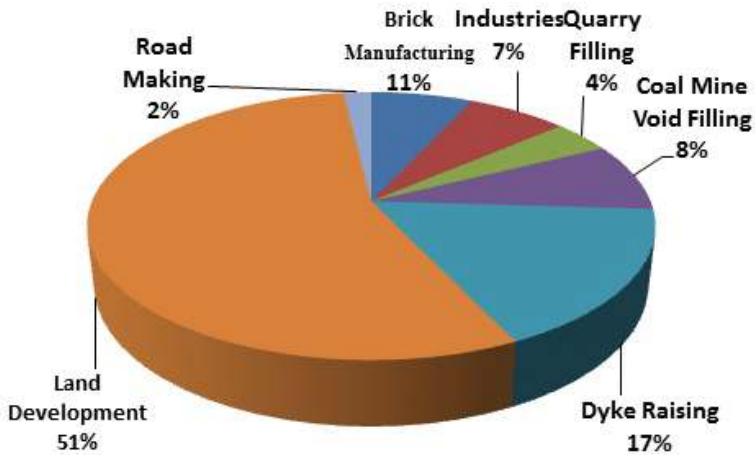


Figure 2. Status of utilization of fly ash in Odisha (2014-2015).

plants in India utilize the wet fly ash that results in degradation of the pozzolanic characteristics of the ash, an essential ingredient for several ash-based products. In India, Fly Ash Mission was set up in 1994 for bulk utilization of ash. Fly ash notification came out in 1999 and

amended in 2009 for enhancing fly ash utilization in various sectors [4]. Fly ashes can be broadly classified on the basis of cementitious properties (Class C: $\text{SiO}_2 + \text{Al}_2\text{O}_3 + \text{Fe}_2\text{O}_3$ minimum 50 wt%) and on the basis of pozzolanic activity (Class F: the sum of the aforementioned oxides exceeds 70 wt%) [5]. Fly ash contains heavy metals (such as Fe, Mn, Al), different elements (such as Zn, Co, Pb, Cr, Cu), toxic/reactive elements (anions like SO_4), radioactive elements and hazardous elements, which give an increasing trend of negative impact to our environment year after year. Thus, in the coming years, fly ash recovery would be a major challenge. Recovering coal ash from the hazardous materials extends the life of available landfill space and reduces the negative impact on the environment. Recovered ash can fulfil the demand for resources such as metals and rare earths. Ash recovery and processing requires very less energy and produce significantly lower emissions than that of traditional mining and processing of natural mineral resources. Processing of fly ash by different techniques to make it more suitable for a specific utilization is known as beneficiation of fly ash.

Fly ash consists of inorganic, incombustible matter present in the coal that has been fused during combustion into a glassy, amorphous structure. Coal ash consists mainly of aluminosilicate glass matrix in addition to crystalline mullite and quartz. The glass phase in coal ash has been attributed to the formation of soluble salts of As, Na, Mg, K, Sr and B on the surface of coal ash spheres, which aids in the reduction in concentration of these elements. Fly ash must meet required ASTM specification before use in concrete. The loss on ignition (LOI) of fly ash is an important tool to measure the presence of unburned carbon. ASTM C618-89a gives the standard specifications for the use of fly ash in Portland cement with LOI limit of 6% [6].

Disposal of fly ash has several problems, including (1) huge requirement of water (about 36 million litres of water each day for a 1000-MW coal-fired power plant using coal with 40% ash) for draining towards the ponds, (2) creation of large wasteland and (3) health and environmental concerns associated with the likelihood of leaching of heavy metals as well as air-borne ash.

2. Environmental impact of fly ash

Fly ash utilization generates the benefit of resource conservation, reduction of waste, avoided emissions with more durable infrastructure and restoration of industrial sites. Major areas of fly ash utilization are as follows: (1) making different types of bricks/blocks for building construction, (2) manufacture of cement and additives in concrete, (3) road construction and (4) embankment, backfill, land development, etc. Land-filled ash also used in same beneficial applications as that of direct ash from the power utility. In other sides, the fly ash contains traces of heavy metals and toxic metals, which are generally below the level that can cause any impact on the environment or public during its normal use. Some elements of fly ash are radioactive. The radioactivity level of fly ash is 1/10th to 1/20th that of the level that causes any harm to environment. This has been tested and certified by Department of Atomic Energy, Government of India. Fly ash particles are generally spherical in shape and range in size from 0.5 to 300 μm , which can cause pulmonary disease. Fly ash able to accumulate toxic elements (Pb, Cr, B, Mo, As and Se) at higher temperatures and here it is considered as an environmental hazard Also due to some elements present in fly ash cause acid drainage from fly ash mine

when in a larger period of contact with rain water or moisture. Therefore, the increased acidity has a range of negative effects calculated from the severity of the pH change. Acidic flow towards river system causes inhospitable to aquatic life that results in periodic fish killing, leading to ecological destruction in watersheds. The site requires expensive active maintenance to prevent the acidic drainage from contaminating the drinking water of nearby communities. Therefore, ash recovery is necessary for social, economic and environmental benefits. The recovery can fill demand for natural resources such as metals, rare earths, lime, sand and aggregate and can increase the life of available landfill space. Nowadays, several types of innovations implement for transforming today's coal ash landfills into accessible, resource-rich stores of needed materials.

3. Composition of fly ash

Fly ash constituents depend upon the source industries specific coal bed but may include substantial amounts of oxide elements such as SiO_2 both in amorphous and crystalline, Al_2O_3 and CaO and trace concentrations of elements (up to hundreds ppm) such as arsenic, beryllium, boron, cadmium, chromium, cobalt, lead, manganese, mercury, molybdenum, selenium, strontium, thallium, vanadium, dioxins and Polycyclic aromatic hydrocarbon (PAH) compounds (Figure 3). Besides the chemical composition, loss on ignition (LOI) reduction will be a requirement and that mentioned for fly ash to meet the specifications most notably the carbon content. Fly ash is a potential source for mineral carbonation by proper chemical co-ordination to capture atmospheric CO_2 . The carbonated material can find application as a substrate and a soil conditioner for agriculture. In other cases, when some other types of fuel used instead of fly ash to

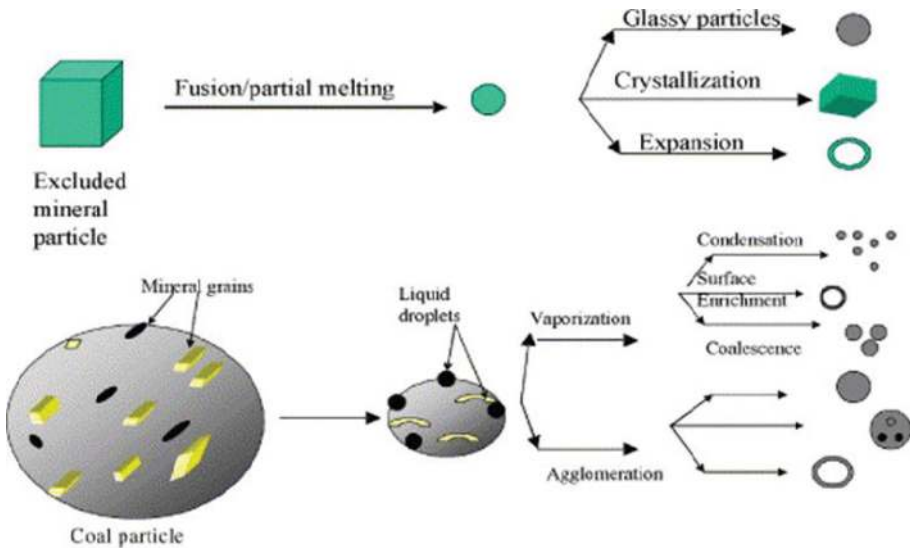


Figure 3. Entrapments of minerals in fly ash during combustion.

produce electricity in an incinerator, this kind of ash may contain higher levels of contaminants than coal ash that is often classified as hazardous waste. Petrologic analyses of fly ash from different industries were conducted using a high-resolution optical microscope. It helps to detect the percentage and aggregation of materials in fly ash. It is found that the unburned carbon is not uniform and there are three carbon types identified: (i) inertinite particles (semifusinite/maceral), (ii) isotropic coke and (iii) anisotropic coke.

4. Extraction techniques

Physical beneficiation processes enhance the utility of fly ash and are based on differences in size, density, magnetic properties, electrostatic properties and other physical properties of the particles. Chemical separation processes are also achieving a success route for beneficiation of the fly ash. Various types of physical and chemical beneficiation techniques of fly ash are given in the next section.

4.1. Sieving

Sieve analysis involves differentiating particle size distributions of fly ash as well as the carbon and minerals in fly ash. In sieve analysis, a stack of sieve with wire mesh screen attached with a column. The mesh size gradually reduces from top to bottom. Generally, a series of four sieve stacks (sizes 90, 75, 45 and 25 μ) and a bottom pan (receiver) were used for sieve analysis. A 100 g sample was put into the top sieve. The column was placed in a mechanical shaker. After the shaking, the material on each sieve is weighed. The weight of the sample of each sieve was then divided by the total weight to give a percentage retained on each sieve [7].

4.2. Air classifier

In this practice, the fly ash feed in the classifier with the main air flow and aerodynamically classifies the material (**Figure 4**). In this process, air pollution material having less in size can be recovered. There is a classifying wheel, in which, a frequency converter equipped to control the wheel speed. The size of the particle can be adjusted during operation by controlling the speed of classifying wheel. Fine particles are transported by the rotor blades along with the classifying air. These fine sizes are then discharged and collected in a suitable filter, whereas the coarse particles are rejected. The coarse material is rinsed intensively in a spiral flow taken from the secondary air stream to remove any last fine powder and are discharged via the coarse material discharge. The ultrafine fly ash produced can utilize in high-strength concrete [8].

4.3. Density separation

Different minerals in the fly ash have different density. If a mixture of minerals with different densities can be put in a liquid with an intermediate density, the grains with densities less than that of the liquid will float and grains with densities greater than the liquid will sink. The fly ash by flotation on water produces cenospheres and fly ash particles can be considered to be cenospheres. Cenospheres are the hollow glass spheres having relative density <1 . The fly ash

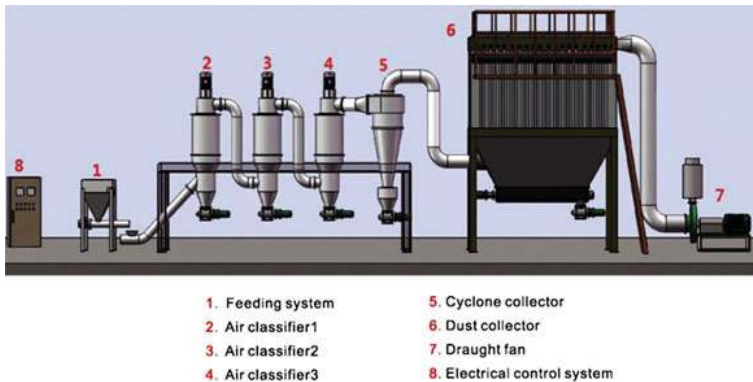


Figure 4. Arrangement of air classifier.

floaters are generally larger (40–250 μm) than the heavier fraction. With unique properties, cenospheres establish fly ash utilization in the refractory and polymer industries. Sphericity of cenospheres, controlled particle size and low density allow the manufacture of polymers with improved properties and/or reduced cost [9]. The applications of cenospheres in thermoplastics have been limited by the high-shear conditions in extrusion and injection moulding. In comparison with other irregularly shaped fly ash fillers, higher volume loadings can be achieved without significantly affecting the rheology and are used in Polyvinyl chloride (PVC), under-body sealants, shoe soles, body fillers, oil well cements, polyurethane and polyester-simulated wooden furniture and fibreglass. Cenospheres are applied in oil well cements that improve the pumpability (sphericity) and maintain the consistency of the mix by maintaining the other components in suspension and limiting the segregation (Figure 5).

4.4. Magnetic separation

Fly ash contains both magnetic and nonmagnetic mineralogical composition and distribution of different minerals in the particle. It is very easy to separate the magnetic and nonmagnetic particles using magnetic belt separator shown in Figure 6. Powdered minerals put on the belt by a feeder and the belt rotates along with the powder. When the powder reached at the magnetic roll, ferromagnetic and strongly paramagnetic particles attract towards the roll and fall on separate pan. There is a use of aerodynamic forces in the configuration to augment the magnetic force of separation. Ferromagnetic and strongly paramagnetic can be separated by adjusting the induced magnetization in the ash. For a certain set of separation conditions in the magnetic separation process, the yields of magnetic fractions were directly proportional to the saturation magnetization of the ferromagnetic components of the ash [10]. Generally, more than 50% recovery of concentrated ferrous materials can be achieved using a magnetic separator.

4.5. Electrostatic separation

Elements that chemically and mineralogically differ present in the fly ash can be recovered using electrostatic precipitator [11]. In the electrostatic separation process, particle size is

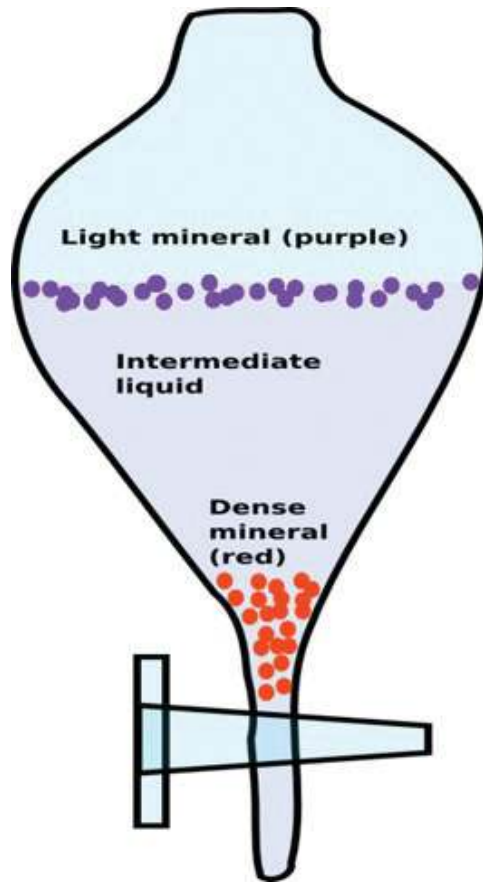


Figure 5. Density separation chamber.

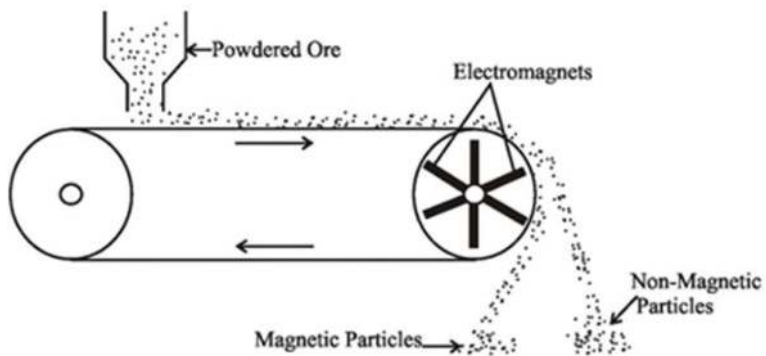


Figure 6. Magnetic separator.

approximately less than 45 μm fraction. Electrostatic parametric selection and careful blending of the various fractions recovered in different holding tank (**Figure 7**). Electrostatic charge induced on the surface plays role when selection is based on electrical susceptibility. During separation of Class F ash, it can separate the two types of glass such as alumina silicate and calcium alumina silicate.

4.6. Triboelectrostatic separation

The triboelectrostatic separation process used to separate unburned carbon and mineral particles. In this process, the organic and mineral particles are charged with opposite polarity (**Figure 8**). When the two different materials are in contact, electrons move until the energy level of the electrons in the two materials at the interface is equalized. The material with a higher affinity for electrons can able to gain electrons and become negatively charge, whereas the material with the lower affinity loses electrons and become positively charge. On contact with a tribocharger, unburned carbons (organic particles) become positively charge and the mineral (inorganic particles) become negatively charge. The differential charging of different particles in the triboelectrostatic method makes it possible to use a static high voltage separator. Carbon particles are attracted to the negative plate and mineral particles are attracted to the positive plate [12].

4.7. Column flotation

Column flotation cells shown in **Figure 9** do not use any mechanical agitation/impellers. Mixing can be done by the turbulence of rising bubbles. In this method, the ground ore is mixed with water to form slurry. The desired mineral becomes hydrophobic in contact with surfactant or collector chemical. But some mineral surfaces are naturally hydrophobic, requiring a trace amount of collector. The collector depends on the nature of the mineral to be recovered. As an example, the collector sodium-ethyl-xanthate ($\text{CH}_3\text{CH}_2\text{OCS}_2\text{Na}$) added in the flotation of PbS to separate it from ZnS. Produced slurry/pulp of hydrophilic and

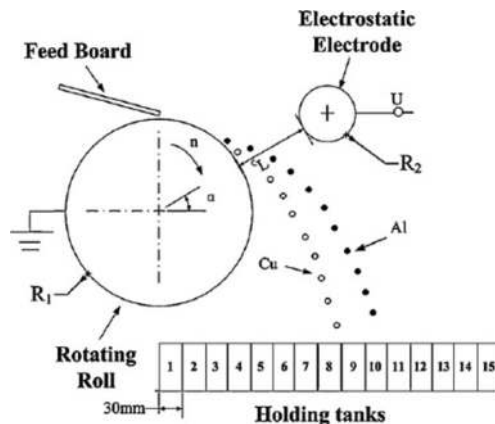


Figure 7. Electrostatic separator.

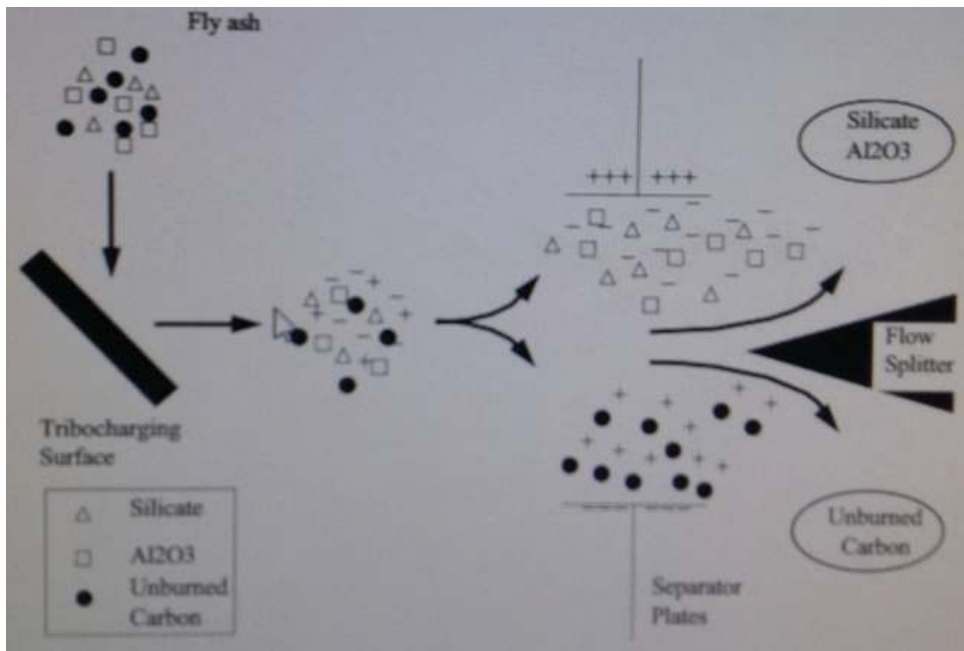


Figure 8. Principles of triboelectrostatic separation.

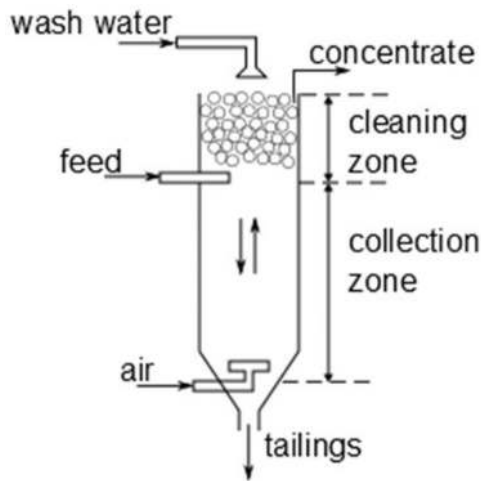


Figure 9. Column flotation cells.

hydrophobic particles introduced in flotation tank that is equipped with bubble riser. The hydrophobic particles attached with the carrier air bubbles rises to the surface and form froth. The froth is collected from the cell that producing a concentrate of the target mineral [13].

4.8. Ultrasonic column agglomeration

Ultrasonic column agglomeration consists of a column, variable speed electrical motor, a solvent recovery tank and stainless steel screen (**Figure 10**). This set-up consists of pre-conditioning treatment in the mix tank and treatment in the column [14]. Ultrasonic wave applied to the slurry mixture in the mix tank and column using a transducer. Ultrasonic wave produced in a frequency range of 0–1 MHz. Slurry of cyclohexane and fly ash was prepared with 5:1 weight ratio. This pre-conditioned slurry exposed to a ultrasonic wave of 0.5 MHz. Then the slurry pumped into the column with the column ultrasonic wave frequency. The agitation speed was controlled. The carbon concentrate was collected on the screen (60-mesh) and air dried. All the carbon recoveries were calculated on a total weight carbon basis.

4.9. Fluidized bed separation (FBA)

Fluidized bed ash formed by fluidized bed combustion in a holding vessel. The quantity of solid particulate placed under appropriate conditions to form a fluid (mixture of solid/fluid) (**Figure 11**). Generally, this solid/fluid mixture is introduced by the pressurized fluid through the particulate medium or by pumping of mixture using fluid type technologies. Now the solid/fluid mixture acts as a normal fluid and able to flow freely under gravity. The fluidized bed is one of the best-known contacting methods. The coal burn with dolomite or limestone in the fluidized bed burning the unburned carbon and releasing SO_2 from exhaust gases. Fly ash collected from the air-controlled equipment and dumped with bottom ash. This blend of this mixture is called FBA [15]. The calcium percentage in FBA is more than in fly ash. FBA has

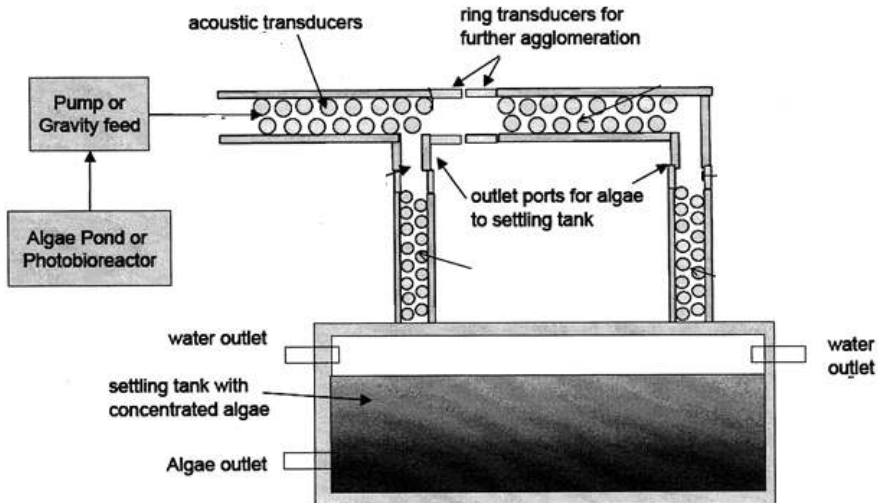


Figure 10. Ultrasonic column agglomeration cell.

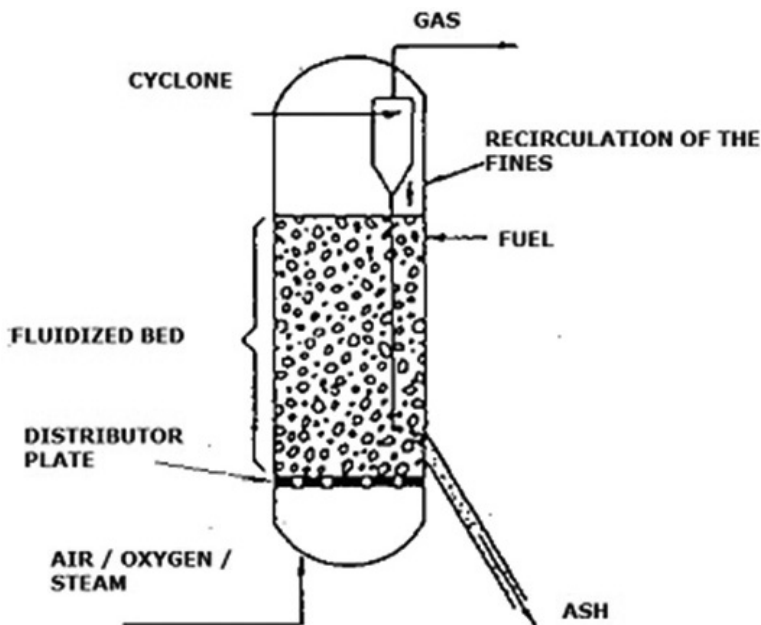
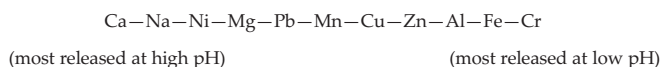


Figure 11. Fluidized bed separation chamber.

been applied to agricultural and brine contaminated lands as a source of micronutrients and as a neutralizer for low pH soils.

4.10. Leaching technique w.r.t pH variation

Different metal present in the fly ash has specific pH, which is able to change according to different reaction. pH has strong effect on their potential release from the fly ash. Hence, each metal had a specific pattern of leaching from ash relative to pH. In high pH (basic) solution, calcium and sodium can release easily, whereas at low pH (acidic) solution, iron and chromium released from fly ash. The release of different elements influenced by the solvent volumes, higher temperatures, longer contact times and lower solid-to-liquid ratios. Varying the condition of leaching, it is easy to concentrate Ni, Cu, Cr and Fe from fly ash. It is observed that as the pH decreases, the order of concentration of different metals is as follows [16]:



Anions (Cl^- , SO_4^{2-}), oxy-anions of Se, As, Mo, B and Cr and cations (Al, Fe, Na, K, Ca, Sr, Ba, Zn, Cu, Cd and Mg) are leached from the fly ash heaps by the wastewater derived from the ash slurry which is to be collected for further concentration [17].

4.11. Froth flotation

In this technique, a mixture of fly ash and a collector was prepared and put in a mixture to ensure the uniformity. The slurry was added into the froth flotation chamber with air pump agitator. Carbon particles were coated and bound with the collector and rose to the surface after attaching with the air bubbles. **Figure 12** shows the top surface of the flotation cell and the collecting beaker when the collector was added to the fly ash sample. Carbon-rich fraction at the top was collected in a pan and the ash became residue at the bottom. Fly ash LOI reduction analysed in this process that depends on the doses of collector/frother [18].

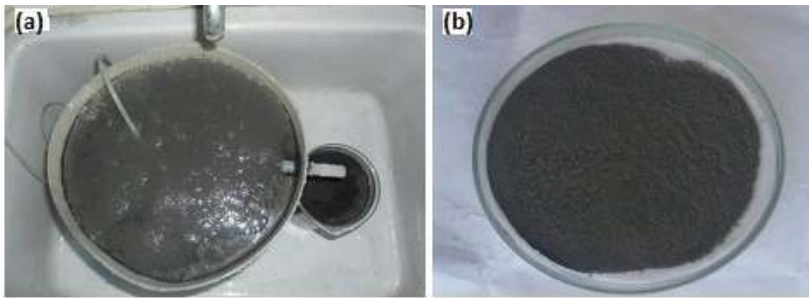


Figure 12. (a) Froth flotation separation with collector dose and (b) bottom fraction from froth flotation.

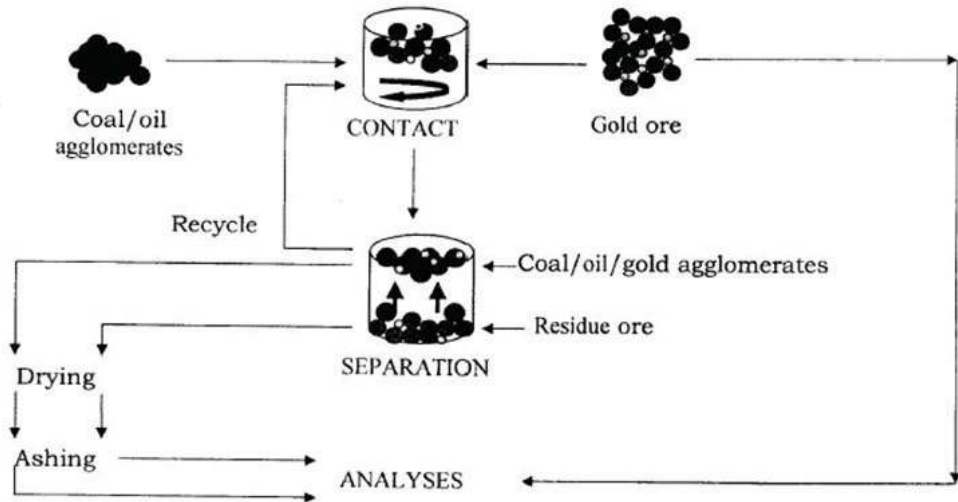


Figure 13. Flowchart of oil agglomeration process.

4.12. Oil agglomeration process

Oil agglomeration process conducted for recovery of unburned carbon. The slurry tank (**Figure 13**) is equipped with a variable speed air motor, a solvent recovery tank and a steel screen (approx. 60 mesh). In the tank, the solvent and fly ash slurry (5:1 weight ratio) was prepared. After proper agitation, the slurry was pumped into the column with air flow. The overflow unburned carbon product was collected on the screen. All the carbon recoveries were calculated on a total weight carbon basis present in the feed fly ash [19].

5. Fly ash utilization

Different technique has been developed for separation of various materials from fly ash that gives a scope for utilization of fly ash from waste materials to a valuable product. The choice of separation processes is highly influenced by associated cost and process complexity.

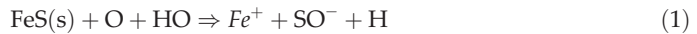
5.1. Treatment of acid mine drainage (AMD)

Acid mine drainage (AMD), acid/metalliferous drainage or acid rock drainage represent the outflow/downstream of acidic water from a mine site. AMD generates naturally when moisture comes into contact with pyrites and sulphidic elements (sulphide of Cu, Au, Ag, Pb, Zn) during mining results in the formation of sulphuric acid. This acidic fluid can dissolve other elements and releases toxic metals. Mostly, this acid comes primarily from oxidation of FeS_2 (iron sulphide, also called as pyrite), which is also form complex compound with various valuable metals. AMD as the coloured fluid is shown in **Figure 14**. AMD is a major problem with many ore mines where the sulphur is bound up with different metal ore. A significant number of coal mines also suffer from AMD. AMD is a major problem found in Africa, Europe, Oceania and North America. Both AMD and coal fly ash individually pose substantial

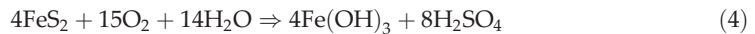
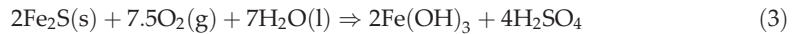
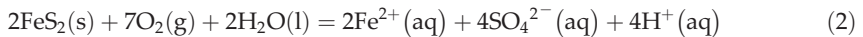


Figure 14. Liquid that drains from fly ash-filled coal mine that is highly acidic.

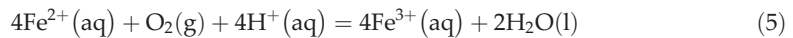
environmental and economic problem. In many localities (construction sites and transportation corridors), the liquid that drains from coal stocks, coal washeries, coal handling facilities and coal waste tips can be highly acidic (as shown in **Figure 1**), and this acidic fluid treated as AMD. It contains high concentrations of heavy metals such as Fe, Mn and Al and anions such as Mg^{2+} , Ca^{2+} , Mn^{2+} and SO_4^{2-} in addition to elements such as Zn, Co, Pb, Cr and Cu, in trace concentrations, which necessitate these AMD fluids to be treated before expose to environmental use. Sulphide minerals or pyrites undergo oxidation reactions, which generate acidity and increase the concentrations of Fe, sulphate and other toxic elements in recipient water bodies (Eq. (1)).



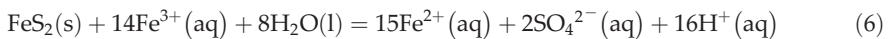
The general reactions for this process are



Oxidation from sulphide to sulphate solubilizes the ferrous iron, which is subsequently oxidized to ferric iron:



Again, the ferric cations produced can also oxidize additional pyrite and reduce into ferrous ions either spontaneously or catalysed by microorganisms:



Some bacteria act as a catalyst in generating ferric hydroxide precipitates known as 'yellow boy', which is also a contributor for the formation of AMD.



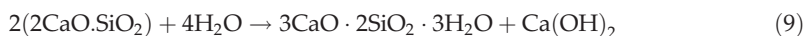
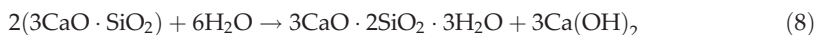
All the above reactions result the release of H^+ , which decrease the pH value that maintains the solubility of the ferric ion.

The water's acidity, toxicity and the yellow coating of iron oxide affect water streams, rivers and aquatic life mainly due to AMD. It is very important task to manage the AMD polluted mine water in expense of active and passive remediation engineering technologies. It is found that AMD can be neutralized by introducing the fly ash. AMD was reacted with coal ash in a two and a half months' equilibration time to produce neutral and alkaline process waters and remove major and minor elements from solution. Concentration of various element depends on their solubility control exist in the solution towards neutralization. Generally, SO_4^{2-} concentrations are not affected by neutralization unless the formation of mineral saturation due to

gypsum [20]. Hence, SO_4^{2-} plays an overall indicator for acid generation after neutralization. Sulphate concentrations were found to be controlled by the precipitation of gypsum ($\text{CaSO}_{4.2}\text{H}_2\text{O}$) at low pH, ettringite ($\text{Ca}_6\text{A}_{12}\text{O}_6(\text{SO}_4)_{3.32}\text{H}_2\text{O}$) at high pH. Hydrolysis reaction among Fe^{3+} , Al^{3+} , Fe^{2+} and Mn^{2+} decreases the pH and dissolve the oxide constituents. Toxins in AMD, including radionuclides, high sulphate levels and numerous other toxic elements (such as Al, Fe, Mn, Hg, As), result a highly acidic fluid. The soluble bases (oxides) in coal fly ash and hydrolysable constituents in AMD results about the final solution weather a dominant acid or basic character at a given contact time.

5.2. Cement

Fly ash has pozzolanic properties and can replace 30% by mass of the Portland cement that utilized for manufacture of the cement [21]. Cement industries utilize more than 50% of fly ash that can add strength and durability to the concrete. It is expected to utilize more than 75% by 2020 with increasing the demand of cement in infrastructure industries. Chemical reactions involve in cement are as follows:



In cement and fly ash matrix, lime is released during hydration of tricalcium silicate ($3\text{CaO} \cdot \text{SiO}_2$) and dicalcium silicate ($2\text{CaO} \cdot \text{SiO}_2$). The tricalcium silicate is more suitable for stabilization with fly ash.

5.3. Waste solidification and stabilization

Stabilization is a process that utilizes additives to reduce the hazardous nature of a waste in the environment. The fly ash can play a major role in the stabilization/solidification process [22]. Fly ash mixed with cement can be used to solidify and stabilize heavy metal sludge. An optimum mixture composed of 45% fly ash, 5% cement and 50% of the industrial sludge could provide the required solidification and stabilization. Fly ash and sludge mixture (without cement) possess the necessary compressive strength for landfill. Generally, there are two best results of mixture used for the production of brick: (i) pulverized sludge + brick clay + fly ash and (ii) pulverized sludge + fly ash + lime.

5.4. Mine void filling

Embankment fill or backfill typically use to create a strong compact base that has low modulus of elasticity ($\approx 50 \text{ kg/cm}^2$), better permeability (10^{-4} to 10^{-6} cm/s), higher shear strength, higher compressibility and less stiff than the magnitude of the surrounding rock. The purpose of the backfill is to restrict the rock stresses and improve the load shedding to mine pillars that leads to less deterioration for ground conditions. Local soil is too weak for backfill and is replaced by compacted fly ash materials. Fly ash embankment provides a better bearing capacity and strength [23]. Generally, fly ash placed and compacted with moisture content to reduce construction time and equipment costs with increasing compact strength. Fly ash embankment

has a loose dry density as low as $650\text{--}810\text{ kg/m}^3$ ($40\text{--}50\text{ lb/ft}^3$). But when it compacted with optimum moisture content ($\approx 20\text{--}35\%$), the dry unit weight of fly ash may be greater than 1620 kg/m^3 (100 lb/ft^3). **Figure 15** shows the mine void filling, in which minimum 0.5 m general soil is covered in between the fly ash layer (1–3 m) for better strength.

5.5. Structural fill and cover material

It is very logical and environmental friendly to utilize and dispose of large volume of fly ash in the form of structural fill or cover material. Fly ash can be utilized to fill in the internal-void of wall, in structural support, bridge abutments. The density, particle size and strength are the more important properties before using as a cover material. Generally, fly ash compacted to a density range ($1120\text{--}1520\text{ kg/m}^3$) for cover material.

5.6. Concrete

Fly ash has cementitious properties that used for production of Portland cement concrete. Note that 30–50% masses of fly ash have been used in massive structures such as foundations and dams and 40–60% of fly ash can be used in structural applications, producing concrete with good mechanical properties and durability. A well-proportioned fly ash concrete mixture will give improved workability, cohesiveness and reduces segregation when compared with a Portland cement concrete of the same slump. Fly ash concrete flows and consolidates are more efficient than a conventional Portland cement concrete when vibrated. Due to spherical particle shape of fly ash, it is very easy to pump and reduce wear on equipment [24].

5.7. Floor blocks and tiles

Floor blocks are the aerated autoclaved concrete made from mixture of fly ash, cement, lime, gypsum and alumina. These blocks are steam cured to get the desire strength, colour, etc. These blocks have better properties such as non-toxicity, earthquake resistant, noise insulation, lightweight, thermal insulation, high compressive strength, high strength to weight ratio, lower water absorption and dimensional accuracy. These blocks can be used in airfield, sub-base and base requirements of all classes of road, side walls, commercial pavements, gardens, parking areas, drive ways, etc. (**Figure 16**). Fly ash is also used for manufacturing superior finish and high strength reflective tiles can be made in different shapes and thicknesses [25].

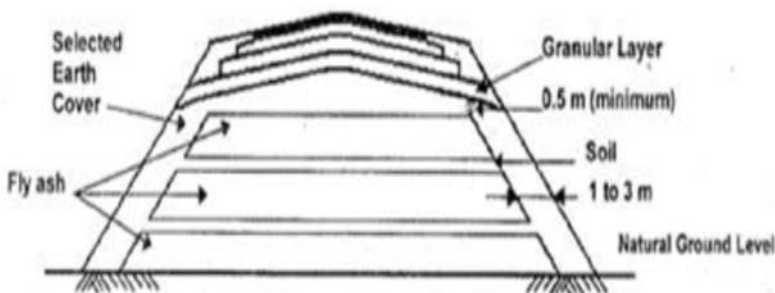


Figure 15. Cross-section of void fills with alternate fly ash and soil.

5.8. Road making

Many gravel roads suffer from reduced bearing capacity mainly during adverse climate conditions (higher temperature or rain). Thus, the soil frost periods will become shorter that lead to degradation of gravel roads. To avoid the reduced bearing capacity, the gravel roads can be stabilised by using fly ash and can give high compression strength. Fly ash can be compacted using moisture content, which is easy to compact using both vibratory and static rollers, and no large lumps to be broken down. Pozzolanic hardening characteristic gives additional strength to the road pavements. Fly ash decreases swelling potential of expansive soils. **Figure 17** shows different fly ash roads which have good surface finish and strength.

5.9. Land development in agriculture

The successful application of fly ash has done in the agriculture field. Fly ash acts as a soil modifier and source of micronutrient. Various seasonal crops have been grown and harvested and there is a significant increase in yield of different crop. It is evident from the crop yield that the addition of 10–200 tonnes fly ash per hectare increased the yield from 5 to 40%. Moreover, fly ash of 10–25% level could be used as a good potting mix material in forestry nurseries to produce hardy seedlings. Fly ash input in agriculture land has proved to minimise the addition of chemical fertilizers and plant growth promoters. But the limiting concentration of fly ash in cultivating land is 25% and used as a secondary nutrient without causing any harm effect on soil health. **Figure 18** shows the cultivation improvement by using the fly ash as a secondary nutrient.



Figure 16. Fly ash floor bricks and tiles.



Figure 17. Utilization of fly ash in different road.

5.10. Reclamation of sea

Many Indian cities are facing shortage of land, and land reclamation from sea can give great success for these cities [26]. A large quantity of fly ash permitted to reclaim the land from sea, basically in coastal urban cities. In 2003, Govt. of India has permitted the use of fly ash for reclamation of sea. Subject to the rules made under the Environment Protection Act (1986), reclamation of sea shall be a permissible method of utilization of fly ash. Land reclamation includes maintaining water and air quality, erosion and damage to land properties, minimizing



Figure 18. Agricultural development by fly ash in Odisha.



Figure 19. Residential complex in Palm Jumeirah, Dubai.

flooding, wildlife and aquatic habitats caused by surface mining. Singapore and Dubai have conducted this type of sea reclamation in a large scale (**Figure 19**). The three alternative ways have been investigated to utilize the waste in sea reclamation projects: (1) Singapore and Japan-based technology, (2) plasma gasification-based technology and (3) strengthened sediment-based land reclamation technology.

6. Conclusion

This chapter discusses the idea about recovery of different elements from fly ash and utilization of fly ash. The approach taken in this chapter has interesting implications for different technology for fly ash beneficiation and fly ash utilization. Lime, sand, aggregate, metals and rare earths recover from fly ash can fulfil demand for natural resources. Fly ash constituents depend upon the source industries specific coal bed but may include substantial amounts of oxide elements and heavy metal. Due to the treatment of fly ash by different extraction techniques, fly ash became environmental friendly. Fly ash utilization as given in this chapter is very essential for future study. Most important thing is the efficient treatment of AMD. Moreover, selective sequential extractions by fly ash help to recover different value-added materials from AMD with their neutralization reactions.

Author details

Ajit Behera^{1*} and Soumya Sanjeeb Mohapatra²

*Address all correspondence to: ajit.behera88@gmail.com

1 Department of Metallurgical & Materials Engineering, National Institute of Technology, Rourkela, Odisha, India

2 Department of Chemical Engineering, National Institute of Technology, Rourkela, Odisha, India

References

- [1] Mishra BK, Das B, Biswal SK, Reddy PSR. Overview of beneficiation, utilization and environmental issues in relation to coal processing. *Proceedings of the Indian National Science Academy*. 2015;**81**(4):725-737. DOI: 10.16943/ptinsa/2015/v81i4/48293
- [2] Malik A, Thapliyal A. Eco-friendly fly ash utilization: Potential for land application. *Journal Critical Reviews in Environmental Science and Technology*. 2009;**39**:333-366. DOI:10.1080/10643380701413690
- [3] Bhattacharjee U, Kandpal TC. Potential of fly ash utilisation in India. *Energy*. 2002;**27**: 151-166
- [4] Dhadse S, Kumari P, Bhagia LJ. Fly ash characterization, utilization and Government initiatives in India CE A review. *Journal of Scientific & Industrial Research*. 2008;**67**:11-18
- [5] Vassilev SV, Vassileva CG. A new approach for the classification of coal fly ashes based on their origin, composition, properties, and behaviour. *Fuel*. 2007;**86**:1490-1512
- [6] Wecharatana M, Liskowitz JW. Properties of high-performance fly ash concrete. *The American Concrete Institute*. 1996;**159**:429-444. <https://www.concrete.org/publications/internationalconcreteabstractsportal.aspx?m¼details&ID¼16769>
- [7] van Riessen A, Chen-Tan N. Beneficiation of collie fly ash for synthesis of geopolymer: Part 1-beneficiation. *Fuel*. 2013;**106**:569-575
- [8] Kiattikomol K, Jaturapitakkul C, Songpiriyakij S, Chutubtim S. A study of ground coarse fly ashes with different finenesses from various sources as pozzolanic materials. *Cement and Concrete Composites*. 2001;**23**(4-5):335-343
- [9] Hemmings R T, Berry E E. Speciation in size and density fractionated fly ash. *MRS online proceedings library*. 1985;**65**:91. DOI: <https://doi.org/10.1557/PROC-65-91>
- [10] Shoumkova AS. Magnetic separation of coal fly ash from Bulgarian power plants. *Waste Management & Research*. 2011;**29**(10):1078-1089
- [11] Kruger RA. Fly ash beneficiation in South Africa: Creating new opportunities in the market-place. *Fuel*. 1997;**76**(8):777-779
- [12] Soong Y, Schoffstall MR, Link TA. Triboelectrostatic beneficiation of fly ash. *Fuel*. 2001;**80**(6): 879-884
- [13] Emre Altun N, Xiaob C, Hwangb J-Y. Separation of unburned carbon from fly ash using a concurrent flotation column. *Fuel Processing Technology*. 2009;**90**(12):1464-1470
- [14] Gray ML, Champagne KJ, Soong Y, Killmeyer RP, Maroto-Valer MM, Andrésen JM, Ciocco MV, Zandhuis PH. Physical cleaning of high carbon fly ash. *Fuel Processing Technology*. 2002;**76**(1):11-21

- [15] Canty GA, Atalay A, Laguros JG, Robertson J, Pandey KK. A preliminary assessment of utilizing fluidized bed ash in landfill liner applications, *Journal of Environmental Science and Health. Part A: Environmental Science and Engineering and Toxicology*, 1995;**30**: 439-459
- [16] Karapanagioti HK, Atalay AS. Laboratory evaluation of ash materials as acid-disturbed land amendments. *GlobalNEST International Journal*. 2001;**3**(1):11-21
- [17] Gitari WM, Petrik LF, Key DL, Okujeni C. Partitioning of major and trace inorganic contaminants in fly ash acid mine drainage derived solid residues. *International Journal of Environmental Science and Technology*. 2010;**7**(3):519-534
- [18] Demirbas A. Demineralization and desulfurization of coals via column froth flotation and different methods. *Energy Conversion and Management*. 2002;**43**(7):885-895
- [19] Graya ML, Champagnea KJ, Soonga Y, Finseth DH. Parametric study of the column oil agglomeration of fly ash. *Fuel*. 2001;**80**(6):867-871
- [20] Geldenhuis S, Bell FG. Acid mine drainage at a coal mine in the eastern Transvaal, South Africa. *Environmental Geology*. 1998;**34**(2):234-242
- [21] Canpolat F, Yılmaz K, Kösec MM, Sümer M, Yurdusev MA. Use of zeolite, coal bottom ash and fly ash as replacement materials in cement production. *Cement and Concrete Research*. 2004;**34**(5):731-735
- [22] Dermatas D, Meng X. Utilization of fly ash for stabilization/solidification of heavy metal contaminated soils. *Engineering Geology*. 2003;**70**(3-4):377-394
- [23] Martin JP, Collins RA, Browning JS, Biehl FJ. Properties and use of fly ashes for embankments. *Journal of Energy Engineering*. 1990;**116**(2). DOI: [http://dx.doi.org/10.1061/\(ASCE\)0733-9402\(1990\)116:2\(71\)](http://dx.doi.org/10.1061/(ASCE)0733-9402(1990)116:2(71))—see more at: [http://ascelibrary.org/doi/pdf/10.1061/\(ASCE\)0733-9402\(1990\)116:2\(71\)#sthash.PYUoT92P.dpuf](http://ascelibrary.org/doi/pdf/10.1061/(ASCE)0733-9402(1990)116:2(71)#sthash.PYUoT92P.dpuf)
- [24] Al-Amoudi O, Maslehuddin M, Asi I. Performance and correlation of the properties of fly ash cement concrete. *Cement, Concrete and Aggregates*. 1996;**18**(2):71-77. <https://doi.org/10.1520/CCA10153J>. ISSN 0149-6123
- [25] Blissett RS, Rowson NA. A review of the multi-component utilisation of coal fly ash. *Fuel*. 2012;**97**:1-23
- [26] Michalkova E, Schwarz M, Pulišová P, Máša B, Sudovský P. Metals recovery from acid mine drainage and possibilities for their utilization. *Polish Journal of Environmental Studies*. 2013;**22**(4):1111-1118

