

# Chemical Bath Deposited CdS for CdTe and Cu(In,Ga)Se<sub>2</sub> Thin Film Solar Cells Processing

M. Estela Calixto<sup>1</sup>, M. L. Albor-Aguilera<sup>2</sup>, M. Tufiño-Velázquez<sup>2</sup>,  
G. Contreras-Puente<sup>2</sup> and A. Morales-Acevedo<sup>3</sup>

<sup>1</sup>*Instituto de Física, Benemérita Universidad Autónoma de Puebla, Puebla,*

<sup>2</sup>*Escuela Superior de Física y Matemáticas, Instituto Politécnico Nacional, México,*

<sup>3</sup>*CINVESTAV-IPN, Departamento de Ingeniería Eléctrica, México,  
México*

## 1. Introduction

Extensive research has been done during the last two decades on cadmium sulfide (CdS) thin films, mainly due to their application to large area electronic devices such as thin film field-effect transistors (Schon et al., 2001) and solar cells (Romeo et al., 2004). For the latter case, chemical bath deposited (CBD) CdS thin films have been used extensively in the processing of CdTe and Cu(In,Ga)Se<sub>2</sub> solar cells, because it is a very simple and inexpensive technique to scale up to deposit CdS thin films for mass production processes and because among other n-type semiconductor materials, it has been found that CdS is the most promising heterojunction partner for these well-known polycrystalline photovoltaic materials. Semiconducting n-type CdS thin films have been widely used as a window layer in solar cells; the quality of the CdS-partner plays an important role into the PV device performance. Usually the deposition of the CdS thin films by CBD is carried out using an alkaline aqueous solution (high pH) composed mainly of some sort of Cd compounds (chloride, nitrate, sulfate salts, etc), thiourea as the sulfide source and ammonia as the complexing agent, which helps to prevent the undesirable homogeneous precipitation by forming complexes with Cd ions, slowing down thus the surface reaction on the substrate. CdS films have to fulfill some important criteria to be used for solar cell applications; they have to be adherent to the substrate and free of pinholes or other physical imperfections. Moreover, due to the requirements imposed to the thickness of the CdS films for the solar cells, it seems to be a function of the relative physical perfection of the film. The better structured CdS films and the fewer flaws present, the thinner the film can be, requirement very important for the processing of Cu(In,Ga)Se<sub>2</sub> based thin film solar cells, thickness ~ 30 - 50 nm. In such case, the growth of the thin CdS film is known to occur via ion by ion reaction, resulting thus into the growth of dense and homogeneous films with mixed cubic/hexagonal lattice structure (Shafarman and Stolt, 2003).

The reason to choose the CBD method to prepare the CdS layers was due to the fact that CBD forms a very compact film that covers the TCO layer, in the case of the CdTe devices and the Cu(In,Ga)Se<sub>2</sub> layer without pinholes. Moreover, the CdS layer in a hetero-junction solar cell must also be highly transparent and form a chemical stable interface with the

Cu(In,Ga)Se<sub>2</sub> and CdTe absorbing layers. The micro-crystalline quality of the film may also be related to the formation of the CdZnS ternary layer in the case of the Cu(In,Ga)Se<sub>2</sub> and CdS<sub>1-x</sub>Te<sub>x</sub> ternary layer for the case of CdTe, at the interface helping to reduce the effects associated to the carrier traps in it. Hence, the deposition conditions and characteristics of the CdS layer may affect strongly the efficiency of the solar cells. We have worked with this assumption in mind for making several experiments that will be described in the following paragraphs. As it will be shown, we have been able to prepare optimum CdS layers by CBD in order to be used in solar cells, and have found that the best performance of CdS/CdTe solar cells is related to the CdS layer with better micro-crystalline quality as revealed by photoluminescence measurements performed to the CdS films.

## 2. CdS thin films by chemical bath deposition technique (CBD)

Chemical bath deposition technique (CBD) has been widely used to deposit films of many different semiconductors. It has proven over the years to be the simplest method available for this purpose, the typical components of a CBD system are a container for the solution bath, the solution itself made up of common chemical reactive salts, the substrate where the deposition of the film is going to take place, a device to control the stirring process and temperature, sometimes a water bath is included to ensure an homogeneous temperature, an schematic diagram of the CBD system is shown in figure 1. The concentrations of the components of the solution bath for CdS can be varied over a working range and each group use its own specific recipe, so there are as many recipes to deposit CdS as research groups working in the subject. The chemical reactive salts are generally of low cost and in general it is necessary to use small quantities. The most important deposition parameters in this technique are the molar concentration, the pH, the deposition temperature, the deposition time, the stirring rate, the complexing agents added to the bath to slowing down the chemical reactions, etc. However, once they have been established these are easy to control. The CdS thin film deposition can be performed over several substrates at a time, and the reproducibility is guaranteed if the deposition parameters are kept the same every time a deposition is done. Substrates can have any area and any configuration, besides they can be of any kind, electrical conductivity is not required.

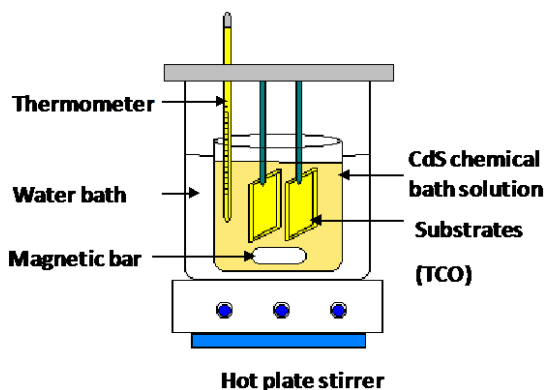

Fig. 1. Schematic diagram of a CdS chemical bath deposition system

Previously we have reported the preparation of monolayers and bi-layers of CdS deposited by chemical bath deposition technique using a solution bath based on CdCl<sub>2</sub> (0.1 M), NH<sub>4</sub>Cl (0.2 M), NH<sub>3</sub> (2 M) and thiourea (0.3 M), maintaining fixed deposition time and temperature conditions and varying the order of application of the CdCl<sub>2</sub> treatment (Contreras-Puente et al., 2006). Initially, the solution is preheated during 5 min prior to add the thiourea, after that the deposition was carried out during 10 min at 75 C, then the second layer (the bi-layer) was deposited at a lower deposition temperature, thus allowing us to control the growth rate of the CdS layer. This was aimed to obtain films with sub-micron and nanometric particle size that could help to solve problems such as partial grain coverage, inter-granular caverns and pinholes. In this way, CdS thin films have been deposited onto SnO<sub>2</sub>:F substrates of 4 cm<sup>2</sup> and 40 cm<sup>2</sup>, respectively.

Figure 2 shows the typical X-ray diffraction pattern obtained with a glancing incidence X-ray diffractometer, for CdS samples prepared in small and large area, respectively. CdS films grow with preferential orientation in the (002), (112) y (004) directions, which correspond to the CdS hexagonal structure (JCPDS 41-049). Small traces of SnO<sub>2</sub>:F are observed (\*) in the X-ray patterns. Figure 3 shows the morphology for both mono and bi-layers of CdS films, respectively. It can be observed that bi-layer films present lower pinhole density and caverns. This is a critical parameter because it gives us the possibility to improve the efficiency of solar cell devices. Several sets of CdTe devices were made and their photovoltaic parameters analyzed, giving conversion efficiencies of ~ 6.5 % for both small and large area devices.

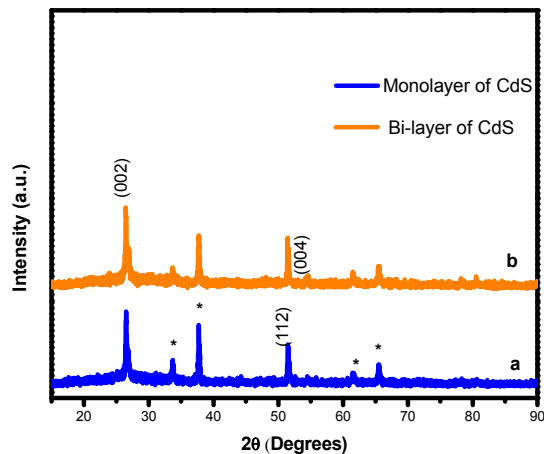

Fig. 2. X-ray diffraction patterns of mono and bi-layers of CdS

Also, we have found that the position of the substrate inside the reactor is an important factor because the kinetics of the growth changes. Figure 4 shows how the transmission response changes with substrate position inside the reactor. The deposition time for all samples was 10 min. According to figure 4a when the substrates are placed horizontally at the bottom of the reactor the CdS film grows a thickness of 150 nm, but the transmission response is poor, when the substrates are placed vertically and suspended with a pair of tweezers inside the reactor the CdS film grows a thickness of 110 nm and the transmission response is ~ 83% (see figure 4b), however in this configuration handling the substrate is

complicated. Because of this, to design a better substrate holder/support was imperative. So, a new support was designed and built to facilitate the access and handling of the samples inside the reactor. Figures 4c and 4d shown the transmission response for mono and bi-layers of CdS deposited using the new substrate support, placed in a vertical configuration inside the reactor, for both cases the values were between 85 - 95 %, being the monolayers the ones that exhibit the best response; however its morphology shows a larger surface defect density. The thickness of these samples is in the order of 100 - 120 nm.

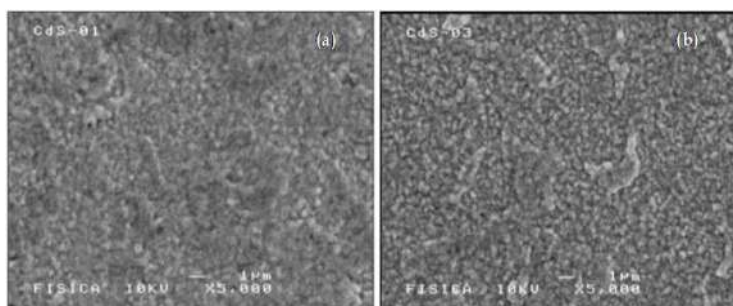

Fig. 3. SEM images of a monolayer and a bi-layer of CdS

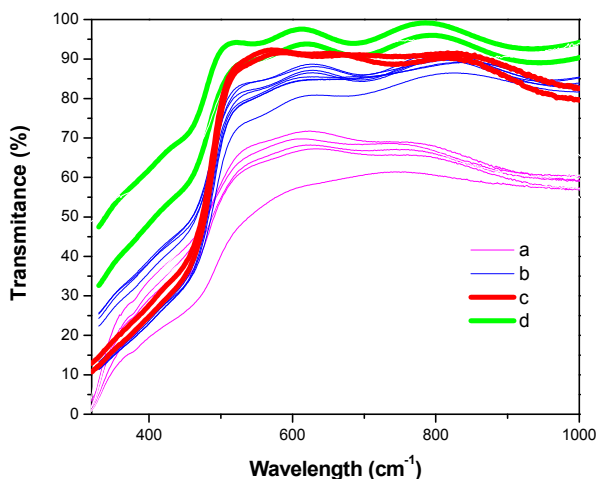

Fig. 4. Transmission response of CdS films as a function of the position inside the reactor

### 2.1 CdS by CBD with a modified configuration

Figure 5 shows the implementation of the new substrate support for the CBD system, from this figure it can be seen that the CBD system is the same as the one shown in figure 1 but with the addition of the substrate holder. It basically holds the substrates vertically and steady, while keeping it free to rotate along with the substrates, in such case the magnetic stirrer is no longer needed. This substrate support can be set to rotate at different speed rates, allowing the growth and kinetics of the reaction of CdS to change and in the best case to improve, improving thus the physical properties of CdS films. The design includes a

direct current motor that has the option to vary the speed rate from 0 to 50 rpm. The motor can move the substrate support made of a Teflon structure that holds up to 4 large area substrates (45 cm<sup>2</sup> each). The principal advantage of using this modified structure is the ability to handle 4 substrates at a time, placing them, inside the reactor containing the solution bath and at the same time starting the rotation, by doing this all the CdS films are expected to have a uniform growth and thickness ~ 120 nm. When the substrate holder is set to rotate inside the reactor, the kinetics of the CdS films growth was clearly affected as shown in figure 6, it can be seen that when the rotating speed goes up, the transmission

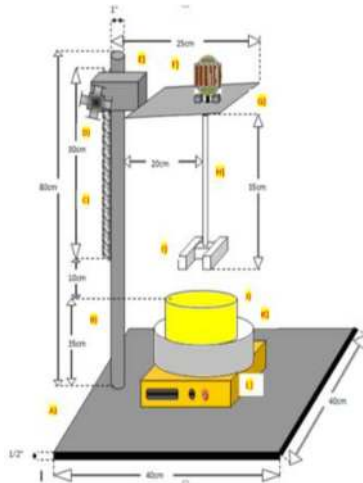

Fig. 5. Schematic diagram of the new substrate holder for the CBD system

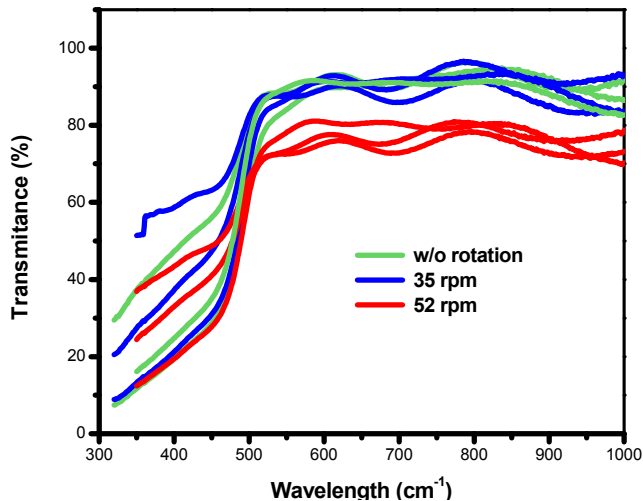

Fig. 6. Transmission response as a function of the rotation rate for CdS films prepared with the new substrate holder.

response decreases to  $\sim 65\%$  compared to the samples prepared without rotation. The deposition time was set to 10 min in all cases, giving thus the growth of CdS films with 120 – 130 nm.

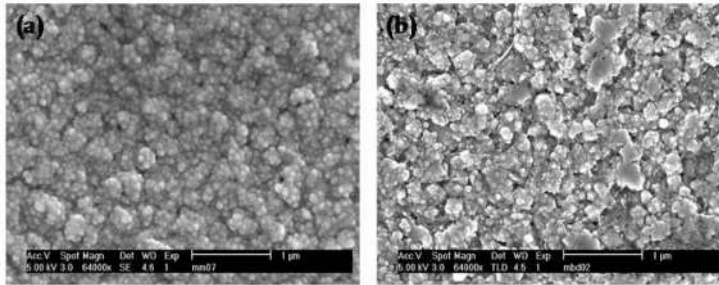

Fig. 7. SEM images of (a) mono and (b) bi-layer of CdS deposited at 35 rpm

Figure 7 shows the SEM images of CdS films prepared using the new substrate holder, according to these images, the morphology of the mono and bi-layers of CdS changes as a function of the rotating speed. Also we can clearly see an increase in the particle size for each case, for the monolayer of CdS the particle size ball-like shape of  $\sim 0.5 - 1 \mu\text{m}$ , but more uniform and compact compared to the particle size that the bi-layers of CdS exhibit with rotation speed set to 35 rpm, flakes-like shape with size of  $\sim 1 - 4 \mu\text{m}$ . No devices have been made so far using CdS films grown with this improved CBD system, studies are being performed and research on the subject is ongoing in order to optimize the deposition conditions, for this case.

### 3. Cu(In,Ga)Se<sub>2</sub> based thin films by co-evaporation technique (PVD)

Semiconducting CuInSe<sub>2</sub> is one of the most promising materials for solar cells applications because of its favorable electronic and optical properties including its direct band gap with high absorption coefficient ( $\sim 10^5 \text{ cm}^{-1}$ ) thus layers of only  $\sim 2 \mu\text{m}$  thickness are required to absorb most of the usable solar radiation and inherent *p*-type conductivity. Besides, the band gap of CuInSe<sub>2</sub> can be modified continuously over a wide range from 1.02 to 2.5 eV by substituting Ga for In or S for Se, which means that this material can be prepared with a different chemical composition. Cu(In,Ga)Se<sub>2</sub> is a very forgiving material so high efficiency devices can be made with a wide tolerance to variations in Cu(In,Ga)Se<sub>2</sub> composition (Rocheleau et al., 1987 and Mitchell K. et al., 1990), grain boundaries are inherently passive so even films with grain sizes less than  $1 \mu\text{m}$  can be used, and device behavior is insensitive to defects at the junction caused by a lattice mismatch or impurities between the Cu(In,Ga)Se<sub>2</sub> and CdS. The latter enables high-efficiency devices to be processed despite exposure of the Cu(In,Ga)Se<sub>2</sub> to air prior to junction formation. For Cu(In,Ga)Se<sub>2</sub> thin film solar cells processing the substrate structure is preferred over the superstrate structure. The substrate structure is composed of a soda lime glass substrate, coated with a Mo layer used as the back contact where the Cu(In,Ga)Se<sub>2</sub> film is deposited. The soda lime glass, which is used in conventional windows, is the most common substrate material used to deposit Cu(In,Ga)Se<sub>2</sub> since it is available in large quantities at low cost. Besides, it has a thermal expansion coefficient of  $9 \times 10^{-6} \text{ K}^{-1}$  (Boyd et al., 1980) which provides a good match to the Cu(In,Ga)Se<sub>2</sub> films. The most important effect of the soda lime glass substrate on

Cu(In,Ga)Se<sub>2</sub> film growth is that it is a natural source of sodium for the growing material. So that, the sodium diffuses through the sputtered Mo back contact, which means that is very important to control the properties of the Mo layer. The presence of sodium promotes the growth of larger grains of the Cu(In,Ga)Se<sub>2</sub> and with a higher degree of preferred orientation in the (112) direction. After Cu(In,Ga)Se<sub>2</sub> deposition, the junction is formed by depositing a CdS layer. Then a high-resistance (HR) ZnO and a doped high-conductivity ZnO:Al layers are subsequently deposited. The ZnO layer reacts with the CdS forming the Cd<sub>x</sub>Zn<sub>1-x</sub>S ternary compound, which is known to have a wider band gap than CdS alone, increasing thus the cell current by increasing the short wavelength (blue) response and at the same time setting the conditions to make a better electric contact. Finally, the deposition of a current-collecting Ni/Al grid completes the device. The highest conversion efficiency for Cu(In,Ga)Se<sub>2</sub> thin film solar cells of ~ 20 % has been achieved by (Repins et al., 2008) using a three stages co-evaporation process. The processing of photovoltaic (PV) quality films is generally carried out via high vacuum techniques, like thermal co-evaporation. This was mainly the reason, we have carried out the implementation and characterization of a thermal co-evaporation system with individual Knudsen cells MBE type, to deposit the Cu(In,Ga)Se<sub>2</sub> thin films (see figure 8). The deposition conditions for each metal source were established previously by doing a deposition profile of temperature data vs. growth rate. The thermal co-evaporation of Cu(In,Ga)Se<sub>2</sub> thin films was carried out using Cu shots 99.999%, Ga ingots 99.9999%, Se shots 99.999% from Alfa Aeser and In wire 99.999% from Kurt J. Lesker, used as received. The depositions were performed on soda lime glass substrates with sputtered Mo with ~ 0.7 μm of thickness. The substrate temperature was > 500 °C, temperature of source materials was set to ensure a growth rate of 1.4, 2.2 and 0.9 Å/s for Cu, In and Ga, respectively for the metals, while keeping a selenium overpressure into the vacuum chamber during film growth.



Fig. 8. Thermal co-evaporation system with Knudsen effusion cells to deposit Cu(In,Ga)Se<sub>2</sub> thin films

Cu(In,Ga)Se<sub>2</sub> thin films were grown with different Ga and Cu ratios ( $Ga/(In+Ga) = 0.28, 0.34$  and  $0.35$  respectively and  $Cu/(In+Ga) = 0.85, 0.83$  and  $0.94$ ). The deposition time was set to 30 min for all cases. All the Cu(In,Ga)Se<sub>2</sub> samples were grown to have 2 - 3  $\mu\text{m}$  thickness and aiming to obtain a relative low content of gallium  $\sim 0.30\%$  (CuIn<sub>0.7</sub>Ga<sub>0.3</sub>Se<sub>2</sub>), while keeping the copper ratio to  $III < 1$  (where  $III = In+Ga$ ), very important criteria to use them directly for solar cell applications, as shown in table 1. For solar cell devices, samples JS17 and JS18 were used, with a chemical composition similar to that of sample JS13.

Chemical composition (at %) by EDS						
Sample	Cu	In	Ga	Se	Ga/III	Cu/III
Reference	22.09	18.84	7.27	51.80	0.28	0.85
CIGS_5	21.27	16.73	8.88	53.69	0.35	0.83
CIGS_8	23.04	16.20	8.24	53.47	0.34	0.94
JS13	24.46	16.87	9.74	48.93	0.37	0.92

Table 1. Results of the chemical composition analysis of the co-evaporated Cu(In,Ga)Se<sub>2</sub> thin films

The morphology of the Cu(In,Ga)Se<sub>2</sub> samples is very uniform, compact and textured, composed of small particles (see figures 9a - 9c). Figure 9d shows the cross-section SEM image and a film thickness  $\sim 3.5\ \mu\text{m}$ , also notice the details of the textured surface of the film, due to the high temperature processing.

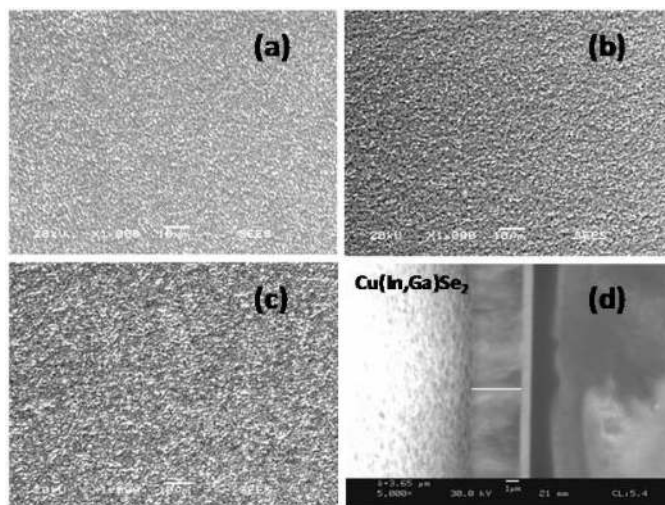

Fig. 9. SEM micrographs of co-evaporated Cu(In,Ga)Se<sub>2</sub> thin films (a - c) and (d) cross section image

The XRD patterns of the films show sharp and well defined peaks, indicating a very good crystallization, the films appear to grow with a strong (112) orientation (see figure 10) and with grain sizes  $\sim 1\ \mu\text{m}$ . The expected shift of the (112) reflection compared to that of the CuInSe<sub>2</sub> is also observed, which is consistent with a film stoichiometry of CuIn<sub>0.7</sub>Ga<sub>0.3</sub>Se<sub>2</sub> (JCPDS 35-1102).



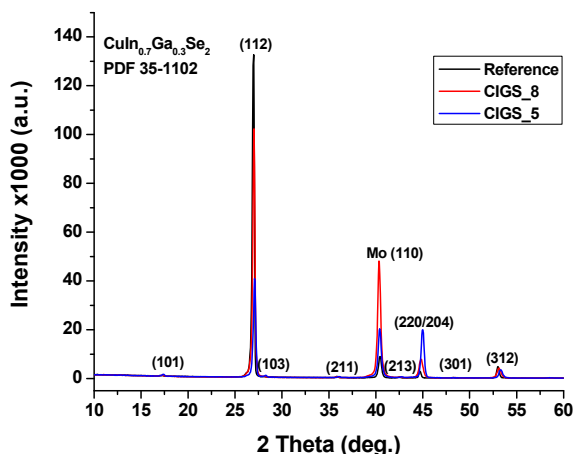

Fig. 10. XRD pattern for Cu(In,Ga)Se<sub>2</sub> thin films thermal co-evaporated

#### 4. CdTe thin films by Close Spaced Vapor Transport (CSVT)

CdTe is a compound semiconductor of II-VI type that has a cubic zincblende (sphalerite) structure with a lattice constant of 6.481 Å. CdTe at room temperature has a direct band gap of 1.5 eV with a temperature coefficient of 2.3–5.4 × 10<sup>-4</sup> eV/K. This band gap is an ideal match to the solar spectrum for a photovoltaic absorber. Similarly to the Cu(In,Ga)Se<sub>2</sub>, the absorption coefficient is large (around 5 × 10<sup>4</sup> cm<sup>-1</sup>) at photon energies of 1.8 eV or higher (Birkmire R. and Eser E., 1997). Up to date the highest conversion efficiency achieved for CdTe solar cells is 16.5% (Wu X. et al., 2001). CdTe solar cells are p-n heterojunction devices in which a thin film of CdS forms the n-type window layer. As in the case of Cu(In,Ga)Se<sub>2</sub>-based devices the depletion field is mostly in the CdTe. There are several deposition techniques to grow the CdTe like, physical vapor deposition, vapor transport deposition, close spaced sublimation, sputter deposition and electrodeposition (McCandless Brian E. and Sites James R., 2003). In this case, the close spaced sublimation has been selected to prepare the CdTe films for solar cell applications.

The sublimation technique for the deposition of semiconducting thin films of the II-VI group, particularly CdTe, has proven to be effective to obtain polycrystalline materials with very good optical and electrical properties. There are several steps that involve the formation of the deposited materials, these are listed as follows: 1) synthesis of the material to be deposited through the phase transition from solid or liquid to the vapor phase 2) vapor transport between the evaporation source and the substrate, where the material will be deposited in the form of thin film, and 3) vapor and gas condensation on the substrate, followed by the nucleation and grow of the films. In general, and particularly in our CdTe - case, the vapor transport is regulated by a diffusion gas model. This technique has several advantages over others because is inexpensive, has high growth rates, and it can be scaled up to large areas for mass production. The Close Spaced Vapor Transport technique, named as “CSVT”, is a variant of the sublimation technique, it uses two graphite blocks, where independent high electrical currents flow and due to the dissipation effect of the electrical energy by Joule’s heat makes the temperature in each graphite block to rise. One of the graphite blocks is named the source

block and the other is the substrate block. Figure 11 shows the block diagram of the CSVT system used to prepare the CdTe thin films. Between the source graphite block “A” and the substrate graphite block “B” is located the graphite boat that contains the material to be sublimated, and on top of this boat the substrate is located, in a very close proximity or close spaced. The material growth is carried out under the presence of an inert atmosphere like argon, nitrogen, etc. The growth rate of the material to be deposited can be controlled by controlling the pressure and gas flow rate. Also this inert gas can be mixed with a reactive gas like oxygen, which benefits the growth of CdTe with the characteristic p-type conductivity. The deposition parameters for this technique are: a)  $T_s$ : temperature of the source, b)  $T_{sub}$ : substrate temperature, it has to be lower than the  $T_s$  in order to avoid the re-sublimation of the material, c)  $d_{s-sub}$ : distance between the material to be deposited and the substrate and d)  $P_g$ : pressure of the inert gas inside the chamber.

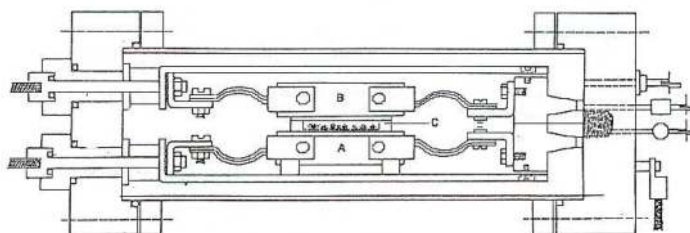

Fig. 11. Schematic diagram of a CSVT system

For the processing of CdTe thin film solar cells, it is necessary to use a *superstrate* structure, so that the CdS is deposited on  $\text{SnO}_2:F$ , in such a way that the growth process allows the film to be deposited over the whole surface, becoming a surface free of holes and caverns without empty spaces among the grains, and with a uniform grain size distribution. It is also required that the CdS layer matches well with the CdTe host, thus favoring a good growing kinetics for CdTe, as well as the formation of the  $\text{CdS}_x\text{Te}_{1-x}$  ternary compound in the interface due to the diffusion of S from CdS to CdTe. The high-efficiency CdTe solar cells to date have essentially the same *superstrate* structure. The superstrate structure is composed of a sodalime glass substrate, coated with a  $\text{SnO}_2:F$ ; a transparent conductor oxide as the front contact, then a CdS layer is chemically bath deposited, followed by the deposition of a CdTe layer and finally the deposition of two layers of Cu and Au to form the back contact to complete the CdS/CdTe device. In order to achieve solar cells with high conversion efficiencies, the physical and chemical properties of each layer must be optimized (Morales-Acevedo A., 2006). The deposition of CdTe was performed by using CdTe powder 99.999% purity. The deposition atmosphere was a mixture of Ar and  $\text{O}_2$ , with equal partial pressures of  $\text{O}_2$  and Ar. In all cases the total pressure was 0.1 Torr. Prior to all depositions the system was pumped to  $8 \times 10^{-6}$  Torr as the base pressure. In the CSVT-HW (hot wall) deposition, the separation between source and substrate was about 1 mm. The deposition time was 3 min for all the samples deposited with substrate and source temperatures of 550 °C and 650 °C, respectively. Under these conditions, CdTe layers of 2 – 4  $\mu\text{m}$  were obtained. The CdTe thin films were also thermally treated with  $\text{CdCl}_2$ . As discussed before, a very important treatment independently of the deposition technique for both CdS and CdTe layers is a thermal annealing after the deposition of  $\text{CdCl}_2$  on top of the CdTe layer. If the  $\text{CdCl}_2$

treatment is not performed, the short circuit current density and the efficiency of the solar cell are very low. This treatment consists in depositing 300–400 nm of CdCl<sub>2</sub> on top of CdTe with a subsequent annealing at 400 °C during 15–20 min in air, or in an inert gas atmosphere like Ar. During this process the small CdTe grains are put in vapor phase and re-crystallize, giving a better-organized CdTe matrix. The presence of Cl<sub>2</sub> could favor the CdTe grain growth by means of a local vapor phase transport. In this way the small grains disappear and the CdS/CdTe interface is reorganized.

## 5. Processing of Cu(In,Ga)Se<sub>2</sub> and CdTe thin films into solar cells

Cu(In,Ga)Se<sub>2</sub> and CdTe PV devices are obtained by forming p-n heterojunctions with thin films of CdS. In this type of structure, n-type CdS, which has a band gap of 2.4 eV, not only forms the p-n junction with p-type CuInSe<sub>2</sub> or p-type CdTe but also serves as a window layer that lets light through with relatively small absorption. Also, because the carrier density in CdS is much larger than in CuInSe<sub>2</sub> or CdTe, the depletion field is entirely in the absorber film where electron-hole pairs are generated (Birkmire and Eser, 1997). After solar cell completion the photovoltaic parameters like  $I_{sc}$ ,  $V_{oc}$ , FF and conversion efficiency were tested by doing the I-V characterization for the two structures; CdTe and Cu(In,Ga)Se<sub>2</sub>. All the parameters were measured under AM1.5 illumination.

### 5.1 Cu(In,Ga)Se<sub>2</sub>/CdS thin film solar cells

The substrate structure of a Cu(In,Ga)Se<sub>2</sub> thin film based solar cell is composed of a soda lime glass substrate, coated with a sputtered ~ 0.7 – 1 μm Mo layer as the back contact. After the thermal co-evaporation of Cu(InGa)Se<sub>2</sub> deposition, the junction is formed by chemically bath depositing the CdS with thickness ~ 30 - 50 nm. Then a high-resistance (HR) ZnO layer and a doped high-conductivity ZnO:Al layer are subsequently deposited, usually using the sputtering technique. Finally, the deposition of a current-collecting grid of Ni/Al completes the device as shown in figure 12. The total cell area is defined by removing the layers on top of the Mo outside the cell area by mechanical scribing.

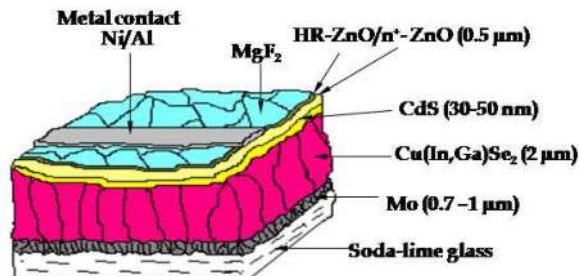

Fig. 12. Schematic configuration of a typical Cu(In,Ga)Se<sub>2</sub> thin film solar cell

#### 5.1.1 Discussion on the Cu(In,Ga)Se<sub>2</sub> thin film based solar cells results

Two Cu(In,Ga)Se<sub>2</sub> samples were used to be processed into solar cell devices: sample JS17 had a CdS layer prepared with a recipe based on CdCl<sub>2</sub> and sample JS18 with a recipe based on CdSO<sub>4</sub> as the Cd source. The *J-V* parameters for devices JS17 are: area = 0.47 cm<sup>2</sup>,  $V_{oc}$  = 536 mV,  $J_{sc}$  = 31.70 mA/cm<sup>2</sup>, fill factor = 64.0 %, and  $\eta$  = 10.9 % (see figure 13) and for JS18 are: area

$= 0.47 \text{ cm}^2$ ,  $V_{oc} = 558 \text{ mV}$ ,  $J_{sc} = 29.90 \text{ mA/cm}^2$ , fill factor = 63.1 %, and  $\eta = 10.5 \%$  (see figure 14). From these results, we can see that sample JS17 shows a conversion efficiency a little bit higher than JS18, this is due to the different recipe used to prepare the CdS layer as it was mentioned before. This was the only difference between the two devices, everything else was the same. From these figures, a low  $V_{oc}$  is observed, but we should expect to have a higher  $V_{oc}$  value, compared to the Ga content. The roll-over in forward bias could be indicative of a low sodium content in the  $\text{Cu(In,Ga)Se}_2$  films. Also, the low current collection, observed for the  $\text{Cu(In,Ga)Se}_2$  thin film devices, may be due to incomplete processing of the absorber layer. Improvements in device performance are expected with optimization of absorber processing.

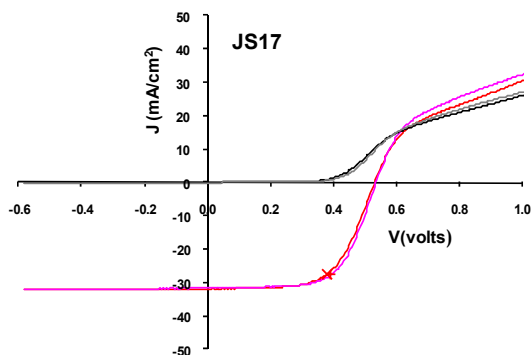

Fig. 13. J-V curves for the best  $\text{Cu(In,Ga)Se}_2$  thin film device prepared with a CdS bath solution based on  $\text{CdCl}_2$

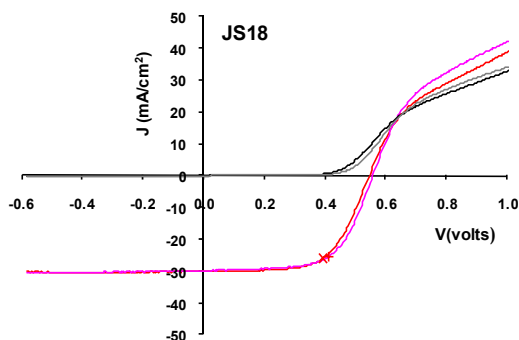

Fig. 14. J-V curves for the best  $\text{Cu(In,Ga)Se}_2$  thin film device prepared with a CdS bath solution based on  $\text{CdSO}_4$

## 5.2 CdTe/CdS thin film solar cells

The typical superstrate structure of a hetero-junction CdTe/CdS solar cell is composed of a soda lime glass substrate, coated with a sputtered transparent conducting oxide (TCO) to the visible radiation, which acts as the front contact, then a CdS layer with a thickness  $\sim 120 \text{ nm}$  is chemically bath deposited, followed by the deposition of the absorber CdTe layer by close spaced vapor transport technique and finally the CdS/CdTe device is completed by depositing the ohmic back contact on top of the CdTe layer, see figure 15. For the back contact,

two layers of Cu and Au (2nm and 350 nm, respectively) were evaporated, with an area of 0.08 cm<sup>2</sup>, onto the CdTe and annealed at 180 °C in Ar. The front contact was taken from the conducting glass substrate (0.5 μm thick SnO<sub>2</sub>:F/ glass with sheet resistivity of 10 Ω/□).

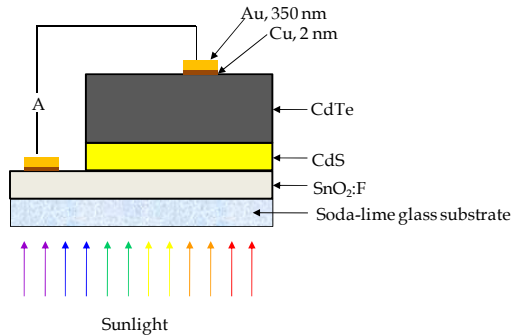

Fig. 15. Schematic configuration of a typical CdTe based solar cell

**5.2.1 Variation of the S/Cd ratio in the solution for deposition of CdS by chemical bath and its effect on the efficiency of CdS/CdTe solar cells**

The variation of the S/Cd ratio in the solution used in the preparation of the CdS films modifies the morphology, the deposition rate, the crystal grain size, the resistivity and the optical transmittance of these films and have an influence upon the structural and electrical properties of the CdTe layer itself, in addition to modifications of the CdS–CdTe interface. Hence, our study shows the influence of the S/Cd ratio in the solution for CdS thin films prepared by chemical bath upon the characteristics of CdS/CdTe solar cells with a superstrate structure (Vigil-Galán, et al., 2005).

The concentrations of NH<sub>3</sub>, NH<sub>4</sub>Cl and CdCl<sub>2</sub> were kept constant in every experiment, but the thiourea [CS(NH<sub>2</sub>)<sub>2</sub>] concentration was varied in order to obtain different S/Cd relations (*R<sub>tc</sub>*) in the solution. All the films were grown on SnO<sub>2</sub>:F conducting glasses (10 ohm-cm) at 75 °C. Deposition times were also varied, according to our previous knowledge of the growth kinetics (Vigil O. et al., 2001), with the purpose of obtaining films with similar thickness in all cases. The selected thiourea concentrations and deposition times for each S/Cd relation are shown in table 2.

S/Cd ratio <i>R<sub>tc</sub></i>	Thiourea concentration in the bath (mol/l)	Deposition time (min)
1	2.4 × 10 <sup>-3</sup>	120
2.5	6 × 10 <sup>-2</sup>	100
5	1.2 × 10 <sup>-2</sup>	120
10	2.4 × 10 <sup>-2</sup>	120

Table 2. Thiourea concentration and deposition time for each S/Cd relation

Solar cells were prepared by depositing CdTe thin films on the SnO<sub>2</sub>:F/CBD–CdS substrates by CSVT–HW. The atmosphere used during the CdTe was a mixture of Ar and O<sub>2</sub>, with an O<sub>2</sub> partial pressure of 50%. In all cases, the total pressure was 0.1 Torr. Prior to deposition the system was pumped to 8 × 10<sup>-6</sup> Torr as the base pressure. CSVT–HW deposition of CdTe

was done by placing a CdTe graphite source block in close proximity (1 mm) to the substrate block. The deposition time was 3 min for all the samples deposited with substrate and source temperatures of 550 °C and 650 °C, respectively. Under these conditions, CdTe layers of approximately 3.5  $\mu\text{m}$  were obtained. The CdTe thin films were coated with a 200 nm CdCl<sub>2</sub> layer and then annealed at 400 °C for 30 min in air. For the back contact, two layers of Cu and Au (2 nm and 350 nm, respectively) were evaporated, with an area of 0.08 cm<sup>2</sup>, on the CdTe film and annealed at 180 °C in Ar. The growth conditions of CdTe were maintained constant for all solar cells.

### 5.2.2 Discussion on CdTe thin film solar cells results

Figure 16 shows the set of *I-V* characteristics for CdS/CdTe solar cells made with the same  $R_{\text{tc}}$  (S/Cd ratio = 5). According to our experimental conditions, the solar cells made with the same technological process have similar characteristics.

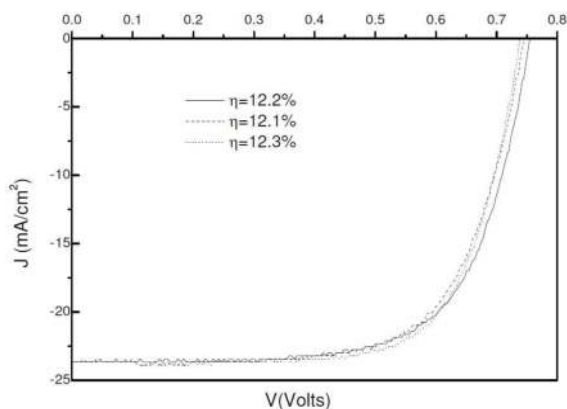

Fig. 16. *J-V* characteristics of three CdS/CdTe solar cells made with CdS layers grown with  $R_{\text{tc}} = 5$  during the CBD-CdS growth process

The *I-V* characteristics of CdS/CdTe solar cells under AM1.5 illumination (normalized to 100 mW cm<sup>-2</sup>) as a function of  $R_{\text{tc}}$  are shown in figure 17. In table 3, the average shunt ( $R_p$ ) and series ( $R_s$ ) resistances, the short circuit current density ( $J_{\text{sc}}$ ), the open circuit voltage ( $V_{\text{oc}}$ ), the fill factor (FF) and the efficiency ( $\eta$ ) of solar cells prepared with different  $R_{\text{tc}}$  are reported. The averages were taken from four samples for each  $R_{\text{tc}}$ . As can be seen in table 3,  $\eta$  increases with  $R_{\text{tc}}$  up to  $R_{\text{tc}} = 5$  and drops for  $R_{\text{tc}} = 10$ .

S/Cd ratio $R_{\text{tc}}$	$R_s$ (ohm-cm <sup>2</sup> )	$R_p$ (ohm-cm <sup>2</sup> )	$J_{\text{sc}}$ (mA/cm <sup>2</sup> )	$V_{\text{oc}}$ (mV)	FF (%)	$\eta$ (%)
1	6.8	318	20.8	617	55.2	7.1
2.5	5.4	800	21.8	690	55.5	8.3
5	2.9	787	23.8	740	70.5	12.3
10	5.9	135	22.7	435	52	5.4

Table 3. Photovoltaic parameter results for CdS/CdTe solar cells with different S/Cd ratio ( $R_{\text{tc}}$ ) in the CdS bath

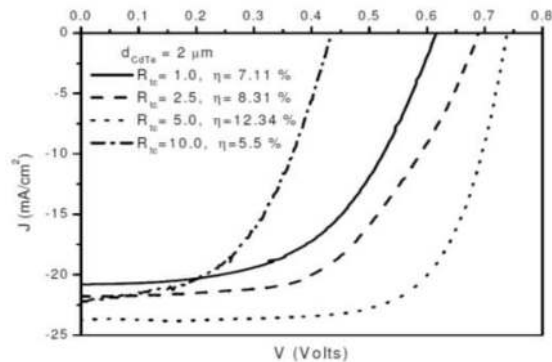

Fig. 17. Typical  $J - V$  characteristics of CdS/CdTe solar cells under illumination at  $100 \text{ mW cm}^{-2}$ , with  $R_{tc}$  as a parameter

There are several factors directly or indirectly influencing the cell behaviour, in particular the amount of S in the CBD CdS layers may influence the formation of the CdS<sub>1-x</sub>Te<sub>x</sub> ternary compound at the CdS-CdTe interface. CdTe films grown at high temperatures, such as those produced by CSVT, produce a sulfur enriched region due to S diffusion. The amount of S penetrating the bulk of CdTe from the grain boundary must be dictated by the bulk diffusion coefficient of S in CdTe and of course by the amount of S available in the CdS films. The re-crystallization of CdTe could be affected by the morphological properties of the CdS layers grown with different S/Cd ratios. These facts have been studied by Lane (Lane D. W. et al., 2003) and Cousins (Cousins M. A. et al. 2003). From this point of view the formation of CdS<sub>1-x</sub>Te<sub>x</sub> may be favored when the  $R_{tc}$  is increased in the bath solution. This ternary compound at the interface may cause a lower lattice mismatch between CdS and CdTe, and therefore a lower density of states at the CdTe interface region will be obtained, causing a lower value for the dark saturation current density  $J_0$ . The resistivity of the CdS and CdTe layers and their variation under illumination also change the characteristics of the cell under dark and illumination conditions. In other words, a better photoconductivity implies smaller resistivity values under illumination, with the possible improvement of the solar cell properties. In addition, optical transmittance, thickness and morphological measurements of the CBD-CdS films showed the following characteristics when increasing  $R_{tc}$ : i) band gap values are observed to increase (from 2.45 eV to 2.52 eV when changing  $R_{tc}$  from 1 to 10), ii) grain sizes become smaller (from 55.4 nm to 47.2 nm when S/Cd = 1 and 10, respectively) and iii) the average optical transmission above threshold increases from 68% to 72% when  $R_{tc}$  is increased from 1 to 10. Higher band-gap values of the window material improve the short circuit current density of the solar cells. Thin films with smaller grain sizes show fewer pinholes with a positive effect on the open circuit voltage and fill factor. In this regard, the properties of the CdS layers are correlated with the kinetic of the deposition process when the concentration of thiourea is changed. For instance, for high thiourea concentration, the reaction rate becomes large enough to promote a quick CdS precipitation which leads to the formation of agglomerates in the solution rather than nucleation on the substrate surface, while for low thiourea concentration a very slow growth process can be expected, leading to a thinner but more homogeneous layer.

## 6. Conclusions

We have found that CBD-CdS thin films grown under different conditions, like monolayers or bi-layers, using a standard bath configuration or a modified configuration, the principle for the deposition process is the same: a common precipitation reaction. Depending of the regime we decide to choose, we must perform an optimization of the deposition parameters in order to get the CdS film with the best physical and chemical properties. The quality of the CdS window partner and the absorber material like CdTe and Cu(In,Ga)Se<sub>2</sub> will have a great impact on the conversion efficiencies when applied into thin film solar cells.

## 7. Acknowledgements

The authors would like to thank to Bill Shafarman from University of Delaware for device processing and characterization. This work was partially supported by CONACYT, grant 47587, ICyT-DF, grant PICS08-54 and PROMEP, grant 103.5/10/4959.

## 8. References

- Birkmire R. and Eser E. (1997), *Annu. Rev. Mater. Sci.*, 27:625–53.
- Boyd D, Thompson D, Kirk-Othmer, (1980), *Encyclopaedia of Chemical Technology*, Vol. 11, 3rd Edition, 807–880, John Wiley.
- Contreras-Puente G., Tufino-Velazquez M., Calixto M. Estela, Jimenez-Escamilla M., Vigil-Galan O., Arias-Carbajal A., Morales-Acevedo A., Aguilar-Hernandez J., Sastre-Hernandez J., Arellano-Guerrero F.N. (2006), *Photovoltaic Energy Conversion, Conference Record of the 2006 IEEE 4th World Conference*.
- Cousins M. A., Lane D. W., and Rogers K. D. (2003). *Thin Solid Films* 431–432, 78.
- Lane D. W., Painter J. D., Cousins M. A., Conibeer G. L., and Rogers K. D. (2003). *Thin Solid Films* 431–432, 73.
- McCandless Brian E. and Sites James R., (2003), *Cadmium Telluride Solar Cells*, in: *Handbook of Photovoltaic Science and Engineering*, Luque A. and Hegedus S., pp. 567 – 616, John Wiley & Sons, Ltd ISBN: 0-471-49196-9, West Sussex, England.
- Mitchell K. et al., (1990), *IEEE Trans. Electron. Devices* 37, 410–417.
- Morales-Acevedo A. (2006). *Solar Energy* 80, 675.
- Repins I. et al., (2008), *Prog. in Photov: Research and Applications* 16, 235.
- Rocheleau R, Meakin J, Birkmire R, (1987), *Proc. 19th IEEE Photovoltaic Specialist Conf.*, 972–976.
- Romeo N., Bosio A., Canevari V. and Podestà A. (2004), *Solar Energy*, Volume 77, Issue 6, Pages 795–801.
- Shafarman W. N. and Stolt L. (2003), *Cu(InGa)Se<sub>2</sub> Solar Cells*, in: *Handbook of Photovoltaic Science and Engineering*, Luque A. and Hegedus S., pp. 567 – 616, John Wiley & Sons, Ltd ISBN: 0-471-49196-9, West Sussex, England.
- Schon, J. H., Schenker, O. and Batlogg, B. (2001), *Thin Solid Films* 385, p.271.
- Vigil-Galan O., Arias-Carbajal A., Mendoza-Perez R., Santana-Rodríguez G., Sastre-Hernandez J., Alonso J. C., Moreno-Garcia E., Contreras-Puente G. and Morales-Acevedo A. (2005), *Semiconductor Science and Technology* 20, 819.
- Vigil O., Arias-Carbajal A., Cruz F., Contreras-Puente G., and Zelaya-Angel O. (2001). *Mats. Res. Bull.* 36, 521.
- Wu X. et al., (2001), *Proc. 17th European Photovoltaic Solar Energy Conf.* 995.



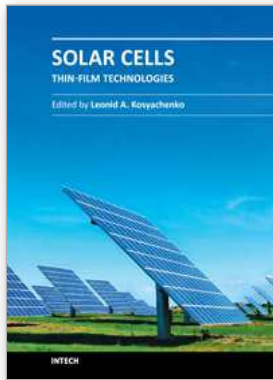

## **Solar Cells - Thin-Film Technologies**

Edited by Prof. Leonid A. Kosyachenko

ISBN 978-953-307-570-9

Hard cover, 456 pages

**Publisher** InTech

**Published online** 02, November, 2011

**Published in print edition** November, 2011

The first book of this four-volume edition is dedicated to one of the most promising areas of photovoltaics, which has already reached a large-scale production of the second-generation thin-film solar modules and has resulted in building the powerful solar plants in several countries around the world. Thin-film technologies using direct-gap semiconductors such as CIGS and CdTe offer the lowest manufacturing costs and are becoming more prevalent in the industry allowing to improve manufacturability of the production at significantly larger scales than for wafer or ribbon Si modules. It is only a matter of time before thin films like CIGS and CdTe will replace wafer-based silicon solar cells as the dominant photovoltaic technology. Photoelectric efficiency of thin-film solar modules is still far from the theoretical limit. The scientific and technological problems of increasing this key parameter of the solar cell are discussed in several chapters of this volume.

### **How to reference**

In order to correctly reference this scholarly work, feel free to copy and paste the following:

M. Estela Calixto, M. L. Albor-Aguilera, M. Tufiño-Velázquez, G. Contreras-Puente and A. Morales-Acevedo (2011). Chemical Bath Deposited CdS for CdTe and Cu(In,Ga)Se<sub>2</sub> Thin Film Solar Cells Processing, Solar Cells - Thin-Film Technologies, Prof. Leonid A. Kosyachenko (Ed.), ISBN: 978-953-307-570-9, InTech, Available from: <http://www.intechopen.com/books/solar-cells-thin-film-technologies/chemical-bath-deposited-cds-for-cdte-and-cu-in-ga-se2-thin-film-solar-cells-processing>

# **INTECH**

open science | open minds

### **InTech Europe**

University Campus STeP Ri  
Slavka Krautzeka 83/A  
51000 Rijeka, Croatia  
Phone: +385 (51) 770 447  
Fax: +385 (51) 686 166  
[www.intechopen.com](http://www.intechopen.com)

### **InTech China**

Unit 405, Office Block, Hotel Equatorial Shanghai  
No.65, Yan An Road (West), Shanghai, 200040, China  
中国上海市延安西路65号上海国际贵都大饭店办公楼405单元  
Phone: +86-21-62489820  
Fax: +86-21-62489821

© 2011 The Author(s). Licensee IntechOpen. This is an open access article distributed under the terms of the [Creative Commons Attribution 3.0 License](#), which permits unrestricted use, distribution, and reproduction in any medium, provided the original work is properly cited.