

Engineering Better Electric-Powered Wheelchairs To Enhance Rehabilitative and Assistive Needs of Disabled and Aged Populations

Yen Kheng Tan and Sangit Sasidhar
*National University of Singapore
Singapore*

1. Introduction

All around the world, the age distribution of the world population is shifting towards older ages, causing an increase in the world population's mean or median age. The corresponding figures for the world population's mean age as a whole are 23.9 for 1950, 26.8 for 2000, and 37.8 for 2050 (United Nations, 2004). The growing trend of the world population's mean age is largely due to the decline in the fraction of the population composed of children (declining fertility) and the rise in the fraction of the population that is elderly (due to longer life expectancy). The impact of population ageing on developed countries with strong economy strongholds, such as United States of America (USA) and Japan, is even more severe. To a certain extent, Singapore, serving as a Southeast Asia's financial and high-tech hub, is also affected as well. Population ageing has major consequences and implications in all areas of our daily life as well as other important aspects such as economic growth, savings, investment and consumption, labour markets, pensions, property and care from one generation to another. Additionally, health and related care, family composition and life-style, housing and migration are also affected.

According to a published report titled "Singapore's population ageing" (CAI, 2006), it is found that the number of seniors will increase from 8.4% in 2005 to 18.7% in 2030 as illustrated in Chart.1. In absolute terms, seniors will increase from about 296,900 in June 2005 to 873,300 in 2030. The report continues to elaborate that "the first batch of post-war baby boomers will reach 65 years of age by 2012. Today, one out of every twelve Singaporeans is aged 65 or above. By 2030, this ratio will become one out of five". These figures indicate that our ageing population in Singapore is escalating at a fast rate. Other than the aged population issue, the numbers of disabled people with mobility difficulties are expected to increase over the years. Mr. Heng Chee How, Minister of State for National Development and Mayor of Central Singapore District, backs up this statement for Singapore context and he believes that the key driving forces behind this expected increase are, "the proportion of a growing population who use the wheelchair as a result of medical conditions and accidents and the rate of ageing of the population itself." Similarly, in

worldwide context, an estimated 100-130 million people with disabilities need wheelchairs. Experts predict that the number of people who need wheelchairs will increase by 22 percent over the next ten years (R.A. Cooper & R. Cooper, 2003). Due to the increasing population of mobility impaired people in the world, there is an overwhelming need for wheelchairs and the research and development required to make these wheelchairs safer, cheaper, more comfortable and effective and widely available.

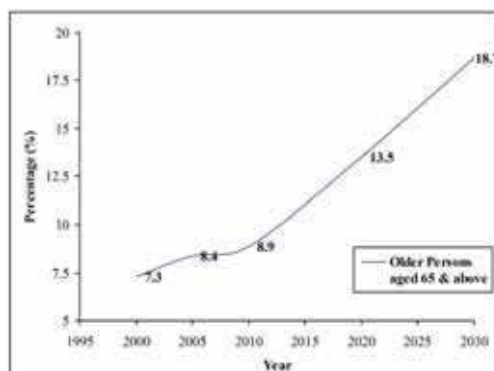

Fig. 1. Proportion of Resident Population Aged 65 & Over From 2000 – 2030

Source: Singapore Department of Statistics (DOS), 2005

Some advanced technologies can be explored for engineering better wheelchairs to enhance the rehabilitative and assistive needs of the disabled and aged populations. Assistive technology (AT) is defined as any technology that is developed to assist people with disability or old age to perform tasks that are too difficult for them to complete. It promotes greater independence for people with disabilities by enabling them to perform tasks that they are formerly unable to accomplish, or has great difficulty accomplishing, by providing enhancements to or changed methods of interacting with the technology needed to accomplish such tasks. By doing so, the daily needs of the disabled and aged populations can be better taken care of without any extra assistance. As mentioned earlier, the aged and disabled populations are rising at a fast pace, hence a lot of research efforts have been poured into the AT field. Many researchers are devoting their time and attention on AT research work so as to improve the lifestyle of the aged and disabled peoples (Cooper et al., 2008).

Wheelchair technology is one of the most favourable technologies to be investigated because the demand for electric powered wheelchairs has been increasing very rapidly due to ageing populations. The introduction of wheelchairs allows individuals to complete daily tasks with greater independence and to access school, work, and community environments. More individuals are able to benefit from the new options and sophisticated wheelchair-related technologies. For examples, Nanyang Technological University (NTU) in Singapore has developed a wheelchair with wheelchair gap enabler, which allows wheelchair users to board a bus faster and easier and also clear low steps, such as roadside curbs, with ease and efficiency. The iBOT developed in USA can engage four-wheel drive to maneuver rough terrain, go up slopes, or climb 4-inch curbs. These improvements have given great helps to the disabled people sitting in the wheelchairs to overcome many difficulties. Since

wheelchairs have been in use for several hundred years, it is going to continue to evolve in their design and use; much remains to be learned about optimum design and safe use of wheelchairs (Cooper et al., 2006).

Electric-powered wheelchairs (EPWs) have gained increasing popularity among the disabled as well as aged populations because they provide functional mobility for people with both lower and upper extremity impairments. They are becoming increasingly important as more users transition from manual mobility to powered mobility. This shift is especially true for individuals with progressive conditions and people with high levels of impairment (Cooper, 1998). Advances have been made in the design of EPWs over the past 20 years, yet there are some aspects in these wheelchairs which have not improved substantially since the early 1980s. These include adequate mobility and comfort with enhanced control methods (Ding & Cooper, 2005), proper leg and foot support (Lei et al., 2005), advanced maneuver and navigation techniques (Aissaoui et al., 2000).

In this chapter, the three main features to be incorporated onto electric-powered wheelchair are discussed. These features include 1) voice-activated control and closed-loop current control for electric-powered wheelchair, 2) personal navigation system based on wireless sensor network and 3) motorized foot rest which give a way of mobility for handicapped and elderly people to move around in indoor condition easily and to perform rehabilitative excercises without being dependent on someone else.

2. Existing Electric-Powered Wheelchair Technology

Electric-powered wheelchairs available in the market provide much functionality for the user and are composed of many different sub-systems. Each of these sub-systems and their functions can be tailor made for catering to a specific target user group.

The basic system of a wheelchair is the drive system which usually consists of a two wheel drive type or a four wheel drive type. The mid wheel drive power wheelchair is maneuverable in small spaces and provides for a tighter turning radius but the wheelchair may get stuck on uneven terrain. The front wheel drive system is very stable for uneven terrain and for inclined mobility but they are slower as compared to the rear wheel drive system. The most common type is the rear-wheel drive wheelchairs. The chair is stable and can achieve high speeds. The only drawback of this system is the large turning radius of the wheelchair (Ding & Cooper, 2005). External all-terrain wheelchairs typically use the four wheel drive system as they are easier to maneuver and control. Wheelchairs with special functions such as stair climbing or dynamically balance function use a wheel-cluster system (Ding & Cooper, 2005). Stair climbing is done by balancing the centre of gravity of the chair between the front and the rear wheels at all times. Dynamically balancing the wheelchair on two wheels, mimicking the human balance model, enables the user to move around at eye level. Our system uses a rear wheel drive system as the stability of the wheelchair is an important criterion when designing for elderly users or for users with limb disabilities.

Portable power is an important aspect of the wheelchair. The study by Beno et al. (2002) explores the feasibility of flywheel batteries for vehicles in general. Another study by Cooper & Tai (1998) discusses the feasibility of flywheel batteries for electric-powered wheelchairs and explores the safety issues such as fragmentation failure or touch-down failures of the flywheel. Typically, electric powered wheelchairs use chemical batteries as their energy source but it makes the wheelchair bulkier and difficult to transport.

There are many ways for the user to input information into the wheelchair control system. The joystick is the most commonly used mode of input for the wheelchair. Cooper et al. (2000) have designed an isometric joystick and compared its performance standards to a position sensing joystick while Diciano et al. (2007) developed a digital isometric joystick and studied the force applied by the user on an isometric joystick and motion sensing joystick. Jones et al. (1998) studied the performance of wheelchairs using a performance sensing joystick and a force sensing joystick. Oskoei & Hu (2008) propose a myoelectric based virtual joystick, which utilizes myoelectric signals from the forearm of the user to navigate the wheelchair. The advantage of this methodology is that users with severe motor disabilities find it easier to maneuver the wheelchair. Another mode of input for such users is voice recognition. The user trains the system to recognize simple commands such as "GO" or "STOP" and uses them for navigating the wheelchair. Pacnik et al. (2005) and Stanton et al. (1990) have both devised intelligent wheelchairs with voice recognition control. A combination of joystick input and voice recognition input is utilized in the wheelchair designed by us to help users with motor disabilities and to navigate in close-spaced environments.

A navigation system for wheelchairs would require the user not to worry about the path taken and concentrate only on commanding the wheelchair. The Brunel Navigation System for the Blind (BNSB) (Cecelja et al., 2006) is developed by integrating three main technologies: Global Positioning System (GPS), Geographical Information System (GIS) and Mobile Communication System (MCS). The BNSB uses GPS as the main navigational systems which operates in assisted GPS (AGPS) mode and fixes the users' position. The same system can be used for wheelchair users as well but implementing it in indoor environment may not be efficient. Wheelchair users in a fixed indoor environment like a shopping centre or the user's house would benefit much with an indoor navigation system. The Power-Line Positioning (PLP) Indoor Location System (Patel et al., 2006) uses the residential powerline for finding the location of the user. The PLP uses fingerprinting of tone detectors in different parts of the house and the room to localize them and find their location. Use of Wireless Sensor Networks for navigation has been done by (Lei et al., 2005) who have designed a wireless assisted pedestrian system using magnetic compass and accelerometers. Jirawimut et al. (2003) propose a method for dead reckoning correction in pedestrian navigation system while Usui et al. (2005) evaluate the position accuracy of pedestrian navigation systems using 3-dimensional maps in lieu of 2-dimensional maps. For us, wireless sensor network is used for the wheelchair navigation system in known indoor environments along with a digital compass for direction mapping.

Commercial foot rests available for wheelchairs are manual and they have very bare minimal functionalities. These conventional foot rests are manually adjustable to some preset heights and positions which are then locked at that position by an external locking mechanism. The problem with such conventional foot rest is that the old age or disabled user who is normally quite weak needs a lot of strength to lift up his/her legs onto the resting pad of foot rest. Another alternative is to ask someone besides the user to provide the assistance. Additionally, prolong sitting on the wheelchair causes a set of problems to the user as mentioned by Aissaoui et al. (2000). At present, there is next to negligible literature regarding the motorized foot rest and therefore the related work is presented in this chapter.

3. Microcontroller Based Voice-Activated Powered Wheelchair Control

This part of the chapter describes the design of a microcontroller based voice-activated powered wheelchair supplementary with joystick control. Most of the conventional electric powered wheelchairs use a joystick as a user input mode of control to maneuver the powered wheelchairs (Nisbet, 1996). The major drawback of joystick control is that users with upper limb disability would find it difficult to maneuver the wheelchair. Moreover, elderly users with weak and jerky hands would be more comfortable giving verbal instructions than navigating the wheelchair using a joystick. The proposed voice-activated powered wheelchair supplementary with joystick control would allow users with weak and disabled upper limb to maneuver the wheelchair easily without the need to use hands. Referring to Fig. 2, the electric powered wheelchair consists of three main building blocks viz. the user interface, the control system and the drive system.

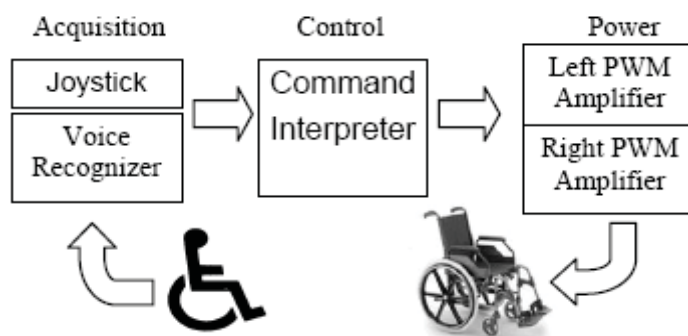

Fig. 2. Block Diagram of an Electric Powered Wheelchair

3.1 User Interface (Acquisition)

This electric-powered wheelchair is targeted for elderly users and users with disability hence, both joystick and voice recognition are used as user interface for acquisition. The supplementary joystick gives a better control of speed for better manoeuvring in confined areas. During the research work, a standard HFX magnetic joystick is used for joystick control. The joystick utilises Hall Effect Sensors to measure the physical movement of the joystick's handle. When the handle is moved, magnets attached to the shaft of the joystick (one for each axis) link the Hall Effect sensors causing a fluctuation in the magnetic field. This causes a voltage change that is interpreted by the integrated microcontroller. Both X and Y axes sensors are placed in series with a resistor and a fixed bias of 5 V is used to power the sensors, and the centre voltage output is 2.5V. The output voltage of the joystick can't be 0V or 5V due to additional resistance, but varies between 0.8V and 4.6V.

The voice processing module, as shown in Fig. 3, consists of a HM2007 voice recognition chip which processes the input voice signals fed through a microphone. The microphone is capable of noise cancellation and voice amplification. The voice recognition chip uses a supervised training method for classification. The voice chip is initially trained by the user. Once the system is programmed with the required commands, the chip operates in the hearing mode i.e. the chip listens continuously and tries to match the words spoken by the

user to the words programmed earlier. If there is a match, it sends an output corresponding to the match; otherwise the module continuously waits and keeps listening. The words recorded by the system are recognized by their frequencies, and different people speak may the same words at different frequencies. Hence, only the user's voice must be used for training the module. The accuracy rate and the ability to work even in noisy environment are very important for the safety and the ease of use of the wheelchair.

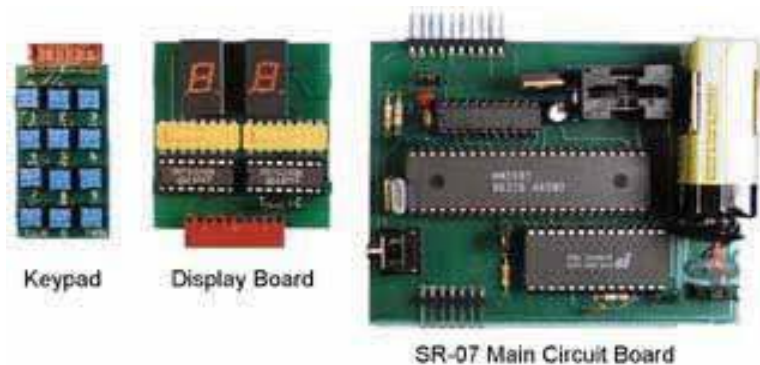

Fig. 3. Components of the SR-07 Voice Recognition Module

The user trains the chip using the included keypad. One of the keys is pressed and the voice command is spoken into the microphone clearly. For example, pressing the number of "01" would train the word number 01 and assign the voice command spoken to it. The LED in the main circuit board blinks off momentarily, signalling the successful acceptance of the word and the number used for this command is displayed. Further commands can be programmed in a similar way.

3.2 Control System

The microcontroller chosen for the implementation of the control system is an Infineon XC886 high performance 8-bit Microcontroller with on-chip flash memory for enhanced motor control. It has automatic code generation provided by the software DavE, and can be programmed using C programming language with Keil compiler and debugger. The microcontroller has several peripheral features required by the control of the power wheelchair, such as Capture/Compare Unit (CCU6) with two independent 16-bit timers dedicated for PWM generation for AC and DC motor control, providing 4 compare channels with 7 outputs, and 8-bit ADC with high accuracy, providing 8 channels, to convert the analog input signals to digital signals respectively.

There are two modes of control possible for the drive system viz. the open loop control and closed loop control. In open loop control as there is no feedback from the motor, the microcontroller will not be able to detect any increase or decrease in speed and take corrective action. This may result in a jerk effect that may cause discomfort to the wheelchair user. Providing a closed loop current control using a PI controller, as shown in Fig. 4, would ensure that any abrupt change in the load torque would not result in an abrupt change in the motor torque resulting in close to zero acceleration and negligible jerks during wheelchair operation.

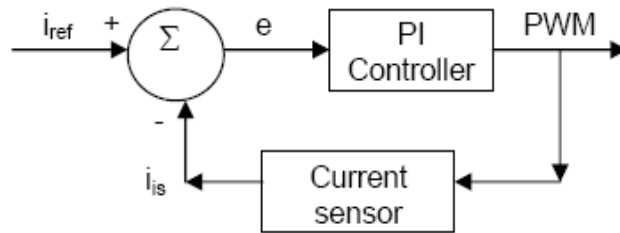

Fig. 4. Closed-Loop Feedback Current Control

The motor torque, T_{em} , is proportional to the armature current, I , across the motor.

$$T_{em} = k\phi I \quad (1)$$

$$T_{em} = T_l + J \frac{d\omega}{dt} \quad (2)$$

$$V = iR + k\phi\omega \quad (3)$$

If the current is controlled such that there are no sudden changes, then the motor torque, T_{em} , would also not have any sudden changes. The acceleration, $d\omega/dt$, of the motor is dependent on the difference between the motor torque, T_{em} , and the load torque, T_l . Since there is no abrupt change in the motor torque, the wheelchair moves at a constant speed with zero acceleration, hence there is no jerk at all. Hence a good control of current can lead to a much better performance of wheelchair. Furthermore, with the use of current sensor HXS 50-NP/SP2, it is possible to determine if the load current exceeds the current limit. With over current protection implemented, problems like overheating or damage of the motor are limited.

The microcontroller receives analog signals from the joystick, converts them to digital format and interprets and processes them. The voice recognition system processes the voice commands and sends the digitized signal to the microcontroller. The feedback from the current sensors is compared with the reference current and the speed of the motor is determined according to the error between the signals received from user interface and current sensors feedback. The microcontroller outputs the corresponding PWM signals to the motor drive circuit to drive the DC motor. The joystick control and the voice recognition control are further discussed below.

3.2.1 Joystick Control

The motion of wheelchair depends on the position of joystick. The duty cycle of PWM signals is generated according to the analog inputs from joystick, and the PWM signals determine the speed of the motors. The frequency of PWM operation is 20 kHz. The analog signal acquired from joystick is converted into digital format in the microcontroller which is used as the reference current signal for the closed-loop current control. X-axis and Y-axis of the joystick are used to describe the position of joystick knob. Different reference currents are assigned to each position. As shown in Fig. 5, the numbers (0 – 10) represent the strength of the reference current signal. The number on the left hand side indicates the left motor whereas the number on the right hand side indicates the right motor. If the reference

number is larger than 5, the motor rotates forward; when the given reference current number is less than 5 (0-4), the motor rotates in the reverse direction.

					10,10					
				9,10	9,9	10,9				
			8,10	8,9	8,8	9,8	10,8			
		7,10	7,9	7,8	7,7	8,7	9,7	10,7		
	6,10	6,9	6,8	6,7	6,6	7,6	8,6	9,6	10,6	
5,10	5,9	5,8	5,7	5,6	5,5	6,5	7,5	8,5	9,5	10,5
	4,8	4,7	4,6	4,5	4,4	5,4	6,4	7,4	8,4	
		3,6	3,5	3,4	3,3	4,3	5,3	6,3		
			2,4	2,3	2,2	3,2	4,2			
				1,2	1,1	2,1				
					0,0					

Fig. 5. Left and Right Motor Current Reference (I_{ref}) Distribution over Joystick

3.2.2 Voice Recognition Control

The control signal flow diagram of the voice recognition circuit is illustrated in Fig.6. The voice recognition circuit is continually listening. When repeating a trained word into the microphone, the number of the word is displayed. For instance if the word "GO" was trained as word number 01, when saying the word "GO" into the microphone, the number 01 would be displayed. This number is sent to the microcontroller and logic corresponding to it would generate the appropriate duty cycle for PWM generation.

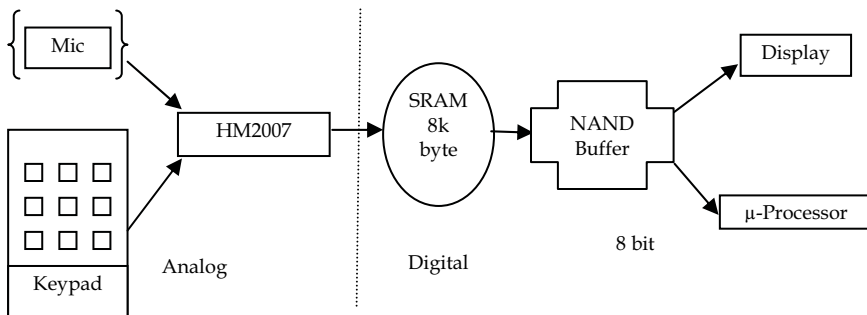

Fig. 6. Signal Flow Diagram of the Voice Recognition Control

The current sensor feedback signal corresponding to the load current drawn by the motor is first checked to see if it is larger than the preset current limit. This is the over-current protection feature. If the load current is within the normal operating range, the feedback current is compared with reference current, generating an error signal. The error signal is then injected into the PI controller to generate the output PWM control signals.

3.3 Drive System

The wheelchair has 2 DC motors attached to each of the left and right wheels. By controlling the individual speeds of both motors, the motion, i.e. the speed and direction of the wheelchair can be controlled. For example, the wheelchair turns left if the right wheel rotates faster than the left wheel and vice versa. A DC chopper not only allows adjustable speed control, but it also eliminates discontinuous conduction mode and allows bi-directional rotation. It consists of an H-bridge circuit which allows the direction and speed of the motor to be controlled by the power semiconductor switches. The switches are required to withstand a high current drawn by the motor under load conditions. The PWM outputs to adjacent switches are complimentary to ensure that there is no shoot-through effect resulting in a short circuit of the power supply.

The drive system is made up of two high current PN half bridge (BTS7970B) devices which amplify the input PWM signals to drive the DC motor. The designed PCB drive circuit board can provide a maximum driving current of 37.5A. The control system provides the PWM output signals to the drive system based on the command input signals from the user on the wheelchair. The output voltages are determined by the PWM signals. Fig. 7 shows the PCB layout of the H-bridge and its associated electronic circuit designed for the wheelchair.

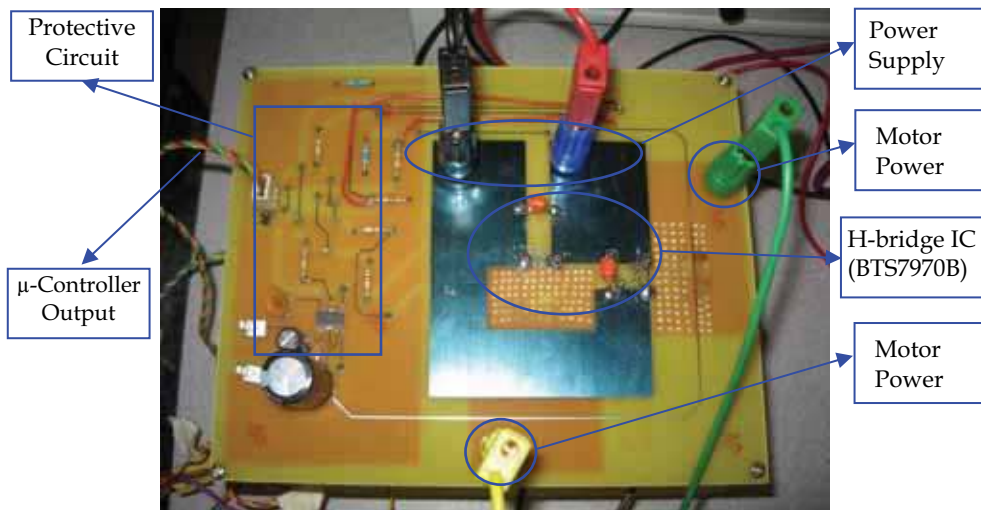

Fig. 7. PCB Layout of the H-bridge and its Associated Electronic Circuit

A 12V 36AH lead acid battery is used as the power supply for the electric-powered wheelchair. Lead acid battery is chosen over a flywheel battery as the wheelchair is designed for users with upper limb disability and elderly users and the risk of any damage due to the flywheel breaking or fragmenting is much higher (Cooper & Tai, 1998).

3.4 Prototype Wheelchair

Fig. 8 shows the schematic of the motor drive system and the control system of the prototype while Fig. 9 shows the prototype wheelchair.

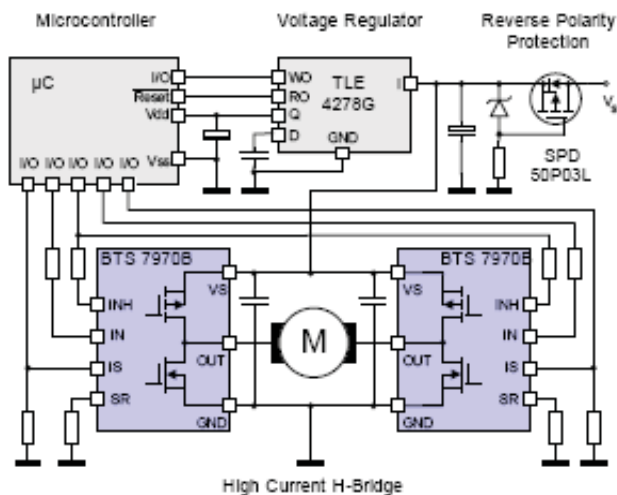

Fig. 8. Schematic Diagram of Prototype Motor Drives and Control System



Fig. 9. Prototype of Electric-Powered Wheelchair

The technical specifications of the wheelchair are given below:

Parameters	Value
Battery	12V , 36AH
Motor	24V DC
Charging Time	9 Hrs
Max. Driving Speed	Forward: 6.0Km/Hr Backward: 3.0Km/hr
Max. Weight Capacity	120 Kg
Total Weight of the Chair	77.29 Kg

Table 1. Technical Specifications of the Prototype

3.5 Experimental Results

The speed of the motor is determined by the voltage across the motor armature, as shown by equation (3), as the voltage drop across the armature resistance is negligible at steady state. To vary the voltage of the motor, a pulse width modulator (PWM) circuit is used. The PWM circuit varies the duty cycle of the output voltage and hence changes the average DC link voltage across the motor terminals.

The prototype electric-powered wheelchair has been tested with human load between 60 kg to 120 kg moving on a flat surface. The starting current of the DC motor is much higher than the rated full load current due to the negligible back emf across the motor armature. If the driver circuit is incapable of supporting the starting current it will fail, resulting in the breakdown of the whole system. The starting current drawn by the DC motor is observed to be about 20A. Our designed motor driver circuit board which can deliver up to 37.5A is able to meet this requirement. Fig. 10 shows the output voltage and the load current for a stationary wheelchair with a load of 100 kg. According to Fig. 5, the reference current for this joystick position is (5, 5) or a PWM duty cycle of 50% as evident from Fig. 10.

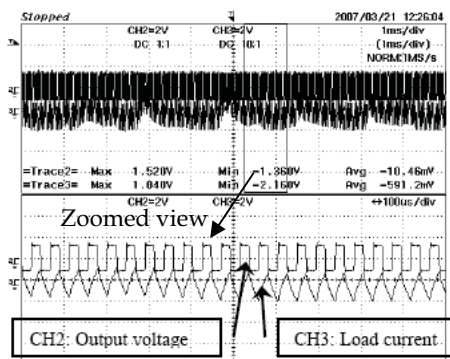

Fig. 10. Wheelchair in still position

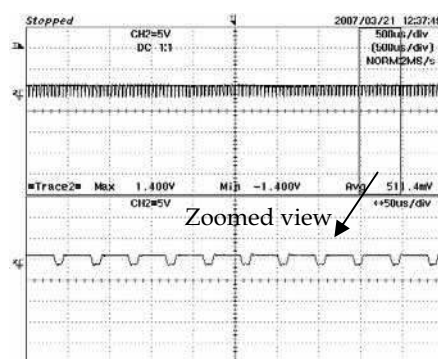

Fig. 11. Output Voltage in Steady State with Load for Forward Motion

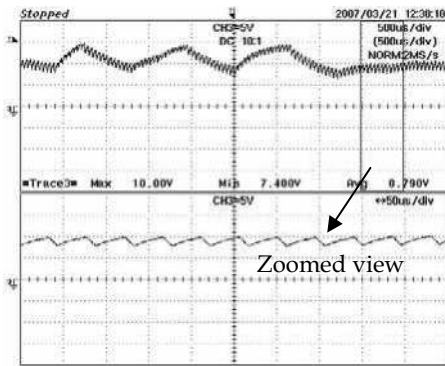

Fig. 12. Load Current in Steady State with Load for Forward Motion

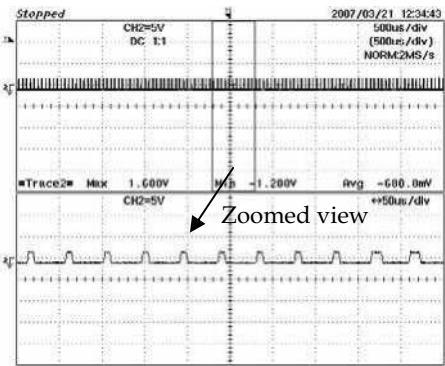

Fig. 13. Output Voltage in Steady State for Reverse Motion

From Fig. 12 it can be observed that the load current can be controlled to a certain level with stable performance. The fluctuating parts are due to the position change of the joystick, which is not fixed at one point due to manual control. Fig. 11 indicates the output voltage with a duty cycle of about 80% corresponding to a speed of 5 km/hr in the forward direction. Fig. 13 shows a PWM duty cycle of about 20% indicating reverse motion corresponding to a speed of 2.5 km/hr. The response time of the voice recognition system is calculated from Fig. 14 and Fig. 15 and is found out to be 672ms for the 'GO' command and 824ms for the 'STOP' command.

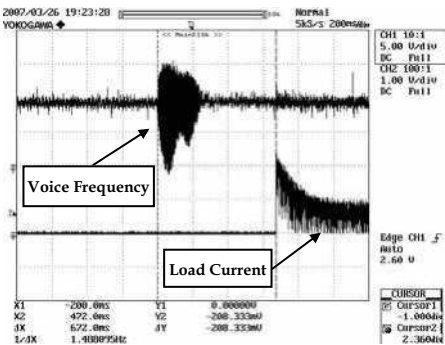

Fig. 14. Voice Frequency and Load Current with "GO" command

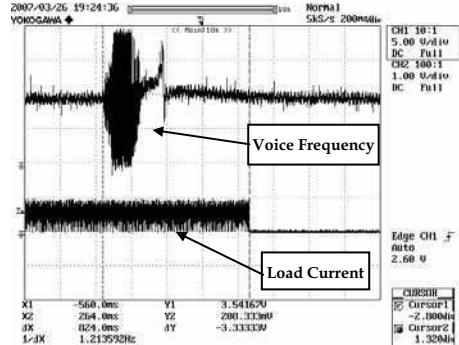

Fig. 15. Voice Frequency and Load Current with "STOP" command

This section of the chapter describes the design for a microcontroller based voice-activated powered wheelchair supplementary with joystick control. The voice recognition system helps the elderly users or users with upper limb disability in commanding the wheelchair. The next section deals with the design of a personal intelligent navigation system for known indoor environment using wireless sensor networks.

4. Personal Navigation System Based Wireless Sensor Network Technology

4.1 Introduction on Wireless Personal Navigation System

The objective of this section is to illustrate the development of a wireless indoor navigation system for the disabled and aged, particularly the wheelchair bounded, through the achievement of both location and direction determinations. A commonly used method of navigation for wheelchair patients in an indoor setting is the line tracking system, where light sensors are used to differentiate white and dark lines that are attached onto the ground surface. While this method has areas for further improvements (unsightly and inflexible navigation), hence a better wireless alternative is proposed in achieving the same motives. In recent years, the Global Positioning System (GPS) is widely used in many modern navigational applications. However, GPS technology is ineffective in indoor settings due to obstructions in buildings that hinder transmissions. Other possible location determining methods include using infrared, ultrasonic or radio signals and optical tracking systems.

A literature study was conducted to understand some of the research papers that were published regarding wireless indoor navigation systems. For instance, the Brunel Navigation System (Cecelja et al., 2006) for the Blind (BNSB) is developed by integrating three main technologies: Global Positioning System (GPS), Geographical Information System (GIS) and Mobile Communication System (MCS). The functional components of the BNSB are accommodated into two remotely linked terminals: Mobile Navigation Unit located at the remote site of the visually impaired pedestrian and the Navigation Service Centre, which is the sighted guide. The Mobile Navigation Unit is a wearable terminal that includes a digital video camera, a GPS receiver and a mobile network interface. A dead reckoning system, used to position the user when the GPS is not available, is also placed in the unit. The Navigation Service Centre is a stationary computer terminal running a GIS database and a display system to visualize video image and the user's location on a digital map. Navigation information includes real time transmission of the video image, GPS or dead reckoning positioning data and voice communication between the user and the guide. Another research area for indoor navigation systems is the Mobile Ad Hoc Network (MANET). MANET (Latiff et al., 2005) is a collection of wireless mobile nodes that cooperatively form a network without specific user administration or configuration. All nodes contribute and maintain connectivity in the network since all of them can both communicate and also relay packets to other nodes. When nodes move, the topology of the network also changes and hence previously computed routes to a specific node has to be recomputed. Nodes can either determine location either by itself or rely on other nodes. The self-positioning system uses at least three signal strength measurements extracted from messages that are being broadcast by pre-determined nodes at intervals. These pre-determined nodes, also termed anchor nodes (AN), are stationed strategically in order to be received by all mobile nodes in the network. Distance of the mobile node (MN) to the ANs will be determined from the signal strength received based on a propagation path loss model of the environment. If the distance and location of these ANs are known, mobile nodes can triangulate its coordinates. The system to be developed will not require additional hardware since it uses the existing wireless communication hardware which is based on IEEE 802.11b standards. Another special feature of this self-positioning system is that it does not use signals from GPS.

A wireless pedestrian dead reckoning system (Lei et al., 2005) that combines inertial sensing and sensor network technology, called the NavMote is also in the research for indoor

positioning. The NavMote gathers information about pedestrian motion from an integrated magnetic compass and accelerometers. When the NavMote comes within range of a sensor network, it downloads the compressed data to the network. The network relays the data via a RelayMote to an information center where the data are processed into an estimate of the pedestrian trajectory based on a dead reckoning algorithm. Static and dynamic calibrations of the compass data are crucial to compensate the heading errors. The dead reckoning performance is further enhanced by wireless telemetry and map matching. It was also shown in research that indoor navigation is possible with the aid of augmented pictures (Merico et al., 2007), i.e. pictures with a very wide aspect-ratio that have been dynamically annotated with navigation information. Each picture is the result of automatically stitching together regular photos that have been taken under control of a "mapping" application. The mapping application starts from building plans in standard format and a list of points-of-interest and identifies where pictures should be taken from. The whole process is almost completely automatic and makes it possible to "map" a new building in a few days. Photos are processed in order to create a set of scrollable pictures that are augmented in real time with markers that indicate the direction to take and the position of "relevant locations" that can be used to recalibrate the dead-reckoning position.

Despite that many research works have already been carried on realizing the concept of wireless navigation system, local positioning system is still more favourable over GPS for indoor context. In similar approach as NavMote discussed by Lei et al., 2005, the target is for wheelchair-bounded aged and disabled people. In the implementation setup, radio frequencies of 433.98 MHz are used to set up a simple location determining network. As for direction determination, a 1490 digital compass sensor manufactured by Robson Company is being used. The sensor is a solid state Hall-effect device that is sensitive enough to detect the Earth's weak magnetic field and when rotated, outputs 4-bit digital signals that represent the compass' cardinal points to the microprocessor. Apart from the RF navigation system, a voice-activated powered module is also proposed to be incorporated with a joystick enabled wheelchair. The voice recognition system as described in the previous section recognizes voice commands and compares to those in the pre-stored memory; the respective coded digital signals would then be sent to the microcontroller which provides the relevant outputs to the wheelchair accordingly. With a voice-activated system, more convenience is hence brought to the disabled people. Additionally, a recent survey indicates that almost all of the people are not able to control the EPW by conventional methods and these users could benefit from the automated navigation system. Moreover, there are situations in which the user wants to travel from one location to another within a building either at home or at workplace repeatedly several times in a day (for example going to the toilet) (Pačnik et al., 2005). These users would benefit if a learning mechanism can be built into the wheelchair control system such that it would learn the path in an iterative manner and after few trials/iterations the controller would be able to take care of the navigation system making the user free to do something else or even relax. This is accomplished by integrating the Wireless Sensor Network (WSN) technology based on Zigbee protocol onto the EPW. The user first selects the destination he/she targets to go, through the WSN information; the indicator will guide the user on the EPW accordingly.

4.2 Navigation Methodology

Generally, in any navigation techniques, there are two possible ways widely used in directing a user from the starting point to the desired destination: The first method is to provide a general direction for the navigator to travel upon (unplanned routes) and the second method is to guide the user from one section to another (planned routes); Both techniques would eventually lead the user to his final destination. The illustrations and explanations of the navigation methodology are shown in the two figures in Figs. 16 and 17:

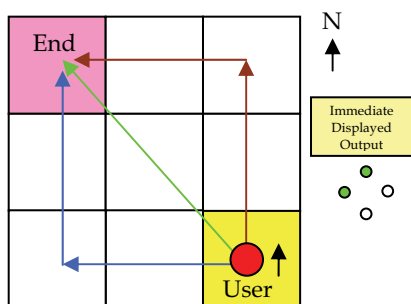

Fig. 16. Illustration on Unplanned Routing Methodology

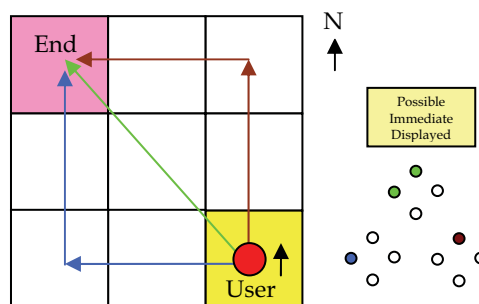

Fig. 17. Illustration on Planned Routing Methodology

Initially, the user starts from a random location, say the yellow grid, and he is facing the north direction as shown in Fig. 16. The final destination is to travel to a facility that is located in the pink grid. If the navigation system is programmed according to the unplanned routing methodology, the immediate displayed option would be as that shown in the diagram – directing him NorthWest with respect to where he/she is facing. This output direction indicates that his destination is somewhere along the NorthWest line, hence the user can choose to travel in the green line (fastest route), blue line, brown line or any other variations because all options would still lead him to his end point. In summary, the output directions given through the unplanned routing system always point the user DIRECTLY towards his destination. Consider the same scenario as seen in Fig. 17 but this time round, the output could be either the green, blue or brown route. This is dependent on how the route was planned beforehand and the user can make the choice out of the three options. In summary, the output directions given through the planned routing system need not always point to the destination directly. The user has to follow the navigation outputs accordingly to reach his destination, since he is not aware of where his endpoint lies.

Table.2 summarizes the comparisons between the two navigation methods. Based on the comparisons made between the unplanned and planned routing methodologies tabulated in Table.2, it can be concluded that adopting the planned routing method would be more appropriate for the aged and disabled people. The most important advantage of planned route over the unplanned route is that it can serve as an obstacle avoidance director. The scenario illustrated in Fig. 17 summarizes all the key benefits of planned routing methodology

	Unplanned routing	Planned routing
Output	Always point to end destination	Not necessarily point to end destination
Degree of freedom	High	Low
Distance traveled	Minimum	Varies
Time required	Varies	Varies
Ease of navigation	Low	High
Programming complexity	High	Low
Suitability for disabled	Low	High

Table 2. Comparison between the Unplanned and Planned Routing Methodologies

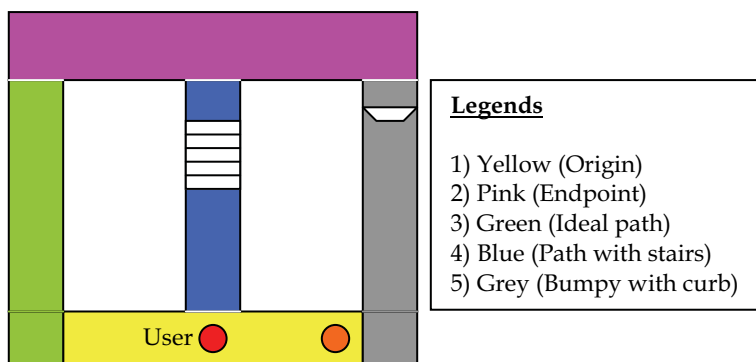

Fig. 18. Illustration to Show Key Benefits of Planned Routes Methodology

Consider a wheelchair user (red dot) who wishes to navigate to the pink region. There are three different paths for the user to choose of which the green path is the safest and easiest to cross. If the navigation system is adopting the unplanned routing method, the immediate output would be pointing the user straight ahead to the blue path, which is undesirable. However, if the planned routing method is to be used, the output would direct the user to turn left instead, towards the green route away from the blue and grey paths, so as to avoid the obstacles along those routes. When the user is in the green region facing his destination point, the output would be simply move forward. Likewise, for the user at the orange dot, it would be his immediate instinct to choose the grey path since the unplanned routing system would simply tell him that his destination is 'somewhere' straight ahead. However, the planned routing system would instruct the orange user to take the extra mile towards the green path because the path is the safest possible way for the user. A set of software codes has been developed to compute the relevant directions that are used to guide the user to the intended destination. The corresponding true navigation charts, depicting the respective outputs at different locations and directions, have to be prepared beforehand as well.

Function 1 (Current location = Yellow, Destination = pink)

Progress	A	B	C	D
*Current direction	N or NE	W or NW	S or SW	E or SE
Immediate output				

* Possible directions faced by user at the instance in time

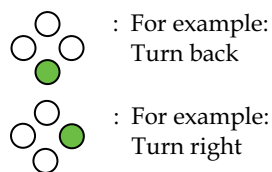

Function 2 (Current location = Grey, Destination = pink)

Progress	A	B	C	D
*Current direction	N or NE	W or NW	S or SW	E or SE
Immediate output				

Function 3 (Current location = Blue, Destination = pink)

Progress	A	B	C	D
*Current direction	N or NE	W or NW	S or SW	E or SE
Immediate output				

Function 4 (Current location = Green, Destination = pink)

Progress	A	B	C	D
*Current direction	N or NE	W or NW	S or SW	E or SE
Immediate output				

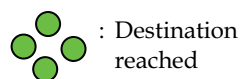

The 4 functions demonstrated as shown above aim to navigate the user residing in any of the locations to the pink destination region. Using the four functions, the sequences of the routing paths can be planned as the followings: -

Function 1 to 4 or Function 2 to 1 to 4 or Function 3 to 1 to 4

where Function 4 is the last function in all the 3 sequences, which is termed as the end function of the whole sequence. In the programming terms, regardless of the user's current location, the ultimate aim is to direct him to the end function eventually. In bigger and more complex layouts, there can be multiple end functions that lead the user to the same destination.

4.3 Location Determining System

System name	Signal	Method	Absolute positioning	Relative Positioning	Positioning	Tracking	Geometrical	Symbolic	Costs	Positioning Accuracy [m]
Active Badge	IR	CoO	X			X		X	Low	Room
WIPS	IR	CoO	X		X			X	Low	Room
Active Bat	US	ToA	X			X	X		Low	0,1
Cricket	US	ToA	X	X	X			X	Low	1,2
GSM	RS	TDoA/ AoA	X			X	X		Low	50-100
A-GPS	RS	ToA	X		X		X		High	20-25
Locata	RS	ToA	X		X		X		High	0,1-1
Radar	RS	SS	X		X	X	X		High	3-4
IMST ipos	RS	SS	X			X	X		High	1-3
Ekahau	RS	SS	X				X		High	1-3
Wi-Fi	RS	SS			X	X	X	X	High	N/A
WhereNet	RS	SS	X				X			N/A
UWB	RS	ToA/TDoA	X		X	X	X		High	0,2
Bluetooth	RS	CoO	X		X	X	X		Aver	10
SpotON	RS	SS	X	X	X	X	X		Aver	1
RF sensor network	RS	CoO		X				X	Low	1-20
Cybercode	VL	DI		X	X			X	Aver	Variable
Ubitrack	VL	DI		X		X	X		N/A	N/A
Easyliving	VL	DI	X			X	X		High	Variable

Table 3. Examples of Location Determining Systems

In the field of indoor positioning, it can be observed in Table.3 that many different location determining systems have been developed over the years; and signals such as infra red (IR), ultrasonic (US), radio signals (RS) and visible light (VL) are employed widely within them. Methods for position determination include Cell of Origin (CoO) where the location of the user is described in a certain cell area around the transmitter; Time of Arrival (ToA) where the travel time of a signal between a transmitter and receiver is obtained; Time Difference of Arrival (TDoA) where the time difference of signals sent from a transmitter is determined at two receiving stations and Signal Strength (SS) measurement for location determination using fingerprinting. These methods are employed in various systems of Wireless Fidelity (Wi-Fi), Assisted Global Positioning System (A-GPS), Bluetooth and Radio Frequency Sensor Networks such that location determination can be achieved. Among them, radio signals within the radio frequency (RF) refers to the electromagnetic field that is generated for wireless broadcasting and communications over a significant portion of the RF spectrum - from about 9 kilohertz (kHz) to thousands of gigahertz (GHz) is used. The idea is to develop a network of sensors, comprising of multiple transmitters, each of which emitting a

common frequency carrying different sets of data. Although this method does not offer absolute positioning, it is effective enough, for a close indoor setting, in providing general directions to the user towards his destination. In addition, the price of setting up a RF network is low compared to the above proposed suggestions. Because of all these factors, the RF sensor network is hence adopted as the location determining system.

4.4 Direction Determining System

With the location determining system in place, it is time to move on to the next vital component necessary in every navigation application: the setting up of a direction determining system. The most common method in determining direction is to make use of the Earth’s weak magnetic field. However this entails the use of certain magnetic techniques and devices. Table.4. gives the relative attributes of the four most widely used technologies: Hall effect, magnetoinductive, flux-gate and magnetoresistive.

Comparison of magnetic sensor technologies					
Technology	Sensitivity	Size	Cost	Power consumed	Comments
Magnetoinductive	High	Small	Low	Low	Provides digital (frequency) output, temperature compensation
Flux-gate	High	Medium	Medium	Medium	Provides analog output, temperature compensation
Magnetoresistive	High	Small	Medium	Medium	Provides analog output
Hall-effect	Low	Very small	Low	Medium	Provides analog output, subject to drift and high noise, amenable to IC-fabrication techniques

Table 4. Comparison of Magnetic Sensor Technologies

Hall-effect devices are the smallest and least expensive with the lowest sensitivity of the four magnetic sensor technologies. Their low cost and small size stem from their adaptability to monolithic-IC processing. The drawback of low sensitivity is overcome by the Dinsmore digital compass sensor by magnifying the earth’s field in order to bring it within the range of the sensor - by means of increasing its Hall coefficient, R_H . The Hall coefficient which measures the resulting Hall field is defined as:

$$R_H = \frac{E_H}{B * J} \tag{4}$$

$$V_H = \frac{-IB}{d * n * e} \tag{5}$$

where,

R_H is the Hall coefficient

E_H is the Hall field (proportional to Hall Voltage, V_H)

B is the applied magnetic flux density

J is the applied current density

I is the current across the plate length

B is the applied magnetic field

d is the depth of the plate

e is the electron charge

n is the bulk density of the carrier electrons.

According to the above two equations, a high Hall coefficient means that the sensor is able to sense a lower value of B (in this case the Earth's weak magnetic field) and result in a larger Hall field and hence Hall voltage – sufficient to be detectable.

4.5 Hardware Design and Implementation

The overall hardware design and implemented prototype of the navigation system consist of four main parts: 1) User interface which includes a LCD display and three input buttons (commands of 'scroll up', 'scroll down' and 'enter'); 2) One digital compass sensor for direction determining; 3) One receiver and four transmitters which make up the RF sensor network and 4) Output directional pad which consists of 4 LEDs. All these components are interfaced directly to the microcontroller as shown in Fig. 19.

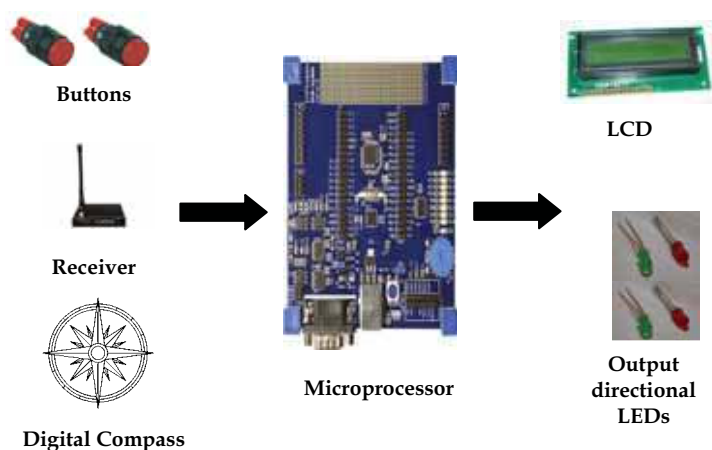

Fig. 19. Overall Block Diagram of the Personal Navigation System

The flow of the program written in the personal navigation system is illustrated in Fig. 20. Initially, the physical location of the user is determined by the location determining system mounted onboard the navigation system. The RF transmitters deployed at various points of the indoor location is set to continuously broadcast the location ID of that particular RF transmitter. Once the RF receiver of the navigation system receives any of the location IDs, the user's location will be known. Take for instance, the user is presently residing in the Linear Lab, the location ID of the lab is 0001 which is broadcasted to the RF receiver to

inform the user of his/her present location as illustrated in Fig. 20 After which, the user then selects the destination point (1/4 - 4/4). With the start point and end point information, the best route to travel between the points can be determined through the true navigation chart. Along the route, the direction determining system enables the indication LEDs accordingly to guide the user towards the selected destination.

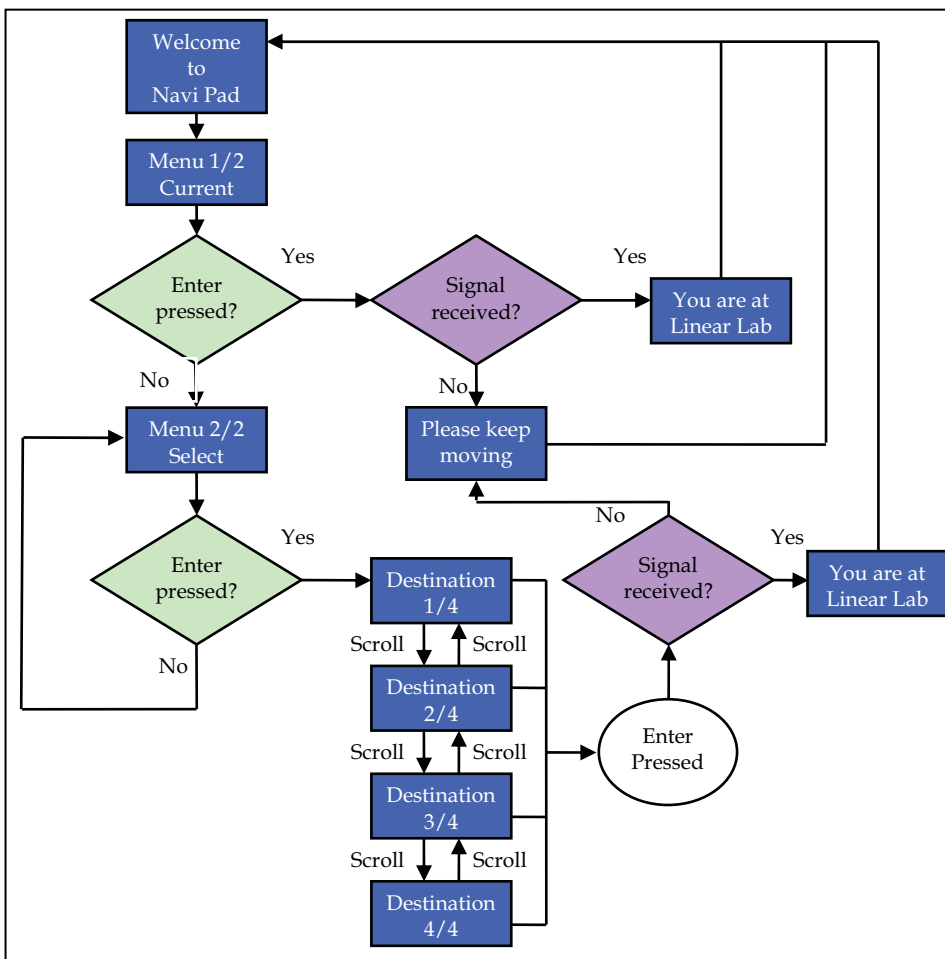

Fig. 20. Flowchart of Graphical User Interface (GUI) with Navigation System

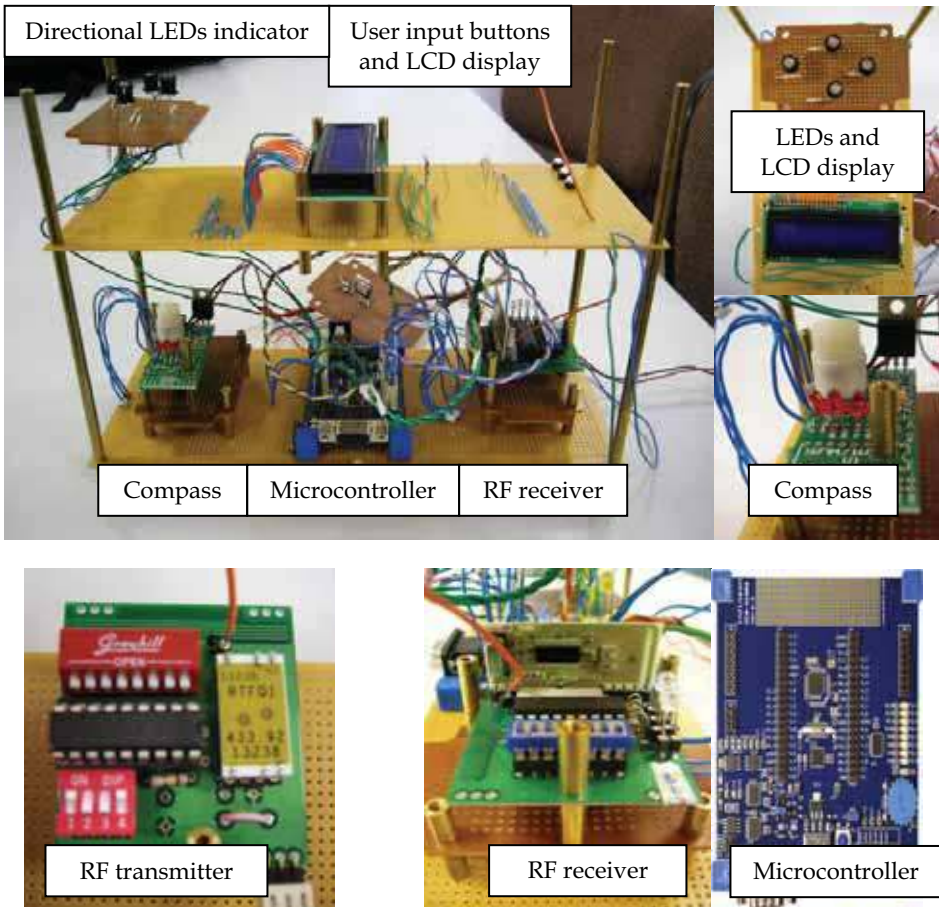

Fig. 21. Hardware prototype of personal navigation system based wireless sensor network

The design of the personal navigation system is implemented based on the WSN technology for indoor application. The system has been developed into hardware prototype for testing as shown in Fig. 21. The RF transmitter acts like a sensor node that keeps broadcasting the location ID via the 433.92 MHz frequency band. The microcontroller is used to process the 4-bit location ID received from the RF receiver as well as the directional signal sensed by the compass unit. The processed information is then conveyed to the user via the LCD display. The user can select his/her choice from the list of destinations recorded in the memory of the microcontroller and the navigation system will then guide the user to the end destination via the most suitable path routed based on the true navigation chart.

5. Motorized Foot Rest for Electric Powered Wheelchair

5.1 Introduction on Wheelchair Foot Rest

Wheelchair foot rests are known by many names including front rigging, foot rest, lower leg support, wheelchair leg supports, or just wheelchair legs to name a few (McLaurin & Axelson, 1990). The foot rests are installed on the wheelchair as the base of support to the lower limbs of the wheelchair user and they prevent excessive sliding motion and discomfort feeling to the lower limbs of the wheelchair-bounded aged and disabled individuals. At present, the conventional foot rests are adjusted manually by some external assistances to meet the desired height and position required by the user. Ironically, the wheelchair users often have limited strength in their arms and torso and thus most of the time they can only depend on the wheelchair in sedentary position. Hence, the users are hardly able to move their legs or feet supported by the conventional fixed foot rest due to weakness in their lower part of their body. In this way, there must be somebody at the side of the user to help in lifting the users' feet from the ground onto the pad of foot rest. This creates some form of inconvenience to both the wheelchair users and the people around them. Both physical and psychological barriers obstruct the wheelchair users from walking out of their homes to enter into the society. Another problem is that if the user's legs are too short and the resting pad is too far down from the seat, it would be very uncomfortable to dangle the legs and feet in the air since the foot rest is very difficult for the user himself/herself to manually adjust to the desired position.

One very severe problem for wheelchair users is the long period of time sitting on the wheelchair where they have very minimum chances to exercise and the problem of poor blood circulation and physical inactivity (Cooper et al., 1994) will become critical. With considerations of the few critical problems and limitations related to the conventional foot rest, a motorized foot rest has been designed to overcome those problems and a model prototype is developed to demonstrate the working principles and feasibility of the motorized foot rest for electric powered wheelchair. The motorized foot rest has to be able to assist the wheelchair users to lift up their feet from the ground without any external assistance and adjust the length and angle of the motorized foot rest to provide a most comfortable position for the user to put their feet. The motorized foot rest must also provide the wheelchair users the rehabilitative means to exercise their legs in order to improve blood circulation in the legs.

5.2 Importance of Adjustable Foot Rest for Wheelchair-Dependent Individuals

Lower leg support is a generic term, describing a variety of products, such as legrest pads, calf straps and kneelers. Elevating legrests are generally used to augment venous circulation and reduce depended edema, or to fix the knee in extension as a result of orthopedic deformity, surgical immobilization, or severe hypertonicity in the extensors. The importance of elevating foot-rests for easier patient transfer and wheelchair stability has also been described (Aissaoui et al., 2000). A basic misconception regarding leg position in the wheelchair is that in order to reduce pressure under ischial tuberosities, the feet of a person in a wheelchair should bear little or no weight. The detrimental effects for wheelchair-dependent individuals sitting with the legs hanging freely or with minimal foot support have been described as follows: 1) it is very unstable sitting posture, as the weight of the unsupported legs destabilizes the trunk; 2) it is a fatiguing sitting posture, resulting in an

increase in back muscle activity in an attempt to stabilize the trunk; 3) the weight of the unsupported legs creates a force that causes the pelvis to slide forward on the seat. The individual ends up in a slumped posture, with an increase in pressure and shearing forces over and posterior to ischial tuberosities.

The rationale behind footplate adjustment usually appears to be empirically-based and varies between authors. It was found that proper foot support would reduce 18.4% of the body weight from the seat. Using able-bodied subjects sitting in a wheelchair, Bush found no significant difference on ischial pressure when the feet were hanging freely compared to when the legs were fully extended. Gilsdorf et al. found that the lowest ischial interface pressures on any cushion were with the legs dangling. They acknowledged however, that it is impractical to leave a wheelchair user's legs without support. In the study of Hobson, the foot-rests were adjusted to take approximately 10% of the body weight, while in the study of Koo et al. they are adjusted so that the thighs are horizontal. The influence of foot-rest position on seat pressure distribution was investigated in. Although based on a single subject, this study clearly showed that optimal foot-rest adjustment is essential for minimizing peak pressure on the seat. Raising the footplate height can increase ischial pressure by as much as 100%, compared to when they are as low as possible but still supporting the foot.

All these studies have focused on the length of the foot-rest i.e. the distance from the front seat to the foot supports. Aissaoui et al. (2000) found that peak pressure gradient around ischial tuberosities increased significantly by 20% when the foot-rest angle was changed from 90 to 45 with respect to the horizontal. Moreover, the elevation of the leg supports is directly related to knee extension. In fact, the angulation of lower leg supports can affect the posture of the sitter's hip if the angular modification changed the distance from the seat front to the foot supports. This change results from the fact that the foot-rest's axis of motion is not aligned with the knee joint axis. This interdependency between foot-rest angularity and the distance between the foot support and seat, requires the linear placement of the lower leg and foot support to be adjusted in synchrony with the foot-rest's angular modification. Products that do not address this changing geometry can cause sitter discomfort and soft tissue trauma. For example, if a foot-rest is elevated and the foot support is not lengthened, then the hip and knee joints is forced into flexion, and weight-bearing pressure increases under ischial tuberosities. This risk of pressure increase can be avoided by selecting equipment that allows the foot supports to lengthen as the foot-rest procline. This mechanism has led to a design of a new foot-rest called a compensatory (CMP) foot-rest, in contrast with a conventional (CNV) foot-rest that had a fixed axis of rotation. However, no data exist in literature to corroborate the beneficial effect of the CMP foot-rest. The purpose of this study is to compare the effects of the CNV and the CMP foot-rests on posture and pressure distribution of ten able-bodied subjects while sitting in a manual wheelchair. In this study, we hypothesized that the CMP foot-rest will compensate for the knee joint motion. This compensation will preserve the posture adopted initially by subjects when the legrest is set vertically. Moreover, thigh and pelvic motion will be minimized when extending the knee joint, and pressure distribution at the body-seat interface will be reduced when using the CMP foot-rest. The biomechanics part of the leg and foot rest affecting the user is not going to be the main focus of this section. What we want to discuss in this section of the chapter is the practical implementation of a motorized

foot-rest to help the user to overcome the above mentioned problems arising from prolong sitting and improper leg resting position.

5.3 Design and Prototype of Motorized Foot Rest

The motorized foot rest has to be designed to enhance the assistive and rehabilitative needs of the disabled and aged population. There are several factors to be considered when the motorized foot-rest is designed such as the weight of the foot rest, number of motors used, construction of the design, types of materials needed, overhead and manufacturing costs, etc. The initial stage of prototyping the motorized foot rest was carried out and the model prototype is developed as illustrated in Fig. 22.

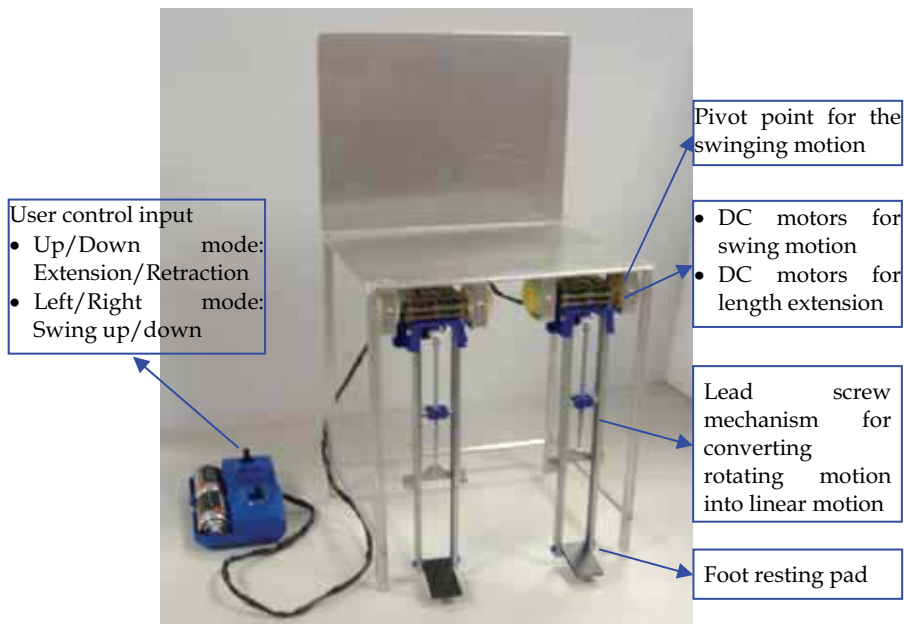

Fig. 22. Prototype of the motorized foot rest

The DC motors are designed to be placed between the top of the entire foot rest and the seating chair as shown in Fig. 22. This is done to minimize the effect of the heavy weight of the motors and its associated mechanisms adding on the foot rest. Less electrical power is needed to lift up the lower moving part of foot rest, hence smaller and low-powered motors can be used which will reduce the overall system cost as well as the power consumption of the motors and its associated drive system. The present design allows two degrees of freedom namely one rotational and one linear movement so as to attain the necessary motions required in the assistive and rehabilitative needs of the disabled and aged population.

During the experiments, several tests were carried out to determine the motion speed, the extension distance and the swing angle attainable. It is found that the motorized foot rest can move up and down in the linear motion at an average speed of 6 mm/sec. The foot rest

can extend as long as to a maximum length of 30 cm with respect to the original length of 18 cm. For the rotational motion, the foot rest is managed to swing a maximum angle of 90 degrees. The whole motorized foot rest system is powered up by an external DC power supply.

Components	Descriptions
Control system	A joystick to control the rotational and linear movements by moving the control stick to the left, right, forwards and backwards.
Rotational and linear drives and motoring	DC motors and gearboxes to control the rotational and linear movements of the foot rest
Movable mast	Movable mast, threaded shaft/lead-screw to convert rotational motion to linear motion. When motor starts to rotate, the lead-screw rotates accordingly to produce the linear motion.

As mentioned above, the motorized foot rest has to be capable of assisting the user to lift up his/her feet from the ground. The assistive process can be explained as follows. Firstly, the user controls the foot rest to extend its length until both the resting pads touch the ground as shown in Fig. 23. The user can then easily dragged his/her feet onto the resting pad by himself/herself or if the user is having severe upper limb problem, somebody besides the user can easily assist. After which, the motor is activated to lift the user's feet up into the air. With the motorized foot rest, the whole process of lifting the wheelchair user's feet onto the foot rest requires very bare minimum help from people around the user. Once the user's feet is resting on the foot rest, he/she can adjust the length and swing angle accordingly as shown in Fig. 24 and Fig. 25 respectively to suit his/her comfortable position.



Fig. 23. Motorized foot rest at stationary position

Fig. 24. Motorized foot rest after swing angle adjustment

Fig. 25. Motorized foot rest after length adjustment



Fig. 26. Illustration of leg lifting exercise (Assistive need)



Fig. 27. Illustration of walking exercise (Rehabilitative need)

Having a controllable motorized foot rest, the user can adjust his/her sitting position on the wheelchair to the most comfortable one with the flexibility in adjusting the foot rest position. The user simply manipulates the joystick i.e. up/down or left/right to control both the linear and rotational motions of the foot rest. By doing so, both the vertical length and swing angle can be changed. Take for an example, if the user has long legs, he/she can increase both the length of the foot rest to fit his long leg as well as the swing angle to seek for a comfortable position as illustrated in Fig. 24 to Fig. 25.

Other than supporting the assistive need, the motorized foot rest can be designed to provide some rehabilitative exercises to users so as to move their legs for blood circulation. This can be done by applying the linear or rotational motions continuously; control the foot rest to move up and down (see Fig. 25) or to rotate the swing angle continuously (see Fig.26). This is done by pushing the control sticks forward and backward alternatively to apply linear motion and in the similar way for the rotational motion. The lower limbs including thighs, legs and feet of the wheelchair users are often moving and exercising, just like any healthy person. This encourages blood circulation and physical reaction, which is beneficial to the users' health and recovery.

6. Conclusion

The chapter has discussed about the ageing problem of the world population as well as the increasing amount of disabled people that are wheelchair-bounded. Electric-powered wheelchair is very favourable among people with both lower and upper extremity impairments because EPWs provide excellent functional mobility and comfort as comparable to the manual wheelchairs. However, people with severely impaired physical disabilities are challenged in operating conventional EPWs in some domestic environments. The chapter has introduced three technological solutions to help many aged or disabled people who are dependent on human caregivers to perform daily tasks by themselves. The combined solution of the microcontroller based voice-activated electric-powered wheelchair equipped with the personal navigation system based on wireless sensor network and the motorized foot rest has been described. Experimental results obtained have verified the

solution leads to engineering better EPW to enhance the rehabilitative and assistive needs of the disabled and aged people.

7. Acknowledgements

The authors would like to acknowledge the project works of Mr. David Ang, Ms Jinzhou Yi, Ms Yue Yu, Ms. Hong Wu and Ms Pei Liu, who are students supervised by Associate Professor Sanjib Kumar Panda and Professor Jianxin Xu. Special thanks to be expressed to Associate Professor Sanjib Kumar Panda for his great help in reviewing the chapter.

8. References

- Aissaoui R., Heydar S., Dansereau J. & Lacoste M. (2000). Biomechanical analysis of legrest support of occupied wheelchairs: comparison between a conventional and a compensatory legrest, *IEEE Transactions on Rehabilitation Engineering*, Vol. 8, Issue. 1, pp. 140-148
- Beno, J., Thompson, R. & Hebner, R. (2002)., Flywheel Batteries for Vehicles, *Proceedings of the Workshop on Autonomous Underwater Vehicles*, pp. 99-101
- Cecelja F., Garaj V., Hunaiti Z. & Balachandran W. (2006). A Navigation System for Visually Impaired Pedestrians, *International conference on Instrumentation and Measurement (IMTC 06)*, Sorrento, Italy
- Chen R.X., Chen L. G., & Chen L. (2000). System Design Consideration for Digital Wheelchair Controller, *IEEE Transactions on Industrial Electronics*, Vol. 47, No. 4, pp. 898-907
- Committee on Ageing Issues (CAI) (2006). Report on the Ageing Population, Five-Year Masterplan, *Ministry of Community Development, Youth and Sports (MCYS)*, Singapore
- Cooper R.A., Stewart K. L., VanSickle D. P., Albright S. J., Heil T. (1994). Manual wheelchair ISO-ANSI/RESNA fatigue testing experience, *Proceeding of RESNA '94*, Nashville, TN, pp. 324-326
- Cooper R.A. (1998). Wheelchairs: A Guide to Selection and Configuration, NY: *Demos Medical Publishers*, New York
- Cooper R.A. & Tai C. (1998). Feasibility of flywheel batteries for electric powered wheelchairs, *Proceedings of the 20th Annual International Conference of the IEEE Engineering in Medicine and Biology Society*, Vol. 5, No. 5, pp. 2261-2263
- Cooper R.A., Widman L. M., Jones D. K., Robertson R. N. & Ster J. F. (2000). Force Sensing Control for Electric Powered Wheelchairs, *IEEE Transactions on Control Systems Technology*, Vol. 8, No. 1, pp. 112-117
- Cooper R.A. & Cooper R. (2003). Trends and Issues in Wheeled Mobility Technologies, Retrieved February 5, 2004, from [http://www.ap.buffalo.edu/ideaproto/Space%20Workshop/Papers/WEB%20-%20Trends_Iss_WC%20\(Cooper\).htm](http://www.ap.buffalo.edu/ideaproto/Space%20Workshop/Papers/WEB%20-%20Trends_Iss_WC%20(Cooper).htm)
- Cooper R.A., Boninger M.L., Spaeth D. M., Ding D., Guo S., Koontz A.M., Fitzgerald S.G., Cooper R., Kelleher A. & Collins D.M. (2006). Engineering Better Wheelchairs to Enhance Community Participation, *IEEE Transactions on Neural Systems and Rehabilitation Engineering*, Vol. 14, No. 4, pp. 438-455

- Cooper R.A., Dicianno B.E., Brewer B., LoPresti E., Ding D., Simpson R., Grindle G., Wang H. (2008). A perspective on intelligent devices and environments in medical rehabilitation, *Medical Engineering & Physics*, Vol. 30, No. 10, pp. 1387-1398
- Dicianno B E., Spaeth D M., Cooper R A., Fitzgerald A. G., Boninger M. L. & Brown K. W. (2007). Force Control Strategies While Driving Electric Powered Wheelchairs With Isometric and Movement-Sensing Joysticks, *IEEE Transactions On Neural Systems And Rehabilitation Engineering*, Vol. 15, No. 1, pp. 144-150
- Ding D. & Cooper R. A. (2005). Electric-powered wheelchairs, *IEEE Control Systems Magazine*, Vol. 25, No. 2, pp. 22-34
- Institute of Public Affairs, edited by Moran A. (2005). Impact and Outcome of Regulation on the Economy, *Institute of Public Affairs Ltd*, Melbourne
- Kuruparan J., Jayanthan T., Raheeskanth V., Denixavier S. & Munasinghe S. R. (2006). Semiautonomous Low Cost Wheelchair for Elderly and Disabled People, *International Conference on Information and Automation (ICIA 2006)*, pp. 104-108
- Jirawimut R., Ptasinski P., Garaj V., Cecelja F. & Balachandran W. (2003). A Method for Dead Reckoning Parameter Correction in Pedestrian Navigation System, *IEEE Transactions On Instrumentation And Measurement*, Vol. 52, No.1, pp. 209-215
- Jones D. K., Cooper R. A., Albright S. & DiGiovine M. (1998). Powered Wheelchair Driving Performance Using Force- and Position-Sensing Joysticks, *Proceedings of the IEEE 24th Annual Northeast Bioengineering Conference*, pp.130-132
- Latiff L., Ali A., Ooi C., & Fiscal N. (2005). Development of an Indoor GPS-free Self Positioning System for Mobile Ad Hoc Network (MANET), *MICC-ICON 2005*, Malaysia
- Lei F., Antsaklis P.J., Montestruque L.A., McMickell M.B., Lemmon M., Yashan S., Fang H., Koutroulis I., Haenggi M., Xie M. & Xie X. (2005). Design of a wireless assisted pedestrian dead reckoning system - the NavMote experience, *IEEE Transactions on Instrumentation and Measurement*, Vol. 54, Issue. 6, pp. 2342-2358
- McLaurin C.A. & Axelson P. (1990). Wheelchair standards: an overview, *Journal of Rehabilitation Research & Development*, Vol. suppl, pp. 100-109
- Merico D. & Bisiani R. (2007). Indoor Navigation with Minimal Infrastructure, *Proceeding of 4th Workshop Positioning, Navigation and Communication (WPNC 07)*, pp. 141-144, IEEE Press
- Nisbet P. (1996). Integrating assistive technologies: current practices and future possibilities, *Medical engineering & physics*, Vol. 18, No. 3, pp. 193-202
- Oskoei M. A. & Hu H. (2008). Myoelectric based Virtual Joystick Applied to Electric Powered Wheelchair, *IEEE/RSJ International Conference on Intelligent Robots and Systems*, pp. 2374-2379, Nice, France
- Pačnik G., Benkič K. & Brečko B. (2005). Voice Operated Intelligent Wheelchair - VOIC, *IEEE International Symposium on Industrial Electronics (ISIE)*, pp. 1221-1226
- Patel S. N., Troung K. N. & Abowd G. D. (2006). PowerLine Positioning: A Practical Sub-Room-Level Indoor Location System for Domestic Use, *Proceedings of 8th International Conference of Ubiquitous Computing*, pp. 441-458, California, USA
- Stanton K. B., Sherman P. R., Rohwedder M. L., Fleskes C. P., Gray D. R., Minh D. T., Espinoza C., Mayui D., Ishaque M. & Perkowski M. A. (1990). PSUBOT - A Voice-Controlled Wheelchair For The Handicapped, *Proceedings of the 33rd Midwest Symposium on Circuits and Systems*, Vol. 2, pp. 669 - 672

- United Nations (2005). *World Population Prospects The 2004 Revision, Department of Economic and Social Affairs (Population Division)*, New York
- Usui S., Tsuji J., Wakimoto K., Tanaka S., Kanda J., Sato F. & Mizuno T. (2005). Evaluation of Positioning Accuracy for the Pedestrian Navigation System, *IEICE Trans Commun.*, Vol. E88-B, pp.2848-2855

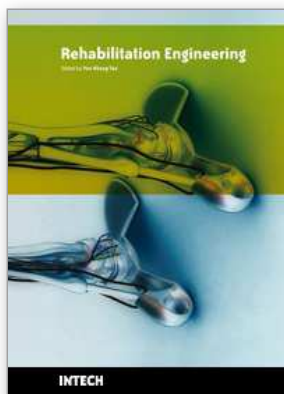

Rehabilitation Engineering

Edited by Tan Yen Kheng

ISBN 978-953-307-023-0

Hard cover, 288 pages

Publisher InTech

Published online 01, December, 2009

Published in print edition December, 2009

Population ageing has major consequences and implications in all areas of our daily life as well as other important aspects, such as economic growth, savings, investment and consumption, labour markets, pensions, property and care from one generation to another. Additionally, health and related care, family composition and life-style, housing and migration are also affected. Given the rapid increase in the aging of the population and the further increase that is expected in the coming years, an important problem that has to be faced is the corresponding increase in chronic illness, disabilities, and loss of functional independence endemic to the elderly (WHO 2008). For this reason, novel methods of rehabilitation and care management are urgently needed. This book covers many rehabilitation support systems and robots developed for upper limbs, lower limbs as well as visually impaired condition. Other than upper limbs, the lower limb research works are also discussed like motorized foot rest for electric powered wheelchair and standing assistance device.

How to reference

In order to correctly reference this scholarly work, feel free to copy and paste the following:

Yen Kheng Tan and Sangit Sasidhar (2009). Engineering Better Electric-Powered Wheelchairs To Enhance Rehabilitative and Assistive Needs of Disabled and Aged Populations, Rehabilitation Engineering, Tan Yen Kheng (Ed.), ISBN: 978-953-307-023-0, InTech, Available from:
<http://www.intechopen.com/books/rehabilitation-engineering/engineering-better-electric-powered-wheelchairs-to-enhance-rehabilitative-and-assistive-needs-of-dis>

INTECH

open science | open minds

InTech Europe

University Campus STeP Ri
Slavka Krautzeka 83/A
51000 Rijeka, Croatia
Phone: +385 (51) 770 447
Fax: +385 (51) 686 166
www.intechopen.com

InTech China

Unit 405, Office Block, Hotel Equatorial Shanghai
No.65, Yan An Road (West), Shanghai, 200040, China
中国上海市延安西路65号上海国际贵都大饭店办公楼405单元
Phone: +86-21-62489820
Fax: +86-21-62489821

© 2009 The Author(s). Licensee IntechOpen. This chapter is distributed under the terms of the [Creative Commons Attribution-NonCommercial-ShareAlike-3.0 License](#), which permits use, distribution and reproduction for non-commercial purposes, provided the original is properly cited and derivative works building on this content are distributed under the same license.