Amygdala and Jaw Movements: A Hodological Review

Yukihiko Yasui

Additional information is available at the end of the chapter

<http://dx.doi.org/10.5772/67581>

Abstract

The organization of emotional motor behavior including jaw movements is governed by neural circuits of the limbic system, such as the amygdala and hypothalamus. GABAergic neurons in the central amygdaloid nucleus (CeA) exert an inhibitory influence on premotor neurons for the trigeminal motor nucleus (Vm) in the parvicellular reticular formation (RFp) of the medulla oblongata. The CeA also influences glutamatergic posterior lateral hypothalamic neurons and non-dopaminergic neurons in the retrorubral field of the midbrain, both of which send their axons to Vm-premotor neurons in the RFp. In addition, the CeA may modulate the activity of Vm motoneurons via projections to the mesencephalic trigeminal nucleus whose neurons convey inputs from the masticatory muscle spindles and periodontal ligament receptors to jaw-closing motoneurons in the Vm. These pathways from the amygdala to the trigeminal motor system in the lower brainstem may underlie the regulation of emotional jaw movement.

Keywords: amygdala, motor trigeminal nucleus, jaw movement, neural pathway, emotion

1. Introduction

The amygdala is an almond-shaped set of neurons located deep in the medial temporal lobe of the cerebral hemisphere. Although the amygdala is ontogenetically a part of the basal ganglia, it is a major component of the limbic system. The limbic system is composed of the phylogenetically old limbic lobe, such as the cingulate gyrus and hippocampal formation, and subcortical structures including the amygdala, hypothalamus, anterior thalamic nucleus, and connecting parts (for review, see Ref. [1]). The amygdala is functionally involved in the regulation of instinctive behavior (including sexual and feeding behavior), and in autonomic function as well. The amygdala has also attracted recent attention as a center of emotional expression.

According to Ledoux [2] and Ledoux et al. [3], emotional expression consists of a three-step evaluative process: (1) the acceptance of sensory stimuli, (2) the evaluation of the biological value of the sensory stimuli, and (3) the expression of emotion and subjective experience based on such evaluation. As shown in **Figure 1**, the amygdala receives not only a variety of sensory information from the thalamus and association cortices but also visceral sensory information from brainstem nuclei, such as the nucleus of the solitary tract and parabrachial nucleus. This information serves as emotional stimuli. Within the context of the bases of information of these emotional stimuli sent via the hippocampal formation, the amygdala evaluates the biological value of the emotional stimuli, subsequently inducing a subjective experience of emotion and expression of emotion. Such subjective experiences of emotion (e.g., feelings of rage or pleasure) are processes, which occur within our minds, with the expressions of emotion manifesting as emotional behavior, as well as autonomic and endocrine responses. Emotional behaviors are visible physical changes, of which the orofacial (i.e., jaw) movements being perhaps the more notable.

In this chapter, I would like to describe possible neuronal pathways from the amygdala to the trigeminal motor system that are responsible for emotional jaw movement.

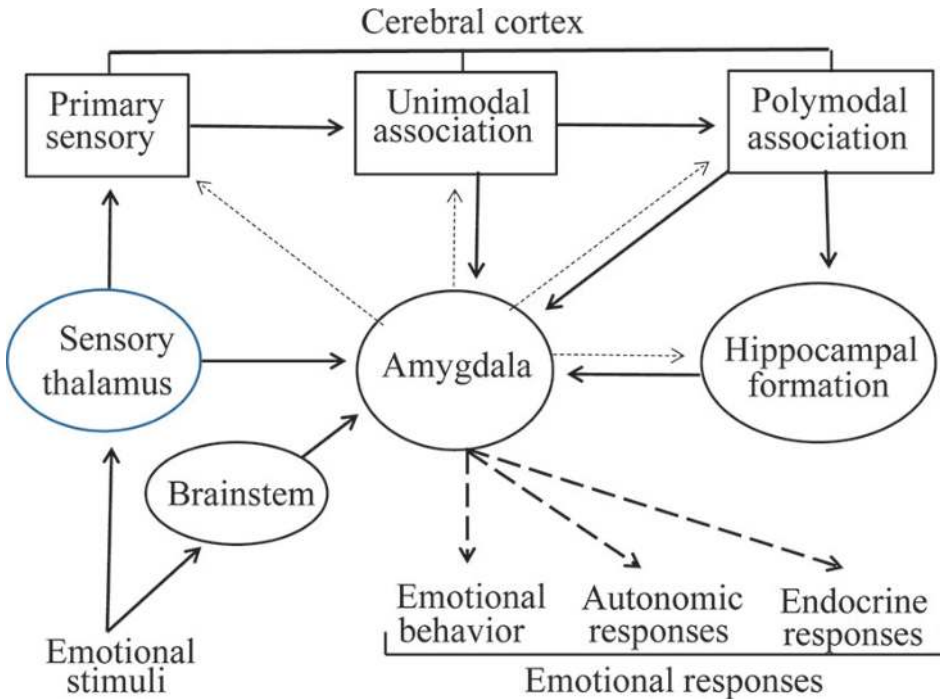

Figure 1. Schematic overview of emotional processing neural circuits (modified from LeDoux [3]). Various forms of sensory inputs that become emotional stimuli are sent to the amygdala via the thalamus and association cortices as well as via the brainstem nuclei. The context of these emotional stimuli is sent to the amygdala via the hippocampal formation. The amygdala integrates this information and evaluates the biological value of emotional stimuli. Subsequently, subjective experience of emotion and expression of emotion are induced. The expression of emotion consists of emotional behaviors, autonomic responses, and endocrine responses.

2. Amygdala and emotional motor system

The limbic region, known to be involved in emotional functions, has descending motor pathways and influences the responses of both skeletal muscles and autonomic functions. These descending motor pathways are called the “emotional motor system,” while the voluntary motor pathways from the motor and premotor cerebral cortex to the brainstem and spinal cord are called the “somatic motor system” [4].

Both the somatic motor and emotional motor systems have medial and lateral components. In the somatic motor system, the medial component consists of pathways, which directly and indirectly control motoneurons innervating axial and proximal body musculature as well as neck muscles. These pathways originate not only in the motor and premotor cortices but also in the brainstem structures, such as the reticular formation, superior colliculus, and red and vestibular nuclei.

The lateral component of the somatic motor system consists of descending pathways originating mainly in the motor cortex and controlling motoneurons innervating distal body muscles, that is, arm, hand, leg, and feet muscles. In the brainstem, the medial and lateral components of the somatic motor system control motoneurons innervating external eye muscles and orofacial muscles, respectively.

The emotional motor system originates from the amygdala, bed nucleus of the stria terminalis, and hypothalamus. Its medial component projects to all parts of the spinal cord, and to all sensory and motor nuclei in the brainstem via, among others, serotonergic neurons in the raphe nuclei and noradrenergic neurons in the locus coeruleus. Due to the diffuse nature of these pathways, the medial component is not involved in specific motor actions but is implicated in setting the general level of activation of all neurons in the brainstem and spinal cord.

The lateral component of the emotional motor system consists of pathways, which control not only motoneurons involved in forming specific emotional behaviors but also neurons involved in regulating autonomic functions accompanying such behaviors. This projection system regulates motoneurons in the brainstem and spinal cord controlling respiration, blood circulation, vocalization, and mating behavior mainly via the periaqueductal gray [5]. Other projections of the lateral component are the descending pathways from the central amygdaloid nucleus (CeA), the bed nucleus of the stria terminalis, and the lateral hypothalamic area (LHA), terminating in the caudal pontine and medullary lateral tegmentum (for review, see Ref. [6]). The lateral tegmentum of the pons contains the parabrachial nucleus and reticular formation around the motor trigeminal nucleus (Vm), while that of the medulla oblongata contains the parvicellular reticular formation (RFp) and ventrolateral medulla. The parabrachial nucleus and ventrolateral medulla contain many neurons involved in autonomic functions, while the reticular formation around the Vm and RFp contains numerous premotor neurons projecting directly to the orofacial motor nuclei including the Vm, facial nucleus (VII), and hypoglossal nucleus (XII).

In light of the above, it is highly likely that projection fibers from the limbic region, such as from the amygdala, to the lateral tegmentum are involved in the regulation of autonomic

functions as well as the control of orofacial muscle movements during aggression, freezing, and other emotional behaviors.

3. Somatotopic arrangement of Vm motoneurons

Jaw movement occurs mainly through the masticatory and suprahyoid muscles attached to the mandibular bone. The masticatory muscles, mylohyoid muscle, and the anterior belly of the digastric muscle are innervated by motoneurons in the Vm located in the dorsolateral tegmentum of the pons. Within the Vm, neurons innervating each muscle are assembled and constitute subgroups. The motoneurons innervating the jaw-closing muscles, such as the masseteric and temporalis muscles, are assembled in the dorsolateral part of the Vm (Vm-dl), while those innervating the jaw-opening muscles, such as the mylohyoid and the anterior belly of the digastric muscle, are assembled in the ventromedial part of the Vm (Vm-vm) [7, 8].

4. Premotor neuron pools for Vm

Jaw movement is triggered by Vm motoneurons, which, in turn, are activated by input from periphery and/or upper motor centers in the brain transmitted to the Vm via interneurons called premotor neurons, primarily located in the brainstem. The Vm-premotor neurons send their axons directly to the Vm, with many distributed in the lower brainstem, such as the pons and medulla oblongata [9–11] (**Figure 2**). A large number of Vm-premotor neurons are found in the sensory trigeminal nuclei including the mesencephalic trigeminal nucleus (Vmes), and principal and spinal trigeminal nuclei. A greater number of them are distributed in the lateral reticular formation, including the reticular formation around the Vm, RFp, and intermediate reticular nucleus (IRt) of the pontomedullary brainstem.

The reticular formation around the Vm, considered an extension of the medullary RFp, consists of the supratrigeminal area dorsal to the Vm, the intertrigeminal area between the principal sensory trigeminal nucleus and the Vm, the juxtatrigenial area just medial to the Vm, and the reticular formation just ventral to the Vm. The Vm-premotor neurons (excepting Vmes neurons) are generally distributed bilaterally and play a major role in the initiation and regulation of jaw movement, serving as interneurons in brainstem reflexes and transmitting information from upper motor centers to Vm motoneurons. By contrast, Vmes neurons, which innervate jaw-closing muscle spindles and periodontal mechanoreceptors [12–14], send their axons ipsilaterally to Vm motoneurons for controlling jaw movement [13, 15].

The RFp of the medulla oblongata also contains numerous premotor neurons for the facial (VII) and hypoglossal (XII) nuclei. With the aid of a fluorescent retrograde double-labeling technique, Li et al. [16] demonstrated that the RFp contains many premotor neurons projecting bilaterally to one of the orofacial motor nuclei (the Vm, VII, and XII) by branching axons. Their data also indicated that single neurons in the RFp project simultaneously to two

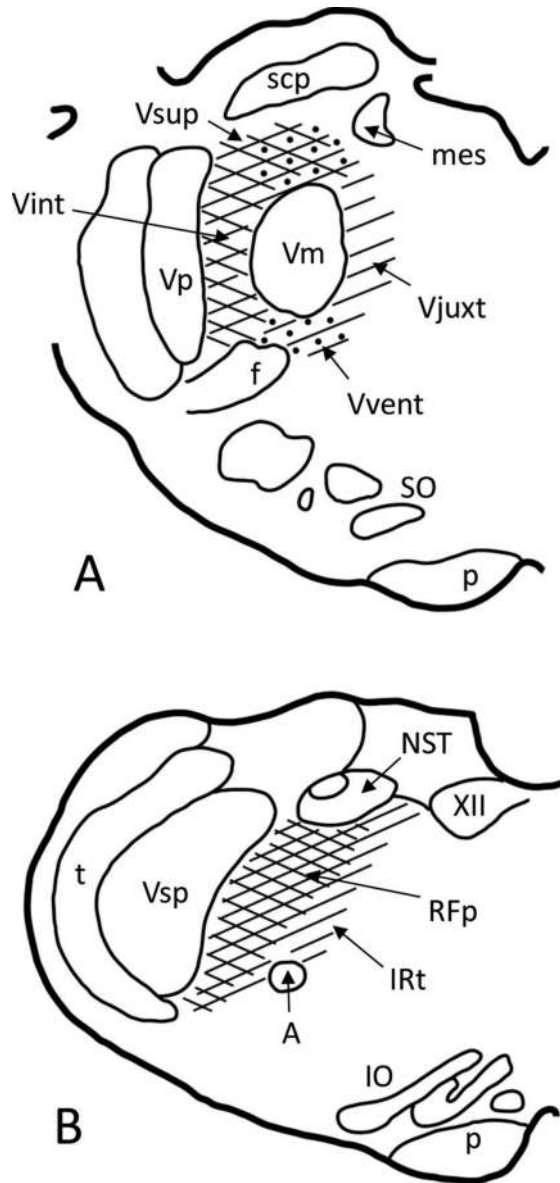

Figure 2. Schematic diagrams of the pons (A) and medulla oblongata (B) depicting the Vm-premotor neuron pools of the rat. A, ambiguus nucleus; f, facial nerve; IO, inferior olivary complex; IRt, intermediate reticular nucleus; mes, mesencephalic trigeminal tract; NST, nucleus of the solitary tract; p, pyramis; RFp, parvocellular reticular formation; scp, superior cerebellar peduncle; SO, superior olivary complex; t, spinal trigeminal tract; Vint, intertrigeminal area; Vjuxt, juxtatrigenimal area; Vm, motor trigeminal nucleus; Vsp, spinal trigeminal nucleus; Vsup, supratrigeminal area; Vvent, reticular formation ventral to the Vm; Vp, principal trigeminal nucleus; XII, hypoglossal nucleus.

orofacial motor nuclei (Vm and VII, Vm and XII, or VII and XII) [17]. These data suggest that RFp neurons may serve to synchronize not only the activity of Vm, VII, or XII motoneurons on both sides but also the activity of Vm and VII, Vm and XII, or VII and XII motoneurons. However, it remains unknown whether or not single premotor neurons project by way of axon collaterals simultaneously to all orofacial motor nuclei.

5. Descending pathways from the amygdala to the Vm

Stimulation of the amygdala results in changes of autonomic functions and emotional behaviors, and is known to have an effect on orofacial movements, particularly jaw movement [18]. As noted above, jaw movement is controlled by Vm motoneurons. Control pathways from the amygdala to the Vm have been examined using anterograde and/or retrograde axonal tracing in anatomical studies. Such axonal tracing combined with immunohistochemistry or *in situ* hybridization has provided the means of further investigation of neurotransmitters, their receptors and transporters in the neural circuits.

5.1. Neuroanatomical organization

5.1.1. CeA-RFp-Vm pathway

The direct CeA-Vm pathway was suggested by Mascaro et al. [19], who observed retrograde-labeled neurons in the CeA after Fluoro-gold (FG) injection into the Vm. On the other hand, anterograde-tracing studies have shown that biotinylated dextran amine (BDA)-labeled fibers with bouton-like varicosities are distributed around the Vm but not within the Vm after BDA injection into the CeA, suggesting a low probability of the existence of a direct CeA-Vm pathway [20, 21].

However, the existence of a disynaptic pathway from the CeA to the Vm via the supratrigeminal area [22] or via the lateral reticular formation of the pons [23] has been confirmed by anatomical studies using a combined degeneration and horseradish peroxidase method. A physiological study [24] also produced data supporting the existence of disynaptic inputs from the amygdala to the Vm mediated by the supratrigeminal area. It has also been established that descending projection fibers from the CeA are distributed in the RFp of the lower brainstem [25–27]. Furthermore, the RFp of the medulla oblongata contains many premotor neurons that project directly to the Vm [9–11, 28, 29]. Taken together, these data make it likely that the CeA also exerts its influences on the regulation of jaw movement through the disynaptic pathway from the CeA to the Vm via the RFp of the medulla oblongata.

We confirmed the existence of a CeA-RFp-Vm pathway by using a combination of anterograde- and retrograde-tracing techniques [20]. When ipsilateral injections of BDA into the CeA and of cholera toxin B subunit (CTb) into the Vm were made in a rat, a significant overlap of BDA-labeled axons and CTb-labeled neurons was found in the RFp region just ventral to the nucleus of the solitary tract and medial to the spinal trigeminal nucleus throughout the caudal-most part of the pons and the rostral half of the medulla oblongata (**Figure 3**).

When the neuropil of the RFp was viewed under an electron microscope, BDA-labeled axons showed symmetrical synaptic contacts predominantly with dendrites and additionally with somata of the RFp neurons, some of which were labeled with CTb.

5.1.2. CeA-PLH-RFp-Vm pathway

Anterograde-tracing studies with *Phaseolus vulgaris*-leucoagglutinin [30, 31] and BDA [32] indicate that the posterior lateral hypothalamus (PLH) receives a dense projection from the CeA; the PLH is just medial to the subthalamic nucleus and has been identified as the parasubthalamic nucleus by Wang and Zang [33].

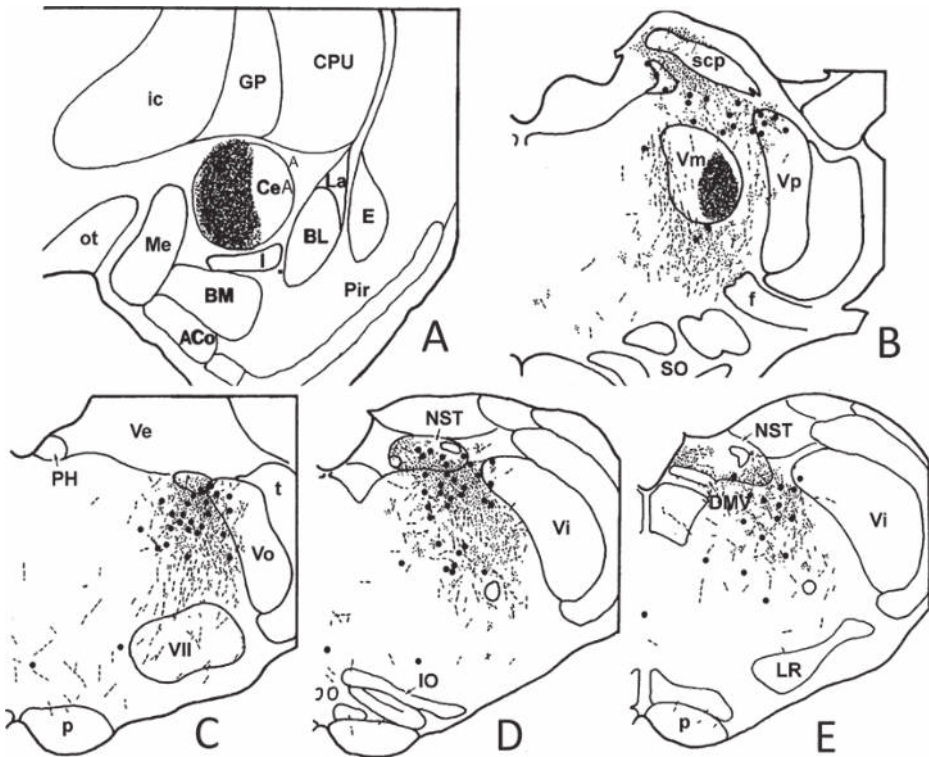

Figure 3. Projection drawings showing the sites of BDA injection into the CeA (shaded area in A) and CTb injection into the Vm (shaded area in B), and resulting anterograde and retrograde labeling in the lower brainstem ipsilateral to the injection sites (B–E, rostral to caudal). BDA-labeled fibers and terminals are presented by fine lines and fine dots, respectively. CTb-labeled cell bodies are presented by filled circles, each of which represents approximately two labeled cell bodies. ACo, anterior cortical amygdaloid nucleus; BL, basolateral amygdaloid nucleus; BM, basomedial amygdaloid nucleus; CPU, caudate-putamen; GP, globus pallidus; CeA, central amygdaloid nucleus; DMV, dorsal motor nucleus of the vagus nerve; E, endopiriform nucleus; Me, medial amygdaloid nucleus; I, interstitial amygdaloid nucleus; ic, internal capsule; La, lateral amygdaloid nucleus; LR, lateral reticular nucleus; ot, optic tract; PH, prepositus hypoglossal nucleus; Pir, piriform cortex; Ve, vestibular nucleus; Vi, interpolary subnucleus of the spinal trigeminal nucleus; Vo, oral subnucleus of the spinal trigeminal nucleus; VII, facial nucleus. Other abbreviations are as in **Figure 2** (modified from Yasui et al. [20]).

Stimulation of the LHA region including the PLH is known to promote not only a jaw-closing reflex [34] but also the activity of the masseter muscle [35]. However, there have been no anterograde-tracing studies, which demonstrate the direct hypothalamo-Vm projection, though the existence of peptidergic projections from the LHA to the Vm has been reported, as is described below. Further, after BDA injection into the PLH, we observed only some passing BDA-labeled fibers without bouton-like varicosities within the Vm, counter-indicative of the existence of a direct PLH-Vm pathway [36].

Within the hypothalamus, the majority of RFP-projecting neurons are localized in the PLH region [36]. Although Mascaro et al. [19] observed a large number of FG-labeled neurons in the PLH region after FG injection into the Vm, there is a high possibility that these labeled neurons project to the reticular formation around the Vm, but not to the Vm. A combined anterograde- and retrograde-tracing techniques have shown the prominent overlap of distribution of PLH fibers and Vm-premotor neurons in the RFP region just ventral to the nucleus of the solitary tract and medial to the spinal trigeminal nucleus (**Figure 4**); further, the PLH axon terminals make asymmetrical synaptic contact with dendrites and somata of the RFP neurons, some of which were labeled with CTb injected into the Vm [36]. The results of these recent and earlier studies raise the possibility of the existence of a CeA-PLH-RFP-Vm pathway, and that RFP-projecting PLH neurons are under the direct influence of the CeA.

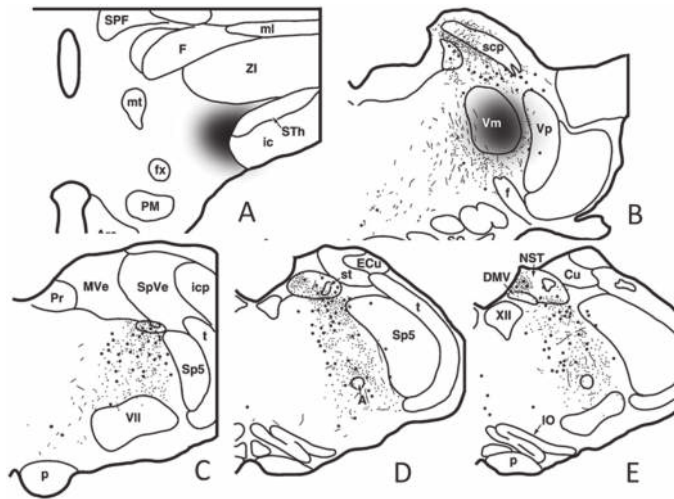

Figure 4. Line drawings showing the sites of BDA injection into the PLH (shaded area in A) and CTb injection into the Vm (shaded area in B), and resulting anterograde and retrograde labeling in the lower brainstem ipsilateral to the injection sites (B–E, rostral to caudal). BDA-labeled fibers and terminals are presented by fine lines and fine dots, respectively. CTb-labeled cell bodies are presented by filled circles, each of which represents approximately two labeled cell bodies. Arc, arcuate nucleus; Cu, cuneate nucleus; ECU, external cuneate nucleus; F, nucleus of the fields of Forel; fx, fornix; icp, inferior cerebellar peduncle; ml, medial lemniscus; mt, mammillothalamic tract; MVe, medial vestibular nucleus; PM, premammillary nucleus; Pr, prepositus hypoglossal nucleus; SPF, subparafacicular nucleus; SpVe, spinal vestibular nucleus; Sp5, spinal trigeminal nucleus; st, solitary tract; STh, subthalamic nucleus; ZI, zona incerta; Other abbreviations are as in **Figures 2** and **3** (modified from Notsu et al. [36]).

5.1.3. CeA-SN/RRF-RFp-Vm pathways

A dense projection from the CeA has been observed in the lateral part of the substantia nigra (SN) pars compacta as well as in the SN pars lateralis, a part of the SN pars reticulata [37]. Both the lateral part of the SN pars reticulata and the lateral part of the SN pars compacta are known to contain neurons projecting to the reticular region around the Vm [38], as well as to the RFp of the medulla oblongata [39]. These data suggest the existence of a disynaptic pathway from the CeA to the RFp via the SN, which is responsible for the control of jaw movements.

CeA fibers are also densely distributed in the lateral portion of the retrorubral field (RRF) [37, 40] which is an area dorsal and caudal to the SN and is believed to be involved in orofacial motor function [41, 42]. Additionally, the RRF region contains a population of neurons that project their axons to the pontomedullary RFp [43, 44]. Taken together, these data indicate that the output signals from the CeA have a direct influence on the RRF-RFp pathway for the control of orofacial movements including the jaw movement. Following ipsilateral injections of BDA into the CeA and FG into the RFp, we noted a prominent overlap of the distribution of BDA-labeled fibers and FG-labeled neurons in the lateral part of the RRF ipsilateral to the injection sites, where BDA-labeled axon terminals make symmetrical synapses with somata and dendrites of the FG-labeled neurons [45] (**Figure 5**).

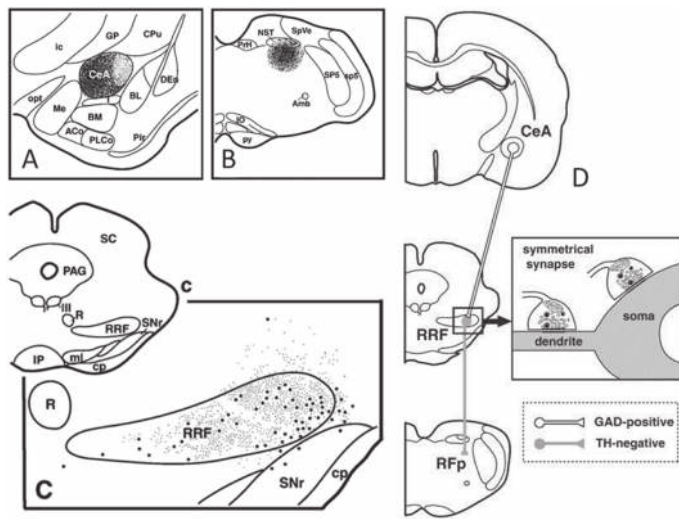

Figure 5. Line drawings illustrating the sites of BDA injection into the CeA (shaded area in A) and FG injection into the RFp (shaded area in B), and resulting distributions of BDA-labeled terminals (small dots) and FG-labeled neurons (large dots) in the RRF region (C). RRF region in the midbrain section (c) is enlarged in C. In D, the synaptic organization between CeA axon terminals and RFp-projecting RRF neurons is illustrated. Amb, ambiguous nucleus; cp, cerebral peduncle; Den, dorsal endopiriform nucleus; IP, interpeduncular nucleus; ml, medial lemniscus; opt, optic tract; PAG, periaqueductal gray; PLCo, posterolateral cortical amygdaloid nucleus; PrH, prepositus hypoglossal nucleus; py, pyramis; R, red nucleus; RRF, retrorubral field; SC, superior colliculus; SNr, substantia nigra pars reticulata; SP5, spinal trigeminal nucleus; sp5, spinal trigeminal tract; TH, tyrosine hydroxylase; III, oculomotor nucleus. Other abbreviations are as in **Figures 2–4** (modified from Tsumori et al. [45]).

5.1.4. CeA-Vmes-Vm pathway

The Vmes contains somata of primary afferent neurons whose peripheral processes are distributed in the muscle spindles of jaw-closing muscles and mechanoreceptors within the periodontal ligaments. According to Nomura and Mizuno [13], Vmes neurons that conduct jaw-closing muscle afferent are distributed throughout the whole rostrocaudal extent of the Vmes, while Vmes neurons, which conduct periodontal receptor afferent, are located mainly in the caudal part of the Vmes. The central processes of Vmes neurons terminate mainly in the Vm and additionally in the premotor reticular formation.

Recently, anterograde-tracing studies [21, 46] reported that the CeA sends projection fibers to the Vmes where CeA axonal varicosities are in close apposition to the somata of Vmes neurons. Further, Shirasu et al. [47] have shown that anterograde-labeled terminal buttons on Vmes neuronal somata are more abundantly present in the caudal than in the rostral Vmes after a wheat germ agglutinin conjugated to horseradish peroxidase injection into the CeA. The same study also indicated that a portion of these terminal buttons form axo-somatic synapses with Vmes neurons, and that the CeA has direct projections to the Me5, suggesting that the amygdala regulates bite strength by modifying neuronal activity in the Vmes.

5.2. Neurochemical organization

5.2.1. Neurotransmitter of CeA neurons

In situ hybridization studies demonstrated that almost all the CeA neurons are positive for glutamic acid decarboxylase (GAD) 65 mRNA [48] and GAD67 mRNA [49] but not for vesicular glutamate transporter (VGLUT) 1 mRNA [48] and VGLUT2 mRNA [48, 49] (**Figure 6**); GAD is an enzyme that converts glutamate to GABA and is utilized as a marker for GABAergic neurons, while VGLUT1 and VGLUT2 are used as markers for glutamatergic neurons. In an earlier study, we demonstrated that most CeA axon terminals in the RRF are immunoreactive for GAD [45]. Such GABAergic CeA axon terminals have been observed in other brainstem regions including the parabrachial nucleus [50] and nucleus of the solitary tract [51, 52], as well as in the forebrain regions including the parastrial nucleus [53] and LHA [32, 54]. These findings are all indicative of CeA projection neurons being GABAergic.

5.2.2. Neurotransmitter of hypothalamic neurons

Hypothalamic neurons labeled with CTb injected into the Vm region display glutamate-like immunoreactivity [55]. VGLUT is considered to represent the most specific marker for neurons using glutamate as a transmitter [56], and LHA neurons express predominantly VGLUT2 mRNA and additionally VGLUT1 mRNA [57]. It has also been reported that axon terminals with glutamate immunoreactivity [58–60] or with VGLUT2 immunoreactivity [61] make asymmetrical synapses with their target structures. We previously demonstrated that PLH axon terminals with VGLUT2 immunoreactivity make asymmetrical synapses with RFP neurons, suggesting that glutamatergic PLH neurons exert excitatory influence upon RFP neurons [36].

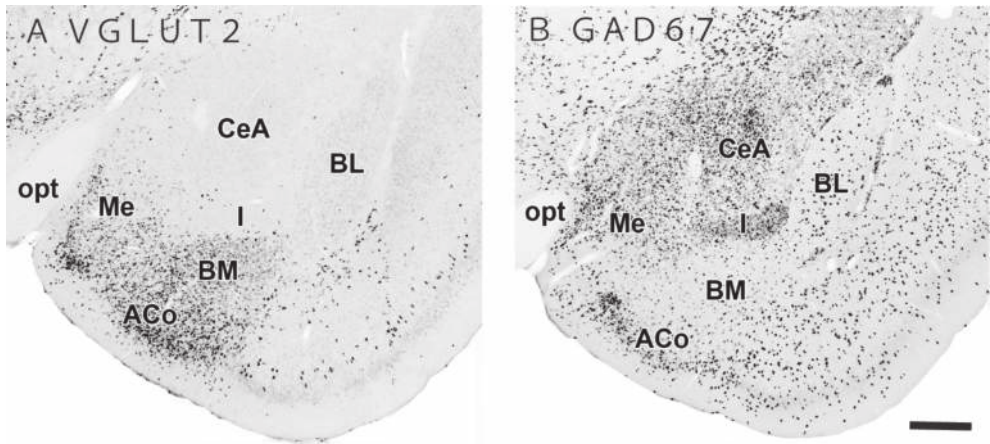

Figure 6. Photomicrographs showing the *in situ* hybridization staining for VGLUT2 mRNA (A) and GAD67 mRNA (B) in the amygdaloida. Scale bar = 500 μ m (modified from Oka et al. [49]).

By using retrograde tracing in combination with immunohistochemical methods, studies [62, 63] have demonstrated at the light microscopic level that orexin (ORX)-containing hypothalamic fibers are in contact with Vm motoneurons, though there are only sparse ORXergic fibers in the Vm. More recently, Mascaro et al. [46] documented that ORXergic fibers are distributed in the Vm and that approximately one-third of the LHA neurons projecting axons to the Vm are immunoreactive for ORX. McGregor et al. [55], who also found ORXergic Vm-premotor neurons in the LHA, further indicated that Vm-premotor neurons in the LHA as well as in the perifornical nucleus are immunoreactive for melanin-concentrating hormone (MCH). Saito et al. [64] reported that MCH-immunoreactive fibers are distributed in the Vm where many neurons express MCH receptor mRNA. Interestingly, our previous study [54] indicated that GABAergic CeA neurons innervate MCH- and ORX-containing hypothalamic neurons.

Taken together, these data suggest that the CeA plays a role in the control of neuronal activity in the Vm by means of its inhibitory influence upon MCH- and ORX-containing hypothalamic neurons.

5.2.3. Neurotransmitter of SN and RRF neurons

The SN has two distinct parts: the SN pars compacta and the SN pars reticulata. Dopamine neurons are found predominantly in the SN pars compacta, while the pars reticulata is populated largely by GABA neurons. A densely packed group of dopaminergic neurons in the SN pars compacta is known as the A9 dopamine cell group. The RRF also contains many dopaminergic neurons referred to as the A8 dopamine cell group. SN neurons projecting to the brainstem regions, such as the inferior colliculus [65] and reticular formation around the Vm [38], are not immunoreactive for tyrosine hydroxylase (TH), which catalyzes the rate-limiting

step in the synthesis of catecholamine. We demonstrated in a previous study that RRF neurons projecting to the RfP are immunonegative for TH [45].

Such findings suggest that both the SN and RRF neurons sending their axons to the lower brainstem are non-dopaminergic and most likely GABAergic [66]. Future studies combining retrograde tract-tracing with immunolabeling for GABA or GAD, or with *in situ* hybridization for GAD mRNA, should help to demonstrate this.

5.2.4. Neurotransmitter of RfP neurons

As for neurotransmitter phenotypes, the RfP is heterogeneous and contains glutamatergic, GABAergic, cholinergic, and nitrergic neurons [67]. According to Pang et al. [68], VGLUT2-immunoreactive axon terminals, distributed in both the Vm-dl and the Vm-vl, originate from Vm-premotor neurons in the reticular formation such as the reticular region ventral to the Vm and RfP, as well as in the sensory trigeminal nuclei. They also observed VGLUT1-immunoreactive terminals within the Vm-dl only and demonstrated that these terminals originate from the reticular region ventral to the Vm as well as from the Vmes. Travers et al. [67] noted that approximately half of the Vm-premotor neurons in the RfP and IRt are immunoreactive for VGLUT2.

On the other hand, it has been reported that inhibitory Vm-premotor neurons immunoreactive for GAD or glycine are also distributed in the RfP [69]. In another study, Travers et al. [66] indicated that a quarter of the Vm-premotor neurons in the RfP and IRt are immunoreactive for GAD65/67, and that relatively few Vm-premotor neurons in the RfP and IRt are either nitrergic or cholinergic.

5.2.5. Neurotransmitter of Vmes neurons

It is known that Vmes neurons are glutaminergic [70, 71]. Also, a recent study [72] demonstrated that VGLUT1 mRNA is expressed in the cell bodies of Vmes neurons and showed VGLUT1 immunoreactivity in both the central axon terminals and peripheral sensory endings of Vmes neurons. Pang et al. [73] further noted that VGLUT1-immunoreactive terminals observed in the Vm-dl but not in the Vm-vl come from primary afferent Vmes neurons, whereas the VGLUT2-immunoreactive terminals observed in both the Vm-dl and the Vm-vl come from Vm-premotor neurons, as previously stated.

6. Conclusion

The neuroanatomical and neurochemical organization of the control pathways from the CeA to the Vm is summarized in **Figure 7**. The CeA exerts its influence upon Vm motoneurons through its direct and indirect projections to Vm-premotor neurons, including RfP and Vmes neurons. These projections are responsible for the control of specific emotional motor activities of the trigeminal system. The RfP is a major premotor neuron pool not only for the Vm

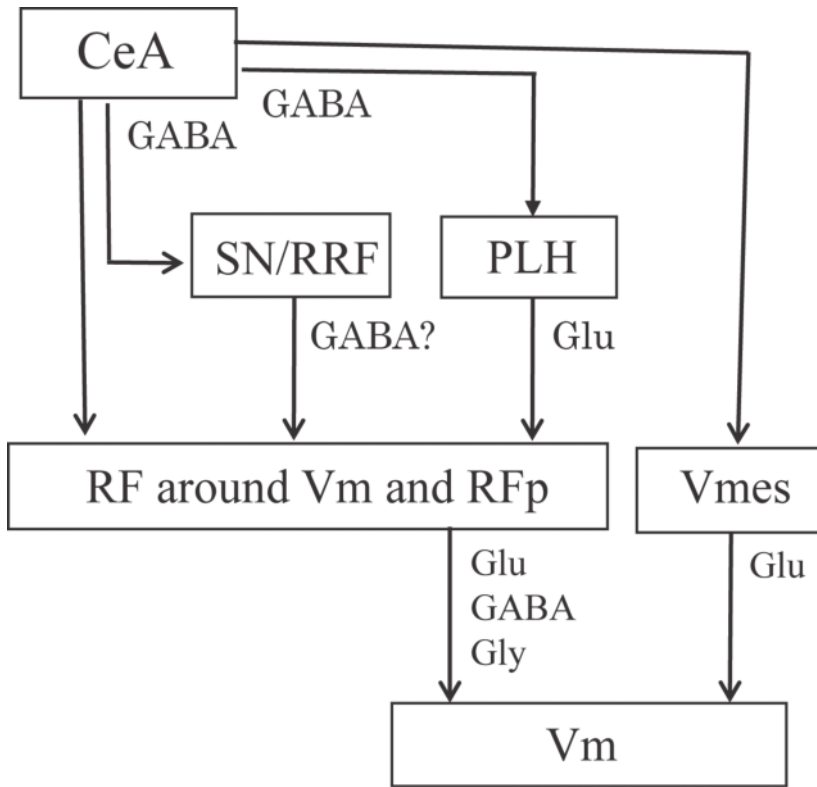

Figure 7. Summary diagram showing the control pathways from the CeA to the Vm. The CeA controls jaw movements through its direct projections to Vm-premotor neurons in the reticular formation (RF) around the Vm in the pons, RFp in the pontomedullary and medullary brainstem, as well as in the Vmes. In addition, the CeA control jaw movements through its indirect projections to these premotor neuron pools via the SN/RRF or via the PLH. The neurotransmitter(s) used in each pathway are also indicated. Glu, glutamate; Gly, glycine.

but also for the VII and XII. It is therefore likely that the amygdala controls orofacial movements during various emotional behaviors through its projections to the orofacial motor nuclei relayed by the RFp.

Acknowledgements

The authors are grateful for the support from Drs. R. Fujimoto, K. Fujita, T. Goeku, M. Kuzushima, T. Mukai, Y. Munenaga, T. Sakurai, Y. Sakurai, H. Taguchi, K. Tanaka, K. Urashima, H. Yamaoka, S. Yamazaki, and K. Yoshida. This study was partly supported by a Grant-in-Aid for Scientific Research (C) from the Ministry of Education, Science, Sports, and Culture of Japan.

Author details

Yukihiko Yasui

Address all correspondence to: yyasui@med.shimane-u.ac.jp

Department of Anatomy and Morphological Neuroscience, Shimane University School of Medicine, Izumo, Japan

References

- [1] Rajmohan V, Mohandas E. The limbic system. *Indian J. Psych.* 2007;49:132-139.
- [2] LeDoux JE. The neurobiology of emotion. In: LeDoux JE, Hirst W, editors. *Mind and Brain*. New York, NY: Cambridge University Press; 1986. pp. 301-354.
- [3] LeDoux JE, Emotion. In: Mountcastle VB, editor. *Handbook of Physiology, Section I, The Nervous System, Vol 5, Part 1*. Washington: American Physiology Society; 1987. pp. 419-459.
- [4] Holstege G. The emotional motor system. *Eur. J. Morphol.* 1992;30:67-79.
- [5] Holstege G. The emotional motor system and micturition control. *Neurol. Urodyn.* 2010; 29:42-48.
- [6] Holstege G. Descending motor pathways and the spinal motor system: limbic and non-limbic components. *Prog. Brain Res.* 1991;87:307-421.
- [7] Mizuno N, Konishi A, Sato M. Localization of masticatory motoneurons in the cat and rat by means of retrograde axonal transport of horseradish peroxidase. *J. Comp. Neurol.* 1975;164:105-115.
- [8] Sasamoto K. Motor nuclear representation of masticatory muscles in the rat. *Jpn. J. Physiol.* 1979;29:739-747.
- [9] Travers JB, Norgren R. Afferent projections to the oral motor nuclei in the rat. *J. Comp. Neurol.* 1983;220:280-298.
- [10] Li YQ, Takada M, Kaneko T, Mizuno N. Premotor neurons for trigeminal motor nucleus neurons innervating the jaw-closing and jaw-opening muscles: differential distribution in the lower brainstem of the rat. *J. Comp. Neurol.* 1995;356:563-579.
- [11] Ter Horst GJ, Copray JCVM, Liem RSB, Van Willigen JD. Projections from the rostral parvicellular reticular formation to pontine and medullary nuclei in the rat: involvement in autonomic regulation and orofacial motor control. *Neuroscience* 1991;40:735-758.
- [12] Jerge CR. Organization and function of the trigeminal mesencephalic nucleus. *J. Neurophysiol.* 1963;26:379-392.

- [13] Nomura S, Mizuno N. Differential distribution of cell bodies and central axons of mesencephalic trigeminal nucleus neurons supplying the jaw-closing muscles and periodontal tissue: a transganglionic tracer study in the cat. *Brain Res.* 1985;359:311-319.
- [14] Liem RS, Copray JC, van Willigen JD. Ultrastructure of the rat mesencephalic trigeminal nucleus. *Acta Anat.* 1991;140:112-119.
- [15] Luo P, Li J. Monosynaptic connections between neurons of trigeminal mesencephalic nucleus and jaw-closing motoneurons in the rat: an intracellular horseradish peroxidase labeling study. *Brain Res.* 1991;559:267-275.
- [16] Li YQ, Takada M, Mizuno N. Identification of premotor interneurons which project bilaterally to the trigeminal motor, facial or hypoglossal nuclei: a fluorescent retrograde double-labeling study in the rat. *Brain Res.* 1993;611:160-164.
- [17] Li YQ, Takada M, Mizuno N. Premotor neurons projecting simultaneously to two orofacial motor nuclei by sending their branched axons. A study with a fluorescent retrograde double-labeling technique in the rat. *Neurosci. Lett.* 1993;152:29-32.
- [18] Kawamura Y, Tsukamoto S. Analysis of jaw movements from the cortical jaw motor area and amygdala. *Jpn. J. Physiol.* 1960;10:471-488.
- [19] Mascaro MB, Bittencourt JC, Casatti CA, Elias CF. Alternative pathways for catecholamine action in oral motor control. *Neurosci. Lett.* 2005;386:34-39.
- [20] Yasui Y, Tsumori T, Oka T, Yokota S. Amygdaloid axon terminals are in contact with trigeminal premotor neurons in the parvicellular reticular formation of the rat medulla oblongata. *Brain Res.* 2004;1016:129-134.
- [21] Lazarov NE, Usunoff KG, Schmitt O, Itzev DE, Rolfs A, Wree A. Amygdalotrigeminal projection in the rat: An anterograde tracing study. *Ann. Anat.* 2011;193:118-126.
- [22] Takeuchi Y, Satoda T, Matsushima R. Amygdaloid projections to the commissural interneurons for masticatory motoneurons. *Brain Res. Bull.* 1988;21:123-127.
- [23] Takeuchi Y, Satoda T, Tashiro T, Matsushima R, Uemura-Sumi M. Amygdaloid pathway to the trigeminal motor nucleus via the pontine reticular formation in the rat. *Brain Res. Bull.* 1988;21:829-833.
- [24] Ohta M, Moriyama Y. Supratrigeminal neurons mediate shortest, disynaptic pathway from the central amygdaloid nucleus to the contralateral trigeminal motoneurons in the rat. *Comp. Biochem. Physiol.* 1986;83A:633-641.
- [25] Hopkins DA, Holstege G. Amygdaloid projections to the mesencephalon, pons and medulla oblongata in the cat. *Exp. Brain Res.* 1978;32:529-547.
- [26] Krettek JE, Price JL. Amygdaloid projections to subcortical structures within the basal forebrain and brainstem in the rat and cat. *J. Comp. Neurol.* 1978;178:225-254.
- [27] Price JL, Amaral DG. An autoradiographic study of the projections of the central nucleus of the monkey amygdala. *J. Neurosci.* 1981;1:1242-1259.

- [28] Mogoseanu D, Smith AD, Bolam JP. Monosynaptic innervation of trigeminal motor neurons involved in mastication by neurons of the parvicellular reticular formation. *J. Comp. Neurol.* 1993;336:53-65.
- [29] Yasui Y, Tsumori T, Ono K, Kishi T. Nigral axon terminals are in contact with parvicellular reticular neurons which project to the motor trigeminal nucleus in the rat. *Brain Res.* 1997;775:219-224.
- [30] Bourgeois L, Gauriau C, Bernard JF. Projections from the nociceptive area of the central nucleus of the amygdala to the forebrain: a PHA-L study in the rat. *Eur. J. Neurosci.* 2001;14: 229-255.
- [31] Tsumori T, Yokota S, Kishi T, Qin Y, Oka T, Yasui Y. Insular cortical and amygdaloid fibers are in contact with posterolateral hypothalamic neurons projecting to the nucleus of the solitary tract in the rat. *Brain Res.* 2006;1070:139-144.
- [32] Tsumori T, Yokota S, Qin Y, Oka T, Yasui Y. A light and electron microscopic analysis of the convergent insular cortical and amygdaloid projections to the posterior lateral hypothalamus in the rat, with special reference to cardiovascular function. *Neurosci. Res.* 2006;56:261-269.
- [33] Wang PY, Zang FC. Outline and atlas of learning rat brain slices. China: Westnorth University Press, China. 1995.
- [34] Landgren S, Olsson KA. The effect of electrical stimulation in the hypothalamus on the monosynaptic jaw closing and the disynaptic jaw opening reflexes in the cat. *Exp. Brain Res.* 1980;39:389-400.
- [35] Weiner S, Shaikh MB, Siegel A. Electromyographic activity in the masseter muscle resulting from stimulation of hypothalamic behavioral sites in the cat. *J. Orofac. Pain* 1993;7:370-377.
- [36] Notsu K, Tsumori T, Yokota S, Sekine J, Yasui Y. Posterior lateral hypothalamic axon terminals are in contact with trigeminal premotor neurons in the parvicellular reticular formation of the rat medulla oblongata. *Brain Res.* 2008;1244:71-81.
- [37] Gonzales C, Chesselet MF. Amygdalonigral pathway: an anterograde study in the rat with Phaseolus vulgaris leucoagglutinin (PHA-L). *J. Comp. Neurol.* 1990;297:182-200.
- [38] Yasui Y, Nakano K, Nakagawa Y, Kayahara T, Shiroyama T, Mizuno N. Non-dopaminergic neurons in the substantia nigra project to the reticular formation around the trigeminal motor nucleus in the rat. *Brain Res.* 1992;585:361-366.
- [39] Yasui Y, Tsumori T, Ando A, Domoto T. Demonstration of axon collateral projections from the substantia nigra pars reticulata to the superior colliculus and the parvicellular reticular formation in the rat. *Brain Res.* 1995;674:122-126.
- [40] Wallace DM, Magnuson DJ, Gray TS. Organization of amygdaloid projections to brain-stem dopaminergic, noradrenergic, and adrenergic cell groups in the rat. *Brain Res. Bull.* 1992;28:447-54.

- [41] Arts MP, Bemelmans FF, Cools AR. Role of the retrorubral nucleus in striatally elicited orofacial dyskinesia in cats: effects of muscimol and bicuculline. *Psychopharmacology (Berl)*. 1998;140:150-156.
- [42] Uchida T, Adachi K, Fujita S, Lee J, Gionhaku N, Cools AR, Koshikawa N. Role of GABA(A) receptors in the retrorubral field and ventral pallidum in rat jaw movements elicited by dopaminergic stimulation of the nucleus accumbens shell. *Eur. J. Pharmacol.* 2005;510:39-47.
- [43] von Krosigk M, Smith AD. Descending projections from the substantia nigra and retrorubral field to the medullary and pontomedullary reticular formation. *Eur. J. Neurosci.* 1991;3:260-273.
- [44] von Krosigk M, Smith Y, Bolam JP, Smith AD. Synaptic organization of GABAergic inputs from the striatum and the globus pallidus onto neurons in the substantia nigra and retrorubral field which project to the medullary reticular formation. *Neuroscience.* 1992;50:531-549.
- [45] Tsumori T, Qin Y, Yokota S, Niu JG, Yasui Y. Central amygdaloid axon terminals are in contact with retrorubral field neurons that project to the parvicellular reticular formation of the medulla oblongata in the rat. *Brain Res.* 2009;1306:18-28.
- [46] Mascaro MB, Prosdócimi FC, Bittencourt JC, Elias CF. Forebrain projections to brainstem nuclei involved in the control of mandibular movements in rats. *Eur. J. Oral Sci.* 2009;117:676-684.
- [47] Shirasu M, Takahashi T, Yamamoto T, Itoh K, Sato S, Nakamura H. Direct projections from the central amygdaloid nucleus to the mesencephalic trigeminal nucleus in rats. *Brain Res.* 2011;1400:19-30.
- [48] Poulin JF, Castonguay-Lebel Z, Laforest S, Drolet G. Enkephalin co-expression with classic neurotransmitters in the amygdaloid complex of the rat. *J. Comp. Neurol.* 2008;506:943-959.
- [49] Oka T, Tsumori T, Yokota S, Yasui Y. Neuroanatomical and neurochemical organization of projections from the central amygdaloid nucleus to the nucleus retroambiguus via the periaqueductal gray in the rat. *Neurosci. Res.* 2008;62:286-298.
- [50] Jia HG, Zhang GY, Wan Q. A GABAergic projection from the central nucleus of the amygdala to the parabrachial nucleus: an ultrastructural study of anterograde tracing in combination with post-embedding immunocytochemistry in the rat. *Neurosci. Lett.* 2005;382:153-157.
- [51] Jia HG, Rao Z-R, Shi J-W. Evidence of gamma-aminobutyric acidergic control over the catecholaminergic projection from the medulla oblongata to the central nucleus of the amygdala. *J. Comp. Neurol.* 1997;381:262-281.
- [52] Saha S, Batten TF, Henderson Z. A GABAergic projection from the central nucleus of the amygdala to the nucleus of the solitary tract: a combined anterograde tracing and electron microscopic immunohistochemical study. *Neuroscience.* 2000;99:613-26.

- [53] Tsubouchi K, Tsumori T, Yokota S, Okunishi H, Yasui Y. A disynaptic pathway from the central amygdaloid nucleus to the paraventricular hypothalamic nucleus via the paraventricular nucleus in the rat. *Neurosci. Res.* 2007;59:390-398.
- [54] Nakamura S, Tsumori T, Yokota S, Oka T, Yasui Y. Amygdaloid axons innervate melanin-concentrating hormone- and orexin-containing neurons in the mouse lateral hypothalamus. *Brain Res.* 2009;1278:66-74.
- [55] McGregor R, Damián A, Fabbiani G, Torterolo P, Pose I, Chase M, Morales FR. Direct hypothalamic innervation of the trigeminal motor nucleus: a retrograde tracer study. *Neuroscience.* 2005;136:1073-1081.
- [56] Kaneko T, Fujiyama F. Complementary distribution of vesicular glutamate transporters in the central nervous system. *Neurosci. Res.* 2002;42:243-250.
- [57] Ziegler DR, Cullinan WE, Herman JP. Distribution of vesicular glutamate transporter mRNA in rat hypothalamus. *J. Comp. Neurol.* 2002;448:217-229.
- [58] Clarke NP, Bolam JP, Bevan MD. Glutamate-enriched inputs from the mesopontine tegmentum to the entopeduncular nucleus in the rat. *Eur. J. Neurosci.* 1996;8:1363-1376.
- [59] Gundersen V, Ottersen OP, Storm-Mathisen J. Selective excitatory amino acid uptake in glutamatergic nerve terminals and in glia in the rat striatum: quantitative electron microscopic immunocytochemistry of exogenous (D)-aspartate and endogenous glutamate and GABA. *Eur. J. Neurosci.* 1996;8:758-765.
- [60] Tai Q, Goshgarian HG. Ultrastructural quantitative analysis of glutamatergic and GABAergic synaptic terminals in the phrenic nucleus after spinal cord injury. *J. Comp. Neurol.* 1996;372:343-355.
- [61] Fujiyama F, Hioki H, Tomioka R, Taki K, Tamamaki N, Nomura S, Okamoto K, Kaneko T. Changes of immunocytochemical localization of vesicular glutamate transporters in the rat visual system after the retinofugal denervation. *J. Comp. Neurol.* 2003;465:234-249.
- [62] Fung SJ, Yamuy J, Sampogna S, Morales FR, Chase MH. Hypocretin (orexin) input to trigeminal and hypoglossal motoneurons in the cat: a double-labeling immunohistochemical study. *Brain Res.* 2001;903:257-262.
- [63] Zhang J, Luo P. Orexin B immunoreactive fibers and terminals innervate the sensory and motor neurons of jaw-elevator muscles in the rat. *Synapse.* 2002;44:106-110.
- [64] Saito Y, Cheng M, Leslie FM, Civelli O. Expression of the melanin-concentrating hormone (MCH) receptor mRNA in the rat brain. *J. Comp. Neurol.* 2001;435:26-40.
- [65] Yasui Y, Nakano K, Kayahara T, Mizuno N. Non-dopaminergic projections from the substantia nigra pars lateralis to the inferior colliculus in the rat. *Brain Res.* 1991;559:139-144.
- [66] Mugnaini E, Oertel WH. Atlas of the distribution of GABAergic neurons and terminals in the rat as revealed by GAD immunoreactivity. In: Björklund A and Hökfelt T, editors. *Handbook of Chemical Neuroanatomy: GABA and Neuropeptides in the CNS, Part 1 Vol. 4*, Elsevier, Amsterdam, 1985. pp. 436-595.

- [67] Travers JB, Yoo JE, Chandran R, Herman K, Travers SP. Neurotransmitter phenotypes of intermediate zone reticular formation projections to the motor trigeminal and hypoglossal nuclei in the rat. *J. Comp. Neurol.* 2005;488:28-47.
- [68] Pang YW, Ge SN, Nakamura KC, Li JL, Xiong KH, Kaneko T, Mizuno N. Axon terminals expressing vesicular glutamate transporter VGLUT1 or VGLUT2 within the trigeminal motor nucleus of the rat: origins and distribution patterns. *J. Comp. Neurol.* 2009;512:595-612.
- [69] Li YQ, Takada M, Kaneko T, Mizuno N. GABAergic and glycinergic neurons projecting to the trigeminal motor nucleus: a double labeling study in the rat. *J. Comp. Neurol.* 1996;373:498-510.
- [70] Kaneko T¹, Itoh K, Shigemoto R, Mizuno N. Glutaminase-like immunoreactivity in the lower brainstem and cerebellum of the adult rat. *Neuroscience* 1989;32:79-98.
- [71] Chen P, Li J, Li J, Mizuno N. Glutamic acid decarboxylase-like immunoreactive axon terminals in synaptic contact with mesencephalic trigeminal nucleus neurons in the rat. *Neurosci. Lett.* 2001;298:167-170.
- [72] Pang YW, Li JL, Nakamura K, Wu S, Kaneko T, Mizuno N. Expression of vesicular glutamate transporter 1 immunoreactivity in peripheral and central endings of trigeminal mesencephalic nucleus neurons in the rat. *J. Comp. Neurol.* 2006;498:129-141.
- [73] Pang YW, Ge SN, Nakamura KC, Li JL, Xiong KH, Kaneko T, Mizuno N. Axon terminals expressing vesicular glutamate transporter VGLUT1 or VGLUT2 within the trigeminal motor nucleus of the rat: origins and distribution patterns. *J. Comp. Neurol.* 2009;512:595-612.

