Cells and Organs on Chip—A Revolutionary Platform for Biomedicine

Preeti Nigam Joshi

Additional information is available at the end of the chapter

<http://dx.doi.org/10.5772/64102>

Abstract

Lab-on-a-chip (LOC) and microfluidics are important technologies with numerous applications from drug delivery to tissue engineering. LOC integrates fluidic and electronic components on a single chip and becomes very attractive due to the possibility of their state-of-art implementation in personalized devices for the point-of-care treatments. Microfluidics is the technique that deals with small (10^{-9} to 10^{-18} L) amounts of fluids, using channels with dimensions of 10 to 100 μm . These LOC and microfluidics devices enable the development of next-generation portable and implantable bioelectronics devices. Superior chip-based technologies are emerging with the advances in microfluidics and motivating various chip-based methods for rapid low-cost analysis as compared to traditional laboratory method. An organ-on-chip (OOC) is on-chip cell culture device created with microfabrication techniques and contains continuously perfused chambers inhabited by living cells that simulate tissue- and organ-level physiology. *In vitro* models of cells, tissues and organ based on LOC devices are a major breakthrough for research in biologic systems and mechanisms. The recapitulations of cellular events in OOC devices provide them an edge over two-dimensional (2D) and three-dimensional (3D) cultures and open a gateway for their newer applications in biomedicine such as tissue engineering, drug discovery and disease modeling. In this chapter, the advancement and potential applications of OOC devices are discussed.

Keywords: lab-on-chip, MEMS, organ-on-chip, 3D cell culture, drug discovery

1. Introduction: why cell and organ on chip?

The field of microfluidics or lab-on-chip (LOC) technology aims to advance and broaden the possibilities of bioassays, cell biology and biomedical research based on the idea of miniaturization.

zation. Microfluidic systems allow more accurate modeling of physiological situations for both fundamental research and drug development [1].

Drug discovery and research is the prime aspect of any pharmaceutical company. The past 50–60 years have witnessed significant scientific and technological growth in entire field of biotechnology, computational drug design and screening and advances in scientific knowledge, such as an understanding of disease mechanisms, new drug targets and biomarkers discovery. In principal, these advancements should also be reflected in rise of new commercial products and drugs, but unfortunately, the pharmaceutical industry is facing unprecedented challenges owing to rising costs and the declining efficiency of drug research and development. Modern drug development requires implementation of extensive preclinical testing, and validation protocols before potential therapeutic compounds are approved to progress to clinical evaluation. This process is costly and time-consuming, as well as inefficient as for every 10 drugs entering clinical trials, only one or two will typically be licensed for eventual use in humans [2]. The number of new drugs approved per billion US dollars spent on R&D has halved roughly every 9 years since 1950, falling around 80-fold in inflation-adjusted terms.

The failures of drug clinical trial are primarily due to the poor predictive power of existing preclinical models. The existing cell culture techniques often failed to mimic the complexity of living systems and are incapable of modeling situations where organ-organ or tissue-tissue communication are important. Moreover, cells maintained in standard *in vitro* culture conditions often suffer from incomplete maturation or are held in a configuration that prevents their full functional development, making predictions of *in vivo* tissue function more difficult to extrapolate. Although animal models preserve the intricacy of living systems, due to the inherent complexity of interconnected tissues, elucidation of specific mode of drug action is often difficult that leads to confound observations. Furthermore, animal models have, on multiple occasions, been predicated human responses to drug treatment in a rather harmful way [3, 4]. The drug discovery community has identified the critical need for new testing approaches and an intermediate human *in vitro* model in the early stage of drug development to generate reliable predictions of drug efficacy and safety in humans that could mitigate the side effects observed in clinical trials and LOC systems can play a pivotal role in this by fulfilling this unmet need by microengineered cell culture models with miniaturized and automated assays that will increase resolution and precision. These models leverage cutting-edge microfabrication and microfluidics technologies to control the cellular microenvironment with high spatiotemporal precision and to present a variety of extracellular cues to cultured cells in a physiologically relevant context [5–6].

This chapter deals with the cutting-age research in the field of microfabrication technologies and multiorgan microdevices that mimic key aspects of human metabolism. We discuss about latest advancements and how this emerging field transforms the face of biomedicine.

1.1. Need of microfluidics technologies for global health: applications and limitations

Diagnostic applications for global health have seen a fast pace in recent years. LOC, micro total analysis systems (μ -TAS) or microfluidics systems are the major breakthrough in this regard

and with their state-of-art technology, these miniaturized integrated devices have great potential to change the face of healthcare sector globally. Basically, from industrial perspective to develop a high-throughput diagnosis system, it must utilize small chemical volumes to keep the cost of development at an affordable level. The current trend of miniaturized and automated assays can address these issues directly owing to their better resolution and accuracy. Microfluidics devices are new and promising players in healthcare segments. These devices, which scaled down analytical processes in conjugation with advances in microfluidics technology, are the soul motivation behind various chip-based methods of lower cost and rapid analysis than the conventional laboratory bench-scale methods. Although these microelectromechanical systems (MEMS) or miniaturized chip-based systems have seen a fast pace in other fields, such as electronics, aerospace and computer science, since their inception in early 1990s and have witnessed many innovations based on these techniques, in this chapter, our prime focus is how these technological advancements have been transformed into the face of biomedical sciences with its wide range of biological applications, such as high-throughput drug screening, single cell or molecule analysis and manipulation, drug delivery and advanced therapeutics, biosensing and point-of-care diagnostics, among others. [7]

Extracting new phenomena and elaborated information about the biologically active systems is the basis of all innovations in the field of biomedical sciences. The complex live systems and richness of biological processes are stimulating factors for new LOC approaches, and these emerging technologies are gradually changing the scenario, and now, we can seek experimental answers at the molecular level.

1.1.1. Development of microfluidics technologies for different applications in healthcare segment

In a broader sense, microfluidics can be linked to the development of integrated circuit technology and wafer fabrication facilities. They have unique ability to combine different systems possessing high-throughput capabilities, new data processing and storage strategies. These miniaturized devices provide new tools for highly parallel, multiplexed assays with better isolation, purification and handling of entities, cells or organisms for a simplified, parallel analysis. Initially, silicon and related materials were the preferred choices to fabricate miniaturized devices but now polymeric materials are also the stake holders for because of ease of manufacturing by embossing or molding [8]. They are attached to other surfaces such as silicon, and the formation of fluid channels and patterns on polymeric devices are relatively easy. Other materials, such as semiconductors and metals, are other necessary components of electrical detection schemes, and earlier reports are there where semiconductor nanowires and carbon nanotubes are being studied as sensor components [9, 10]. Integration of mechanical devices with fluid systems for biological implementation and to fabricate disposable systems has been reported earlier and summarized in many reviews [7, 11, 12]. **Figure 1** shows an on-chip disposable diagnostic card. In this segment, few latest applications of LOC devices are discussed briefly [50].

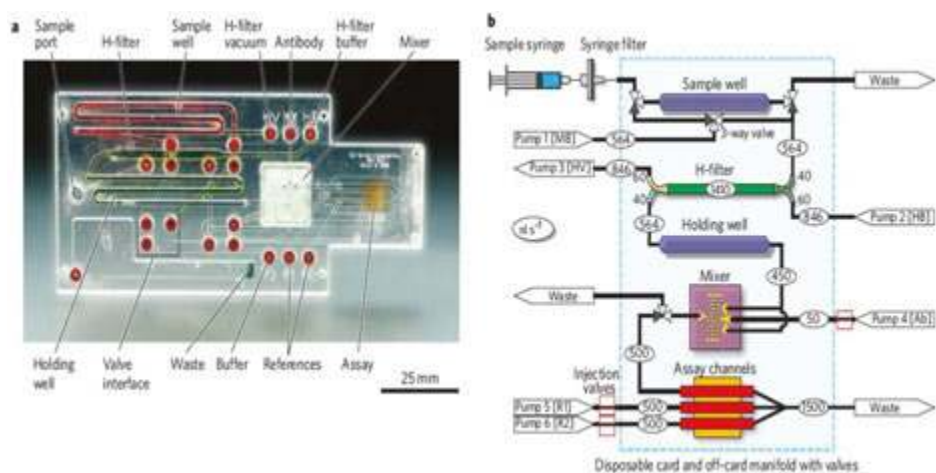

Figure 1. Example of an integrated disposable diagnostic card. (a) Image of a card. The red O-rings are for interfacing with off-card components, valves and pumps, that will eventually be incorporated onto the card itself. (b) Schematic of the card [49].

1.1.1.1. On-chip DNA hybridization and PCR

An on-chip deoxyribonucleic acid (DNA) hybridization assay refers to the bioassay conducted on the microfluidic system/device based on the nucleic acid hybridization technique [13]. From its earlier applications in 1980s, it has been evolved as a powerful tool to detect and identify the presence of a specific DNA sequence. On-chip DNA hybridization systems are amalgamation of advantages of both microfluidics and hybridization.

In the past 20 years, microfluidics devices have been emerged as an important area of research. As a combination, miniaturization eliminates the need of large reagent consumption, time-consuming labor-intensive procedures and involvement of bulky or expensive equipment while keeping its distinctive advantages of high sensitivity, selectivity and specificity of conventional techniques. Additionally, these miniaturized devices can play a pivotal role in healthcare sector of the Third World countries, by bringing cheaper and smaller, but still sophisticated analytical tools to rural areas and resource-poor regions [14]. This section focuses on few recent application of on-chip polymerase chain reaction (PCR) devices. There are few criteria to be taken care of while designing on-chip PCR systems such as high-temperature resolution and acquisition rate for precise thermal cycling in microfluidics. Apart from traditionally embedded thermocouples and thermometers [15–17], Wu et al. [18] reported an integrated PCR system with a temperature controller using platinum (Pt) thin film as heater and temperature sensor, an optical detection system and an interchangeable (disposable or modular) PCR chip, which was independent from the two functional systems as shown in **Figure 2**. In this system, Pt thin-film sensor was patterned to microsize and integrated to thin-film heater into the chip to provide rapid response and precise integration.

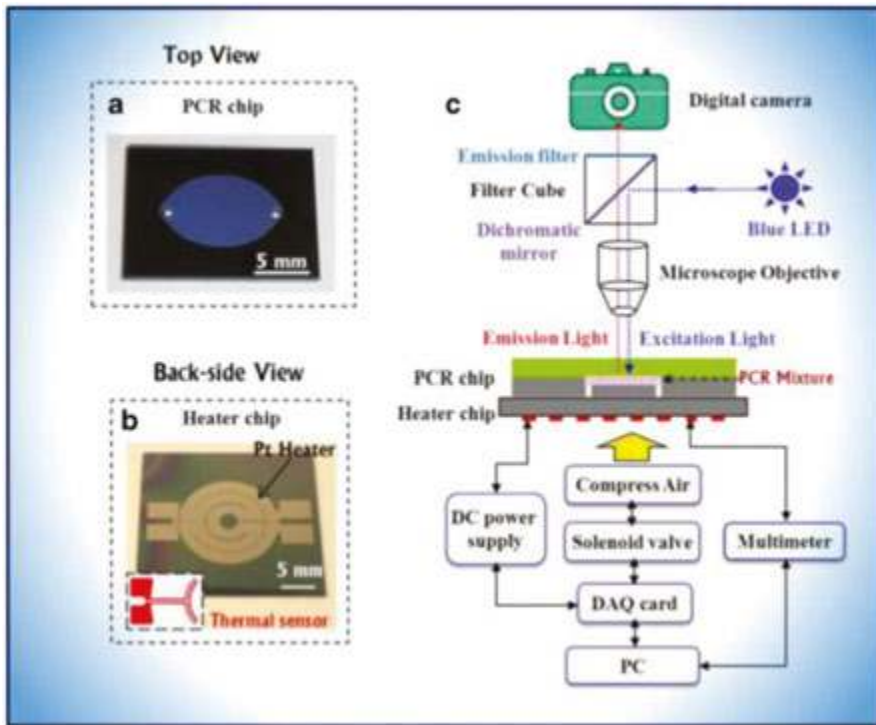

Figure 2. Interchangeable PCR chip and temperature control device. (a) Top view of PCR chip. (b) Back side view of heater chip, Pt heater and thermal sensor were integrated in one chip. (c) optical detection system in upper panel [18].

In another approach, Chia et al. developed fully integrated, portable PCR device that consists of the following four major parts: a disposable chamber chip with microchannels and pumping membranes, a heater chip with microheaters and temperature sensors, a linear array of electromagnetic actuators and a control/sensing circuit. Apart from the small size ($67 \times 67 \times 25 \text{ mm}^3$) and less power consumption (5V DC) and reduced volume of DNA solution, this system could effectively reduce the PCR process time into one-third of the time required by typical commercial PCR system [19]. In another approach, Steinbach et al. [20] came forward with their K-Ras mutation detection on chip. **Figure 3** shows schematic of the on-chip detection device. They aimed to develop a fast and reliable chip-based K-Ras mutation based on existing microfluidic chip platform for visual signal readout of K-Ras mutation profiling. Successful hybrid formation was monitored by streptavidin horseradish peroxidase binding, followed by an enzymatic silver deposition. Silver spots represented robust endpoint signals that enabled visual detection and grey value analysis. This study has the potential to replace expensive detection devices. These few examples give a gist of microfluidics in DNA detection and PCR. Many reviews are available on this topic [13, 21, 22].

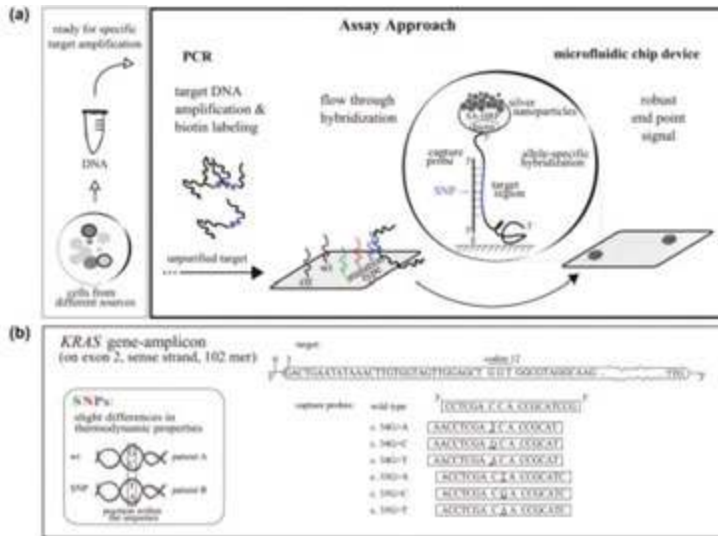

Figure 3. Assay design (a) The schematic workflow of the assay is pictured, starting from isolation of genomic DNA from cells, DNA amplification and on-chip hybridization, respectively. (b) The location of KRAS codon 12 mutations within the amplicon and the corresponding capture probes is illustrated (ctr = positive control; wt = wild type; SNP = single-nucleotide polymorphism; SA-HRP = streptavidin horseradish peroxidase) [20].

1.1.1.2. On-chip biosensing and disposable point-of-care devices

Over the past decade, on-chip diagnostic systems observed explosive growth and showed significant potential for clinical diagnostics specifically for diseases, including toxicity. The early, rapid and sensitive detection of the disease state is the prime objective for every on-chip clinical diagnosis. Initially, this field was focused on developing the concepts of LOC and later evolved to applications in a number of biochemical analysis operations, such as clinical analysis (blood gas analysis, glucose/lactate analysis, etc.) [23].

In on-chip diagnosis devices, apart from pregnancy detection kit and glucometer, most applications are based on genes and peptides detection for early indicators of disease [24–26]. For instance, Dinh et al describe a multifunctional biochip with nucleic acid and antibody probe receptors specific to the gene fragments of *Bacillus anthracis* and *Escherichia coli*, respectively [25]. These devices were based on the detection of specific diseases or biological warfare agents by incorporating biomarkers specific to such agents. Monitoring of regular metabolic parameters, such as glucose and lactate, was demonstrated by the I-Stat analyzer that provides point-of-care testing for monitoring a variety of clinically relevant parameters [26]. Immunosensing applications as a part of clinical diagnostics have also been demonstrated [27, 28].

Recent years have witnessed a vast range of applications of LOC due to the significant benefits of small sample and reagent volume utilization, economic and rapid analysis with less wastage and possibility of developing disposable devices. Ahn et al. demonstrated a fully integrated

module of wristwatch-sized analyzer that included a smart passive microfluidic manipulation system based on the structurally programmable microfluidic system (sPROMs) technology, for preprogrammed sets of microfluidic sequencing with an on-chip pressure source for fluid driving, sequencing and biochemical sensors [23]. Point-of-care testing (POCT) is one of the most impressive developments of microfluidics in life sciences and can be defined as diagnostic testing at or near the site of patient care to make the test convenient and immediate. In many countries, DNA test kits for HIV are already available [29]. This is a rapidly growing field, and more detailed information can be obtained from various reviews in this area [23, 31, 32].

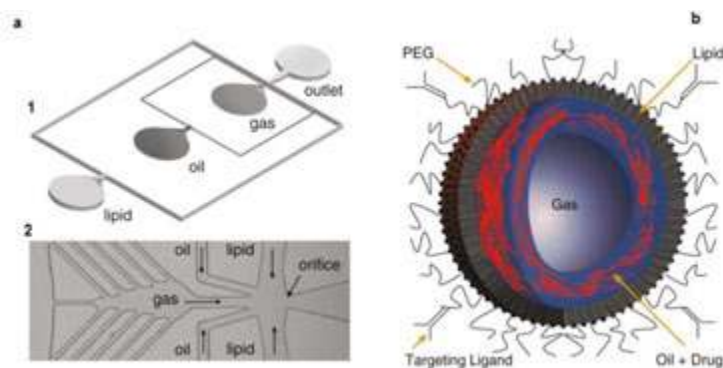

Figure 4. (a) View of microfluidic chip featuring the two distinct hydrodynamic flow-focusing regions and expanding nozzle geometry with a narrow orifice. All channels have a rectangular cross section and a height of 25 μm . (b) View of targeted lipospheres with gas in core and active ingredient in lipid oil complex [36].

1.1.1.3. Drug delivery applications

The major objective of drug delivery systems is to localize the pharmacological activity of the drug at the site of action as targeted drug delivery systems directly deliver the payload to the desired site of action with minimum interaction with normal cells. This phenomenon is especially important for anticancer drugs, as their toxicity to healthy cells is a cause of concern to improve therapeutic response and patient compliance. Last decade witnessed tremendous growth in targeted dosage forms for controlled release [33–35].

Approximately 10 million people suffer from different kinds of cancer per year and many of them unfortunately die due to lack of better treatment strategies. With the advancement in diagnostic, therapy techniques and nanomedicine, now better understanding of disease onset and treatment is possible, but still more will be offered by state-of-art microfluidic technology in terms of control over particle size, composition, encapsulation rate and better performance of nanoformulations, which have a great impact on the cancer survival rate.

In the series of microfluidics-based delivery systems, a gas-filled lipospheres was reported by Hettiarachchi et al. for targeted delivery of doxorubicin, using polydimethylsiloxane (PDMS)-based microfluidic chip that contained two distinct hydrodynamic flow-focusing regions for

local administration into tumor tissues as shown in **Figure 4a** [36]. Generally, liposomal-encapsulated doxorubicin suffers from relatively nonspecific biodistribution due to size selection and nontargeted accumulation [37]. As a solution, Hettiarachchi et al. prepared multilayer lipospheres with oil layer of triacetin (capable of carrying bioactive molecule) sandwiched between inner gas-filled core and outer lipid layer (polyethylene glycol (PEG) lipid conjugate DSPE-PEG2000-Biotin) with avidin as targeting moieties based on the fact that multilayer gas-filled lipospheres for high payload delivery at target sites could overcome the limitations of liposomal preparation. **Figure 4b** is representation of the modified delivery system.

Another strategy that is gaining importance in diagnosis and treatment of cancer is theranostic nanomedicine that combines imaging, diagnostic agent and antitumor agent. Theranostic lipid complex nanoparticles formed by bulk mixing do not give control over composition and size which can be overcome with a microfluidic setup [37, 38]. A static micromixer-coaxial electrospay (MCE) for the single-step synthesis of theranostic-lipid complex nanoparticles (cationic lipid-nucleic acid complexes called lipoplexes) was designed by Wu et al. to overcome this limitation. Multicriteria evaluation (MCE) technique produced monodispersed particles with a diameter of ~ 194 nm and high encapsulation efficiency compared to a more conventional bulk process; the advantage of this process is shown in **Figure 5a**. Quantum dots (QD605) and Cy5-labeled antisense oligodeoxynucleotides (Cy5-G3139) were encapsulated as the model imaging reagent and therapeutic drug, respectively, with successful cytoplasm to delivery of drug into cytoplasm of A549 cells (nonsmall-cell lung cancer cell line) leading to $48 \pm 6\%$ down regulation of the Bcl-2 gene expression [37].

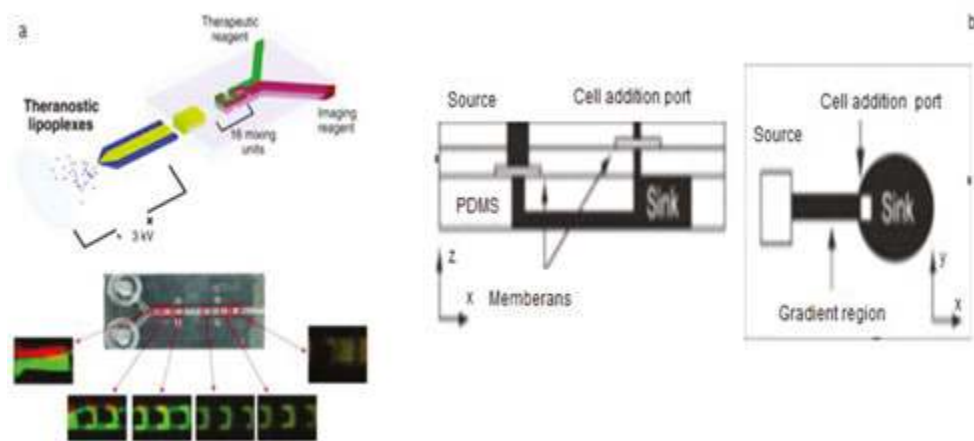

Figure 5. (a) Schematic drawing of the static micromixer-coaxial electrospay (MCE) showing its various components [37]. (b) Schematic of microfluidic gradient generator [40].

A *microfluidic gradient generator* (MGG) was developed by Abhyankar et al. [39, 40] for testing drug response on a cellular basis. These devices offered unique features of, higher resolution, real-time observation, tunable drug concentration and reduced costs in comparison with their conventional counterparts, Transwell and Dunn chambers. MGGs are based on two techniques – gradient achievement through time-evolving diffusion or parallel streams mixing. **Figure 5b** shows a sink-source flow-free gradient generator. The absence of convection flow is the key advantage of this system that eliminates the shear-stress induced to cells.

Apart from nano-based drug delivery techniques, administration of drug to the whole body is another application of microfluidics where miniaturized needles can be designed (*microneedles*) for improved delivery effectiveness and reduce the pain related to drug administering.

Microneedles can be classified into the following four general types: (i) solid microneedles, (ii) drug coated, (iii) polymeric microneedles with encapsulate drug that fully dissolve in the skin and (iv) hollow microneedles for drug infusion into skin.

1.1.1.4. *Microarrays technologies*

A microarray is an analytical device that comprises an array of molecules (oligonucleotides, cDNAs, clones, PCR products, polypeptides, antibodies and others) or tissue sections immobilized at discrete ordered [41]. In a general microarray device, sample solutions are confined in microfabricated channels and flow through the probe microarray area. Enhanced sensitivity is obtained due to high surface-to-volume ratio in microchannels of nanoliter volume and advantages of both fields can be exploited simultaneously by combining DNA microarray with microfluidics [42, 43]. Consumption of small volumes in microfluidic systems is an added advantage to develop low-cost, compact and portable LOC systems. Secondly, the surface hybridization of target DNA can also be accelerated on microfluidics platform by electrokinetic delivery of negative charged DNA molecules on to the probe area [44].

Lee et al. proposed a recirculating microfluidic device for the hybridization of oligonucleotides to DNA microarray [45]. Peristaltic pump was connected to the both ends of the microchamber to generate circulatory flow as shown in **Figure 6a**. With this device, hybridization time was also shortened to 2 h and sample volume was 100 μ L.

Many companies are involved in designing microfluidic technology for various high-throughput applications, such as immunoassays, diagnostic devices, single molecule DNA and protein detection as well [42]. Researchers from the University of Chicago, USA, and other laboratories demonstrated the use of two-phase droplet systems that generate droplets within microfluidic channels to be used as microreactors for high-throughput screening of compounds and multiple chemical reactions [46, 47]. Recently, Huang et al. presented a microfluidic device integrated with pneumatically controlled microvalves and micropumps for parallel DNA hybridizations to analyze 48 different DNA targets (18-mer oligonucleotides derived from the Dengue viral genes) simultaneously. A schematic of device is shown in **Figure 6b** [48].

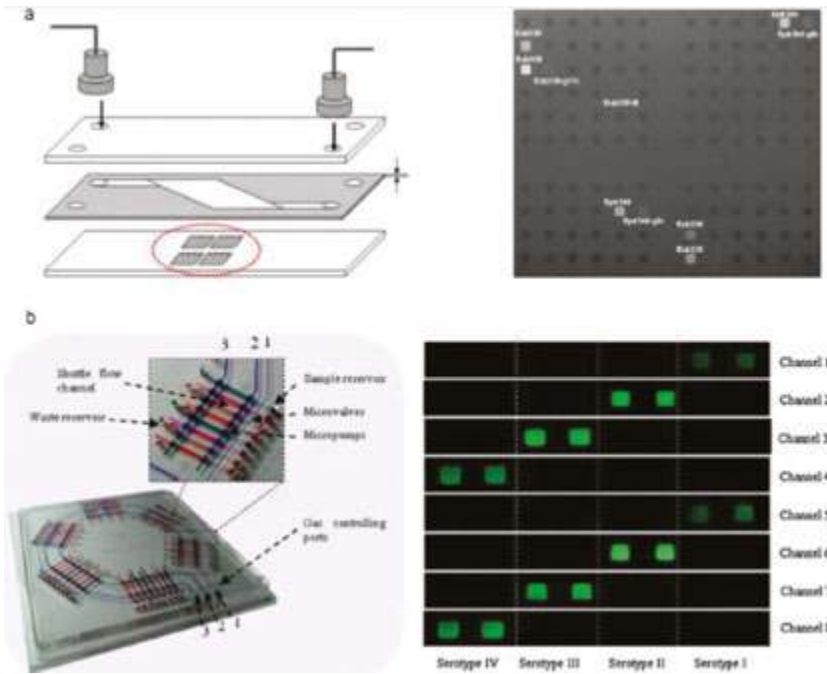

Figure 6. (a) Diagram for sample recirculation system on the hybridization chamber and hybridization image of fluorescence-labeled target nucleotide [45]. (b) *Left:* Photograph of the microfluidic chip containing shuttle-flow channels, microvalves and micropumps. The shuttle flow hybridization was realized by controlling the gas ports 1, 2 and 3 automatically. *Right:* Hybridization specificity assay using four serotypes of Dengue virus under shuttle flow conditions (frequency 2 Hz) in channels. The duration of hybridization process was 90 s and washing time was 30 s [48].

The commercialization of microarray and microfluidic technologies is evolving very fast as demonstrated by the emergence of many start-up companies due to its state-of-art technology. Affymetrix is an example where they generated a new market based on their GeneChip® technology over a 12-year period.

1.1.2. Challenges for lab-on-chip devices

Apparently, microfluidics devices have the potential to serve different scientific needs of healthcare and biomedical sectors and as we discussed earlier, their several successful applications have already been reported. The major advantages associated with miniaturized systems are faster/more accurate diagnoses; better epidemiological data for disease modeling; vaccine introduction; and utilization of minimally trained healthcare workers and better use of existing therapeutics but still many hurdles are there in broader applications of microfluidics systems.

However, there is always a silver lining and due to vastly increased interest in global health issues, the current funding climate for the development of diagnostics kits is significantly good.

Financial support for new and improved diagnostic tools for priority diseases, such as tuberculosis and cancer, is there. The Gates Foundation's Grand Challenges in Global Health initiative is supporting the development of prototypes of a disposable/hand-held reader system [49]. Thanks to increased attention on the global health issues and the motivation for their better treatment, we are witnessing the beginning of microfluidics diagnostic devices for early detection of these fatal diseases in coming few years.

We started our discussion on the issues of need of miniaturized devices for pharma industry and biomedicine. After a brief overview on impact of existing LOC systems on global health, we discuss how the new emerging cells and OOC techniques will have an everlasting effect on different areas of human health. The latest progress in microfluidics has led to the development of OOC microdevices, which recapitulate the complex structure, microenvironment and physiological functionality of living human organs. The practical implementation of these miniature organ systems is revolutionary for the field of biomedical sciences and will play a pivotal role for drug discovery and will improve our understanding for mode of action of molecules of therapeutic potential—overall, this state-of-art technology is expected to be a boon for pharma and healthcare sector.

2. Evolution of cells and organ on chip: from 3D culture to organ on chip

The process of growing eukaryotic cells *in vitro* was put forth by Harrison in 1907 to investigate the origin of nerve fibers [50] and since then its almost 100 years, these 2D cell cultures have greatly advanced our knowledge of cellular biology. They have been routinely and diligently undertaken in thousands of laboratories worldwide. However, the 2D cell cultures are arguably primitive and do not reflect the anatomy or physiology of a cell or tissue microenvironment in true sense. Two-dimensional (2D) cell cultures oversimplify the extracellular matrix (ECM) and cell microenvironment and the processes, such as drug delivery, toxicological analysis, gene expression and apoptosis, may not be directly taken up for the *in vivo* experiments from 2D analysis as ECM is completely different in *in vitro* and *in vivo* and cannot be adequately mimicked by 2D cell systems [51, 52]. These limitations of 2D cell culture led to the innovation of 3D cell culture methodologies; the concept that gave birth to the idea of OOC devices. In 3D culture, cells are grown in extracellular matrix, that is, hydrogels, scaffolds or on hanging drops. The cells, growing in third dimension, exhibit enhanced expression of differentiated functions and improved tissue organization but require a multidisciplinary approach and expertise [53, 54].

Generally, spheroids, cell aggregates and cell sheets are the common platforms for 3D culturing [55–60]. Basic objectives for developing 3D cell culture systems vary from engineering tissues for clinical delivery to the development of models for drug screening. It was observed that certain cellular processes of differentiation and morphogenesis for tissue engineering occurred preferentially in 3D instead of 2D.

In one study by Slamon et al., alteration of cellular architecture between 2D and 3D cells was observed in the growth of SKBR-3 cells that overexpress HER2, an oncogene found to be

overexpressed in approximately 25% of breast tumors [61]. Cells grown as 3D spheroids using p-HEMA-coated plates had HER2 homodimers form, while in 2D cultures, HER2 formed heterodimers with HER3 [61]. Recently, Choi et al. [62] also reported that human neural stem cells with familial Alzheimer's disease mutations when grown in 3D culture recapitulate both amyloid- β plaques and neurofibrillary tangles. 3D cell culture more accurately simulates normal cell morphology, proliferation, differentiation and migrations. Similarly, in chemotherapy procedures, a difference in sensitivity to drug exposure was observed in cells grown in 2D or 3D microenvironments [63]. A study by Tung et al. indicated that A431.H9 cells grown in 2D and 3D show differences in viability when treated with the same concentrations of 5-fluorouracil (5-FU) and tirapazamine (TPZ). In the case of 5-FU, 2D cultures were reduced to approximately 5% viability following a 96-h treatment (5-FU; 10 mM), whereas 3D cells treated with the same concentration and duration, showed 75% viability; indicating that these 3D spheroids were more resistant to the antiproliferative effects of 5-FU [64].

In recent years, an increasing shift in research focus from 2D cells cultures to 3D cell cultures occurred which in turn translated 2D *in vitro* research to 3D *in vivo* animal models.

2.1. Advantages and limitations of 3D cell culture

- Flexible synthesis approach in 3D cell culture allows facile manipulations for cellular microenvironment modeling.
- With 3D cell culture systems, study at different states of disease models can be done in a similar tissue microenvironment that may reduce the need of animal testing.
- 3D culturing is more authentic way of monitoring drug metabolism studies instead of 2D. Due to the presence of layers of cells in 3D culture with tightly bind cells as compare to a monolayer in 2D, drug diffusion to cells by blocking or slowing simulate the real barriers for drug action.
- Scaffolds to support 3D cell with simultaneous growth factor, drug or gene delivery can also be synthesized.
- 3D cell culture has direct applications in tissue engineering and regenerative medicine.

Figure 7 is schematic of various methods of synthesis of 3D culture, including hanging drop, forced floating method, etc.

It is an evolving field and requires further research for its optimization, and therefore, it is evident that some clarity is needed in selecting the best method for the generation of 3D cells from individual cell lines. Additionally, the best established 3D culture methods currently available produce avascular tumor models that failed to mimic the full architecture of *in vivo* tissues and vascularization aspect of tumor development is left out, which is a huge significant part of true tumorigenesis. These limitations are the prime hurdles in the application of 3D culture as potential drug discovery tools.

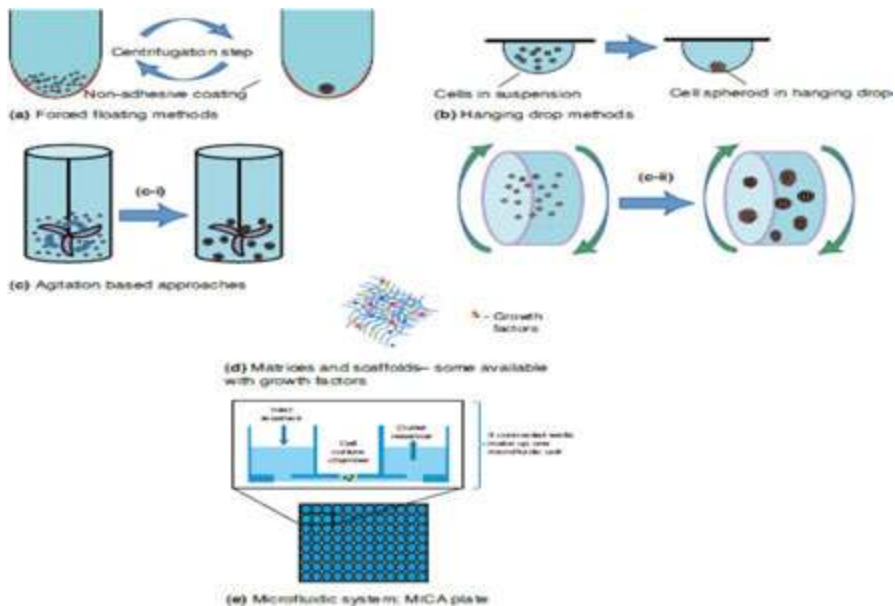

Figure 7. Schematic of 3D culture synthesis methods. These methods include forced-floating of cells; hanging drop methods; agitation-based approaches; the use of matrices or scaffolds; and microfluidic systems [53].

2.2. From 3D culture to organs on chips: a giant leap toward biomedicine revolution

In previous section, we discussed the role of 3D cell culture and its significant impact on different fields. The next important step of 3D microfabrication is evolution of integrated OOC microsystems with the ability to mimic key structural, functional, biochemical and mechanical features as well as interactional effect of microenvironment on cell and tissues *in vivo* of living organs in a single device [65]. By definition, OOC devices are microfluidic devices for culturing living cells in continuously perfused, micrometersized chambers in order to model physiological functions of tissues and organs [66].

Cellular behavior and its interaction with *in vivo* microenvironment is still an unsolved mystery. Advancements in the field of 3D OOC opened entirely new possibilities to create *in vitro* models that reconstitute more complex, 3D, organ-level structures, with integrated chemical signals and important dynamic mechanical cues. OOC devices not only mimic the cells biomechanical and biochemical behavior in *in vivo* tissue but also predict the interactional effects of microenvironment on cells and tissue functions [58]. This unique ability of OOC devices makes them a potential candidate for drug discovery programs and a boon for healthcare segment. Though this state-of-art innovation is in its nascent state, preliminary data obtained had shown promising future of OOC devices with wide applications in biomedical sciences. As a proof of concept, researchers have fabricated two stacked PDMS cell culture

chambers separated by permeable synthetic membrane to study polarized functions of various epithelial cells of intestine [67, 68], lung [69], kidney [70], heart [71], etc.

2.3. Basic microfabrication techniques and material for OOC devices

To mimic *in vivo* organ-specific microenvironment, OOC devices required high precision and accuracy. Microfabrication techniques are the preferred methodologies to fabricate OOC devices due to feasibility of constructing tissue-specific environment at microscale. Typical techniques include replica modeling, soft lithography and microcontact printing [52, 66, 72]. **Figure 8** is a schematic representation of these techniques.

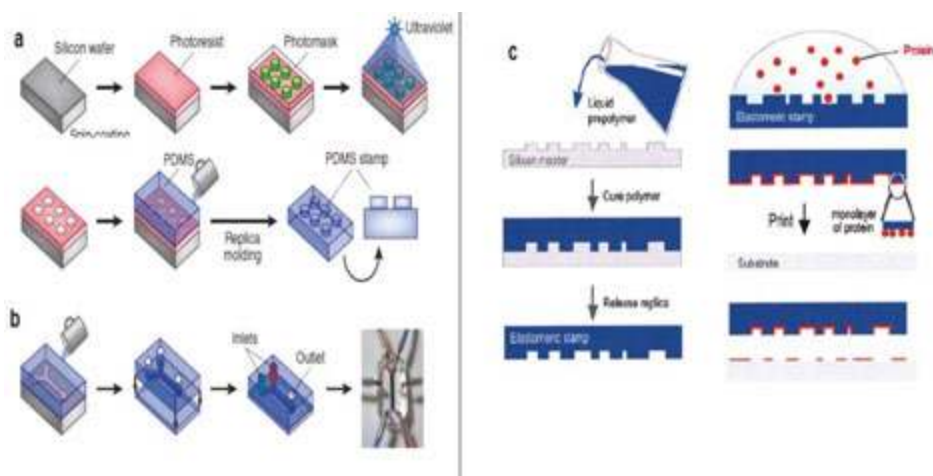

Figure 8. Schematic of microfabrication techniques. (a) Replica modeling. (b) PDMS stamp for formation of microchannels [158]. (c) Microcontact printed protein for cell patterning [159].

Replica molding techniques have been used to replicate complex surface relief patterns to produce biomimetic structures that mimic organ-specific microarchitecture. Lee et al. designed the replica modeling techniques to recreate the artificial liver sinusoid and natural endothelial barrier layer in liver. [73] This was an important breakthrough that successfully reconstituted a tissue-tissue interface that was a critical element of whole liver organ structure, and was not possible in conventional 3D ECM gel cultures. In other report by Esch et al [74], photolithography was explored to recreate the key aspects of villi structure on microfluidic chambers covered by 3D shaped, porous membranes for models of the gastrointestinal tract epithelium by two-exposure step fabrication process. As shown in **Figure 9**, complete crosslinking was used to fabricate the chamber and partial with SU-8 to form the porous membrane. This microdevice could create better *in vitro* models of human barrier tissues, such as the gastrointestinal tract epithelium, the lung epithelium or other barrier tissues with multiorgan “body-on-a-chip” devices for drug-screening application.

An array of PDMS microchambers interconnected by 1 μm wide channels was similarly used to enable growth and *in vivo*-like reorganization of osteocytes in a 3D environment that replicated the lacuna-canalicular network of bone [76]. In a similar approach, Sudo et al. came up with the idea of a microdevice incorporating ECM gels microinjected between two parallel microchannels to investigate vascularization of liver tissues in 3D culture microenvironments [76], while a compartmentalized microfluidic system for coculturing of neurons and oligodendrocytes to study neuron-glia communication during development of the central nervous system was developed by Park et al. [77]

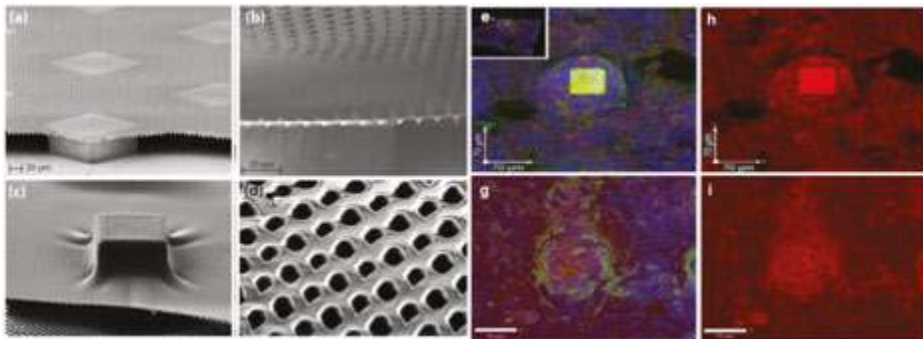

Figure 9. Porous SU-8 membranes that are anchored to and span across microfluidic chambers. The membranes are either flat (a and b), or they were dried over sacrificial silicon pillars and take on the shape of the pillars (c and d). (b) A higher magnification scanning electron microscopy image of a flat membrane with 3 μm pores. (d) Close-up of the 3D-shaped membrane imaged in (c). The image reveals the membrane's porous character. The sacrificial silicon pillars can be removed via xenon difluoride etching 3D cell culture of gastrointestinal epithelial cells (Caco-2) that were grown for 8 days (a, b, c) and 21 days (d, e, f) on porous SU-8 membranes that were dried on silicon pillars (50 μm wide and 200 μm high) [74].

From their inception, production of these microdevices relied on silicon microfabrication and micromachining techniques. Although widely explored and applied, silicon micromachining is rather complex, costly with limited accessibility to specialized engineers. To overcome these practical hurdles, researchers developed microfluidic systems made of the silicone rubber, poly(dimethylsiloxane) (PDMS), that are less expensive and easier to fabricate, which opened entirely new avenues of exploration in cell biology. [6]

PDMS has several unique properties that make it a perfect choice for the fabrication of microdevices for the culture of cells and tissues. First, PDMS possesses superior gas permeability and flexibility for adequate oxygen supply to cells in microchannels, which eliminates the need for separate oxygenators, commonly required in silicon, glass and plastic device and is particularly important to maintain differentiated function of primary cells of high metabolic demand [54, 78]. PDMS microfluidic systems enabled the formation of viable and functional human tissues.

Excellent optical transparency is prime advantage of PDMS that enabled real-time monitoring of nitric oxide production and variation in pulmonary vascular resistance in a microfluidic model and cell morphology, tissue repair and reorganization. [79–81]

Moreover, control of cellular parameters is another important phenomenon in designing OOC devices and recent advances in microfabrication techniques have significant contribution toward efficient monitoring and control of cellular responses and study of broad array of physiological factors that wasn't possible with 3D static cultures. Electrical, chemical, mechanical and optical probes for direct visualization and quantitative analysis of cellular biochemistry, gene expression, structure and mechanical responses also can be integrated into virtually any microfabricated cell culture devices and more relevant data can be obtained with these advanced OOC devices. [54, 66]

3. Organ-on-chip devices: concept to application

In this section, various state-of-art existing OOC platforms and their structural features, working principles, potential and feasibility for biomedical application are discussed. OOC devices can be defined as microfluidics systems for living cells culturing in continuously perfused, micrometersized chambers in order to model physiological functions of tissues and organs [66]. The prime objective of this emerging technique is to fabricate minimal functional units of an organ that recapitulate tissue- and organ-level interactions. These devices have great potential for investigating basic mechanisms of organ physiology and are well suited for the study of biological phenomena that depends on tissue microarchitecture and perfusion and last for relatively short span (< I month). These chips often consist of featuring multiple, controllable parallel channels, splitting and merging channels, various pumps, valves and integrated electrical and biochemical sensors. Some kind of microenvironment stimuli derived from organ-level functions can be applied to cells from certain organ.

3.1. Basic working mechanism of OOC devices

OOC systems are basically elaborated microengineered physiological systems that reconstitute the key features of specific human tissues and organs and their interactions as depicted in **Figure 10** [82, 83].

Key factors in OOC designing include the following:

- Fabrication of OOC devices start with identifying the key aspects of biochemical, mechanical environment of specific organ, including local factors from neighboring cells or tissues and stretch of organ. [82].
- The final step is to measure the functional output parameters of the cultured cells.

Earlier, with 2D and 3D cell cultures, efforts were taken to control and regulate the cell growth, shape and other cellular events but due to lack of precise 3D environment, these models suffered with inaccuracy and reliability in recapitulating the issue- and organ-specific systems

[83]. But with the state-of-art OOC technology, new possibilities to create efficient *in vitro* models with organ-specific microenvironments, tissue microarchitecture reconstruction, spatio-temporalchemical gradients, tissue-specific interfaces, crucial dynamic mechanical cues and biochemical signals [54, 84]. In this section, we describe recent progress in this field and currently reported OOC devices such as liver, kidney, intestine, kidney, heart, skin and blood vessels.

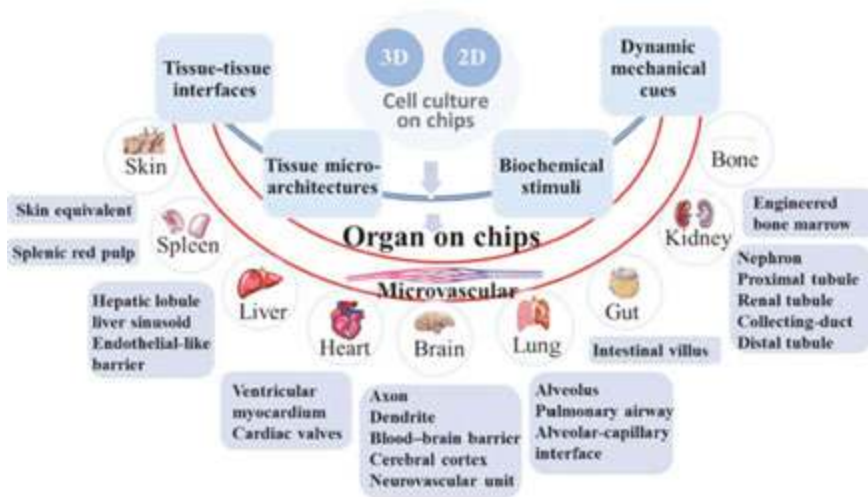

Figure 10. Representation of organ-on-chip device and concept of modeling, a complex microenvironment and their existing simulation of functional units [82].

OOC devices can be classified into three broad segments based on the working mechanisms: [82]

- i. Membrane-based penetration and mechanical stimuli—blood-brain barrier, lung, kidney, gut, heart on chip.
- ii. Organ function mimicking based on anatomy—arteries and spleen on chip.
- iii. Perfusion-based OOC devices—liver, brain and womb on chip.

3.2. Membrane-based organ on-chip devices

To study the drug response with respect to human biological barriers is a crucial step in drug discovery. Researchers developed 3D compartmentalization with membrane-based multilayer compartments for mimicking biological barriers such as the blood-brain barrier [85, 86, 99], the kidney transport barrier [87, 71], and the lung's alveolar-capillary interface [88, 89] that can be considered a major breakthrough for biomedicine. In this segment, recent discoveries in membrane and muscular thin films to recapitulate the physiochemical interface and mechanical cues are described.

3.2.1. Lung on a chip

Lung is an important organ of respiratory system for the exchange of oxygen and carbon dioxide in blood stream. The elementary tissue unit of the lung is the layer of epithelial and endothelial cells over which the exchange of gases between air and blood takes place. The geometry of the lung tissue contains the epithelial-endothelial interface, epithelium-air interface, endothelium-blood interface and periodic mechanical force with each respiratory cycle. Understanding of cell-cell interactions, cell-blood and cell-gas flow is utmost necessary for drug discoveries and physiochemical research. Complex geometric and compositional structure of lung is the great barrier to enable straightforward manipulation and observation of cells.

Lung-on-chip is the microreplica of the lung on a microchip. This is used for nanotoxicology studies of various nanoparticles that are introduced into the air channels and to understand the pulmonary diseases where due to the formation of liquid plug that blocks small airways and obstruct gas flow in alveoli [89]. To understand the mechanism of liquid plug propagation and rupture, Huh et al. designed a microengineered system that consists of two PDMS chambers separated by thin polyester membrane with 400-nm pores. This system mimicked an *in vivo* basement membrane for small airway epithelial cells (SAECs) attachment and growth.

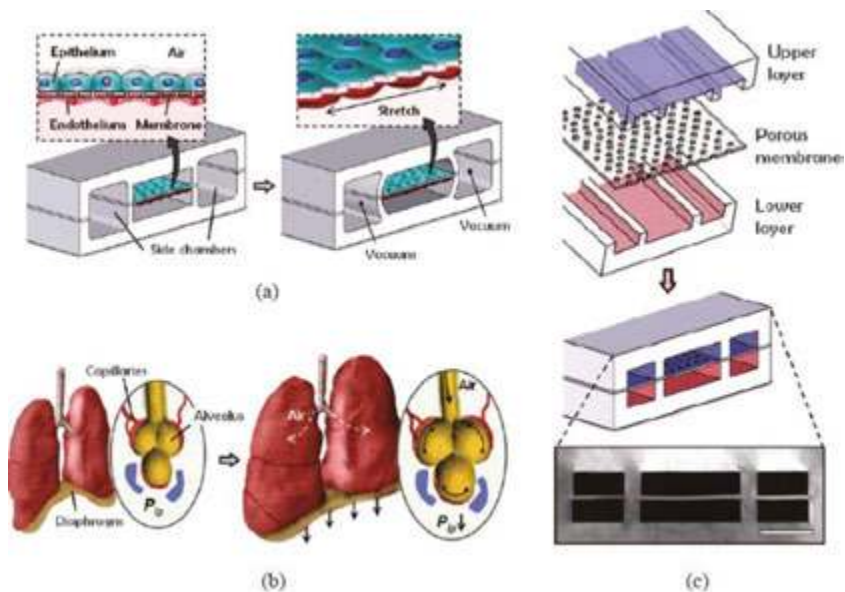

Figure 11. Schematic of lung on-chip system. (a) PDMS-based membrane to mimic alveolar capillary barrier and a vacuum based deformation controller. (b) Size variation of lung during inhalation. (c) Bonding and alignment of three layer PDMS devices [70].

Using this system, injurious response of SAECs to propagation and rupture of finite liquid plugs at an air-liquid interface afflicted with surfactant deficiency was demonstrated [88]. Another report by Huh et al. designed an alveoli-on-chip having alveolar and the capillary interface. To mimic the breathing pattern, two chambers were constructed at the side through which air is pumped in at certain required pressure, continuous increase and decrease of the flow is done in order to accomplish the inhalation and exhalation pattern. A thin flexible layer of PDMS was used in the central chamber where coculturing of human alveolar epithelial cells and blood vessel wall cells on the opposite sides is done. The membrane stretches and relaxes according to the flow of air. The culture medium is pumped through the lower microchannel to mimic the blood flow and the sample is injected on the top layer that interacts with the alveolar epithelial cells as shown in **Figure 11** [70]. In another model to study alveolar cell complexities, Douville et al. put forth their system consisting of two compartments—alveolar chamber and actuation channel. These chambers were separated by a PDMS thin membrane to create both cyclic stretch and fluid mechanical stresses. This *in vitro* model successfully demonstrated the difference in morphological changes cells undergo when exposed to combine stresses as compared to cells exposed solely to cyclic stretch [90].

These inventions reconstituted the critical lung functions and can be applied for *in vivo* models in environmental toxins, absorption of aerosolized therapeutics and the safety and efficacy of new drugs. Such a tool may help accelerate pharmaceutical development by reducing the reliance on current models, in which testing a single substance can cost more than \$2 million [54, 66].

3.2.2. Kidney on chip

The word kidney-on-chip suggests that the kidney is mimicked on a chip. Here, the renal cells or the nephrons are mimicked on the chip and this is used for checking the toxicity of drug and its screening. This model helped to know more about the filtration, reabsorption of the necessary molecules from the drug as kidney toxicity is a cause of concern during drug development [91]. Nephron is the basic unit of kidney and mainly consists of glomerulus, which acts as a filtering unit that helps in filtering unwanted toxic particle from the required molecules and helps in throwing out these unwanted molecules. Nephron's glomerulus, proximal convoluted tubule and loop of Henle are mimicked on the chip. As reported by Weinberg et al., an artificial nephron function with three components on a single chip was designed [92]. Jang et al. developed an on-chip kidney to reproduce cisplatin nephrotoxicity. Their device contained two compartments, where top channel mimicked urinary lumen and has fluid flow, whereas the bottom chamber imitates interstitial space filled with media. Kidney cells have less shear stress than endothelial or lung cells. This device was operated with 1 dyn/cm² of shear stress [93]. A modified version of same device using human proximal tubular cells was also developed by the same group. The advantage of using proximal cells was there less shear stress ~ 0.2 dyn/cm² that is similar to that of the living kidney tubules surrounding as shown in **Figure 12** [94]. Better understating of filtration pattern and absorption behavior that leads to toxicity was the prime aspect of this discovery.

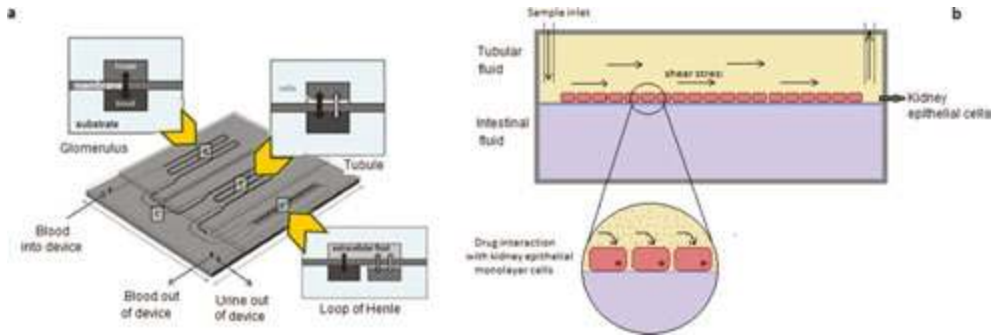

Figure 12. (a) Nephron on a chip: Schematic of the chip with cross sections of three functional units named glomerulus, proximal convoluted tubule and loop of Henle, which are response for filtration, reabsorption and urea concentration, respectively. (b) Kidney reabsorption functions using a microfluidic chip comprising of an apical channel separated from a bottom channel by proximal tubular epithelial cells cultured ECM-coated porous membrane [94].

3.2.3. Blood-brain barrier on chip

To understand and treat neurological diseases, proper understanding of blood-brain barrier (BBB) is utmost important. By definition, BBB is a unique selective barrier membrane that obstructs the passage of most exogenous compounds in blood to the central nervous system (CNS) while permeable for essential amino acids and nutrients. It is made primarily of three different cells: endothelial, pericytes and astrocytes, and the membrane is formed by firm junctions between endothelial cells that control compound permeability with high values of transendothelial electrical resistance (TEER) [82, 95]. Hatherell et al. designed a membrane-based system to replicate BBB by cultivating endothelial cells on the top side of a transwell membrane while cultivating astrocytes with or without pericytes on the opposite side [88]. However, due to low porosity and uneven pore distribution, this artificial membrane failed to recreate the close proximity to cell interaction. To address this issue, silicon nitride membrane was developed by Ma et al. to increase the direct contact between the cells and astrocytes [96]. Another report by Shayan et al. also demonstrated a considerable reduction of the flow resistance across a nanofabricated membrane with controlled pore size and low thickness (3 μm) and maintenance of metabolic activity and viability for at least 3 days [97]. A novel BBB *in vitro* model was developed by Brown et al. for efficient cell-to-cell communication between endothelial cells, pericytes, and astrocytes and independent perfusion with vascular chamber and brain chamber separated by a porous membrane (**Figure 13a**) [98]. Booth and Kim also developed a BBB that impersonated the dynamic cerebrovascular environment having fluid shear stress and a comparatively thin culture membrane of 10 μm (**Figure 13b**). This system has two components called luminal and abluminal on which endothelial and astrocytes were cultured to form the neurovascular unit [99].

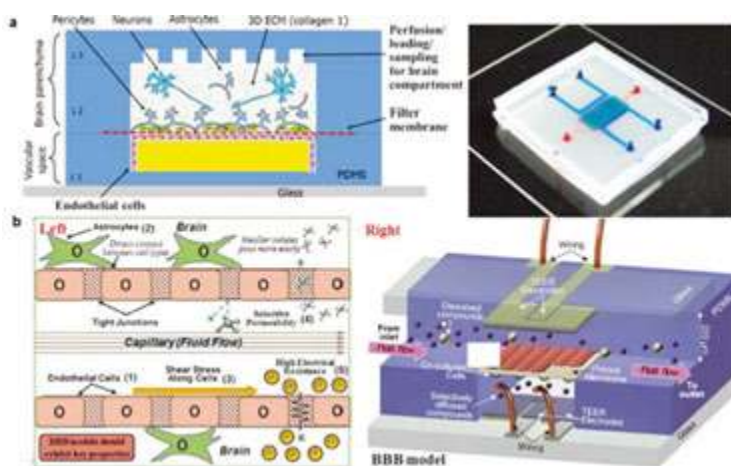

Figure 13. Schematic view of the neurovascular unit (NVU) indicating major components, cell types and their spatial arrangement. (a) Illustration of key properties should be included in an effective *in vitro* microfluidic blood-brain barrier (μ BBB) models (left). (b) Structure of microdevice consisting of two channels for astrocytes and endothelial cells culture with electrodes for transendothelial electrical resistance (TEER) measurement [98, 99].

These novel systems are the promising tools of future due to their unique characteristics of feasible real time, TEER and selective permeability to study barrier function and delivery of drugs to CNS.

3.2.4. Heart on chip

Heart on chip was developed to imitate the contractility and electrophysiological response of heart in *in vitro* condition. Microfluidics has previous applications *in vitro* on cardiomyocytes, which generates the electrical impulse that controls the heart rate. However, these previous experiments could not fully reconstruct the tissue microenvironments, such as the propagation of an action potential (AP) or generation of contractions. To fulfill specific needs of heart-on-chip studies, a biohybrid construct was designed based on muscular thin films (MTFs); a tissue-engineered myocardium consist of anisotropic cardiomyocytes cultured on a deformable elastic thin film with various geometries [100, 101].

Grosberg et al. was pioneer in developing MTF-based “heart-on-a-chip” system that successfully measured the contractility of neonatal rat ventricular cardiomyocytes exposed to various doses of epinephrine [100]. Eight separate MTFs were framed the skeleton of their system and was fabricated in batches enabling them to collect data from multiple tissues simultaneously in the same experiment. This heart-on-chip system mimicked the hierarchical tissue architecture of laminar cardiac muscle, and measurements of structure-function relationships, including contractility, AP propagation and cytoskeletal architecture. In another approach, Agarwal et al. explored an optimized semiautomated microdevice to test the positive inotropic effect of different dosages of isoproterenol on cardiac muscle contractility. They achieved an

increased drug-screening throughput with their device having 35 separate thin films (**Figure 14a**) [102]. Basic components of this device includes a semiautomatic microdevice integrated an MTF chip, an electrode for electric field simulation, a metallic base on a heating element as temperature control unit and a transparent window for cantilever deformation monitoring. As these models were based on animal tissues and cannot recapitulate human system with precision. To overcome this limitation, Mathur et al. designed cardiac microphysiological system (MPS) that could imitate the human myocardium and envisage the cardiotoxicity of drugs accurately, by merging hiPSC-derived (human-induced pluripotent stem cells (hiPSC)) cardiomyocytes with an appropriate microarchitecture and “tissue-like” drug gradients (**Figure 14b**) [103]. These hiPSC-derived cardiac MPS predicted drug response and toxicity *in vitro* and showed a wide applicability for disease modeling and drug screening [82, 103]. Few reports are also available to tackle this complex yet vital organ of our system [104].

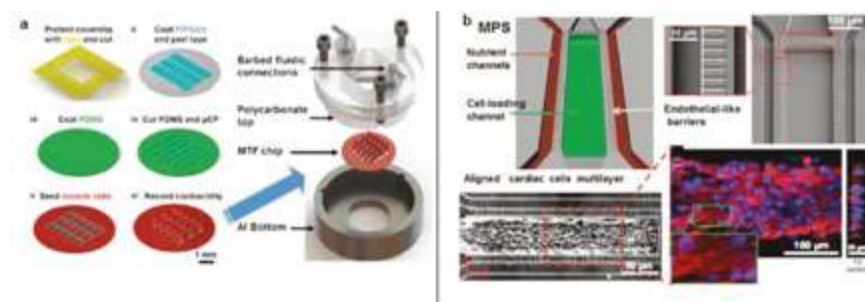

Figure 14. (a) Graphical illustration of the fabrication process flow for muscular thin film (MTF) and the semiautomatic microdevice integrated a MTF chip [102]. (b) Schematic of the microphysiological system (MPS) with nutrient channels (red), cell-loading channel (green) and 2 μm endothelial-like barriers. Optical and confocal fluorescence imaging of 3D cardiac tissue aligned with multiple hiPSC cardiac cells layer [103].

3.2.5. Stem cells on chip

Human stem cells are a critical component for OOC devices. Few reports are available where stems cells were grown in scaffolds and microarrays. These controlled conditions make it possible to mimic the complex structures and cellular interactions within and between different cell types and organs *in vivo* and keep the culture viable over long periods of time. It was reported that neurogenesis of human mesenchymal stem cells can occur in the absence of chemical stimuli, simply through the substrate stiffness [105]. **Figure 15a** is illustrating a PDMS membrane-based platform for stem cells growth.

In principle, all cell sources, whether primary cells (directly taken from an organ or tissue, e.g., by means of a biopsy needle), or cells or in the form of cell lines, from animal or human origin, can be useful for the OOC approach. The basic criterion for selecting the stem cells for OOC is target disease. For the diseases with well-known gene mutation, the DNA, specific disease-causing DNA mutation can be introduced into a stem cell line by the technique of homologous

recombination, resulting in two human cell lines with one having disease-causing DNA mutation in one of them. For this purpose, both hES (human stem cells) and iPSC (induced pluripotent stem cells) sources can in principle be used. On the other hand, for diseases caused by a whole spectrum of mutations in any part of the disease-causing gene, or diseases associated with a more complex genetic background, iPSC cell line or adult stem cells derived from a patient with the disease need to be used to recreate “the patient”—on a chip. iPSC cells are the first choice in contrast to adult stem cells, due to ease of regeneration [106].

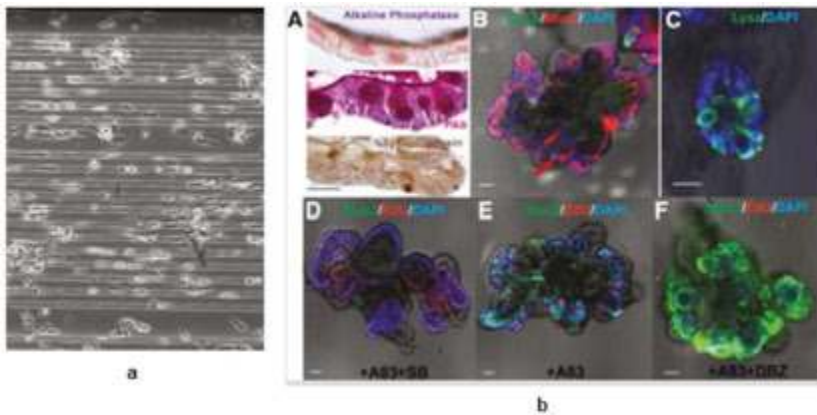

Figure 15. (a) PDMS based on-chip platform for stem cells. (b) Crypt-villus structures grown from single LGR5 positive adult stem cells from the intestinal crypt [106].

Three-dimensional “organoid” stem-cell culture technology was developed in the laboratory of Hans Clevers at the Hubrecht Institute. In this approach, intestinal stem cells were isolated from the intestinal epithelial tissue by separating tissue cells from each other. Subsequently, few stem cells within the cell mixture were identified by coupling them to a specific fluorescent antibody, followed by isolation with a fluorescence-activated cell sorter. 3D environment was created by the gel surrounding the cells to make them feel comfortable in their new “niche.” In this process of cell growth, the stem cells were bound to their “mate,” which is necessary to provide the essential cell-cell contact to start the self-renewal process. Once in the dish, each cell combination starts to self-assemble, a new crypt-villus structure in three dimensions forms called organoids (Figure 15b).

3.3. Anatomy-based organ function mimicking

As described in previous section, microengineering platforms evolved as critical methods for the fabrication of various models of organs in the biomedical sciences. Newer inventions in this field are reported to generate patterns of complex microstructures with precise control of fluid dynamics and incorporation of specific biological element that simulates organ functions directly. In this segment, few OOC devices based on anatomical mimicking will be described.

3.3.1. Spleen on chip

Spleen is a secondary lymphoid organ for selective filtration of damaged RBCs and infectious microbes including *Plasmodium* parasites [107]. Keeping in mind its special role in filtration and to understand its functionally in deeper sense, it was critical to design an OOC with high precision and accuracy. Spleen consists of white pulp, red pulp, and the marginal zone and slow blood microcirculation through the reticular meshwork of the splenic red pulp with increasing hematocrit is the prime reason of its unique filtering capacity that facilitates specialized macrophages in recognizing and destroying unhealthy RBCs [108]. Rigat-Brugarolas et al. designed a novel microdevice to copy the physical properties and hydrodynamic forces of the spleen; the minimal functional unit of the red pulp able to maintain filtering functions (**Figure 16a**) [108]. Their design consists of two main microfluidic channels for flow division to mimic the closed fast and the open slow microcirculations of spleen. The junction between slow-flow and fast-flow channel was arranged with parallel $2\ \mu\text{m}$ microconstrictions resembling the IES to constrain cells. This device could precisely reproduce the natural physiochemical conditions of spleen and the unique characteristic of distinguishing different RBCs based on their mechanical properties.

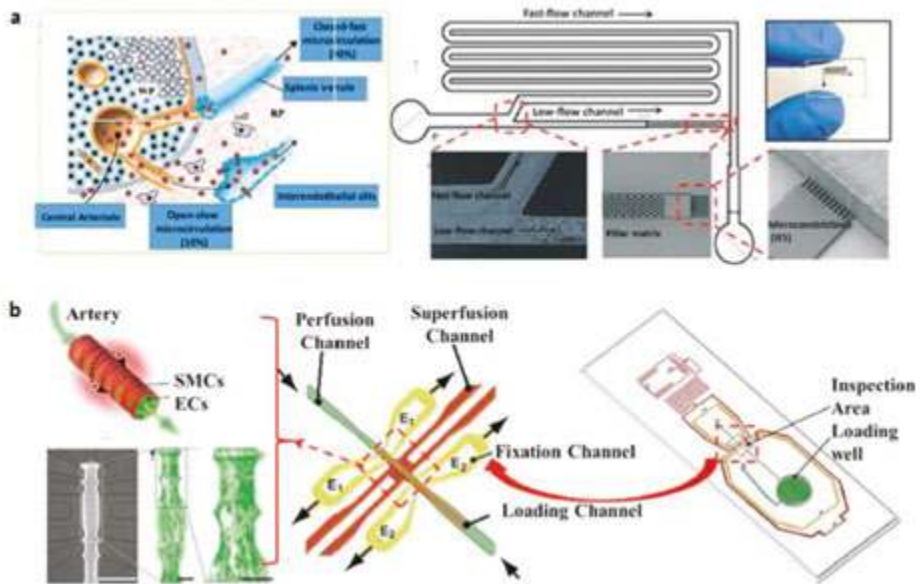

Figure 16. Spleen on a chip: (a-left) Diagram of the human spleen showing the closed-fast and open-slow microcirculations as well as the interendothelial slits (IES); (a-right) Schematic representation of flow division zone, the pillar matrix and microchannels within slow-flow channel to mimic IES, respectively [108], (b) Artery on a chip: Schematic representation of a resistance artery segment on a chip contains a microchannel network, an artery loading well and an artery inspection area. ECs and SMCs represent the endothelial cells and smooth muscle cells, respectively [110].

3.3.2. Blood vessel on chip

Arteries or blood vessels transport the blood in human body. Geometry of vasculature and accumulation of particles inside the vessels varies with the pathological changes in the structure and function of small blood vessels, which leads to cardiovascular diseases [109]. Scalable approaches to assess the structure and function of intact cardiovascular tissues in health and disease will be crucial for developing better treatment strategies. Fluid shear stress and cyclic stretch are other parameters that should be taken into account while designing *in vitro* vessels on-chip systems.

Typically, most of the current systems contain small arteries mounted on two wires or perfused with glass micropipettes that suffer from the disadvantages of nonscalability and need of a skilled person to operate. To overcome this barrier, Gunther et al. presented a scalable organ-based microfluidic platform for loading, precise placement, fixation as well as controlled perfusion and superperfusion of a fragile resistance artery segment (**Figure 16b**) [110]. This device was comprised of three parts: the artery-loading area, a microchannel network and a separate artery inspection area, connected to a thermoelectric heater and a thermoresistor to maintain the temperature at 37°C. Resistance arteries had specialized structures with 30–300 µm diameters to regulate the flow and redistribution of blood in organs. As depicted, the setup was located in the terminal sections of the arterial vascular tree, and their walls are composed of a single layer of lining endothelial cells (ECs) and several layers of circumferentially arranged smooth muscle cells (SMCs). This device although could not replicate the full functionality but showed a unique property to analyze small artery structure and function through exposure to a well-defined heterogeneous spatiotemporal microenvironment.

In another approach by Zhang et al., cyclic stretching of vesicular endothelial cells can be studied. They designed a two-layered microsystem with upper microfluidics layer and bottom groove layer separated by an elastic membrane to provide cyclic stretch (**Figure 17**). A vacuum pump was integrated with the device to apply suction pressure on membrane resulting in cyclic stretch [111].

3.4. Perfusion-based on-chip systems

Cell-cell interactions are vital for maintaining tissue structure and function, and many cells respond to both homotypic and heterotypic interactions. Combining fluid flow and mechanical forcing regimens as in *in vivo* cellular environment can improve tissue- and organ-specific functions [66]. In this section, we describe few microengineering systems for liver, brain and womb that were designed for better understanding of mechanism of cellular interactions [82].

3.4.1. Liver on chip

Liver is considered to be one of the versatile organ performing thousands of functions that include detoxification, protein synthesis, hormone production, glycogen storage, etc. It is also a key player in human drug interaction and a trivial target for drug-induced toxicity.

Liver possess a complex structure and hepatic lobule is its prime functional unit consisting of hepatocytes, blood vessels, sinusoids and Kupffer cells. [112]. Hepatocytes are crucial con-

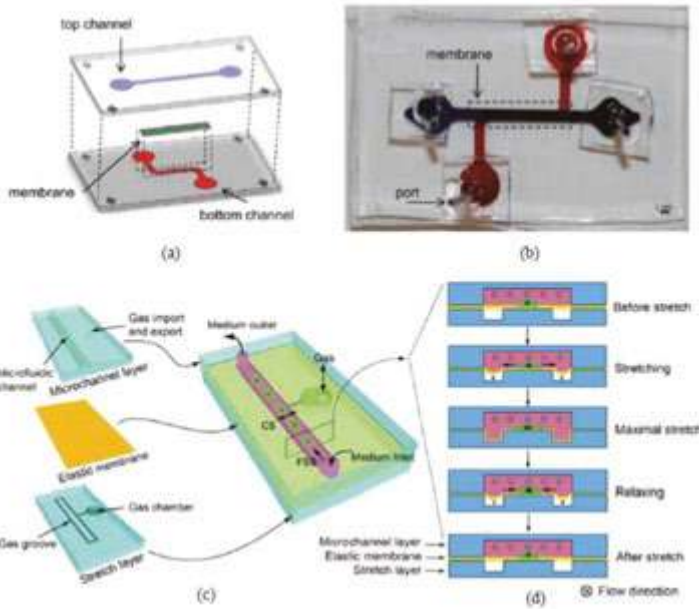

Figure 17. Schematic of blood vessel on chip. (a) PDMS chambers connected by a membrane, (b) Fabricated device, (c) Microfluidic channel for consecutive flow, (d) Stretching and relaxed elastic membrane [111].

tributors to liver functions and necessary for understanding the metabolism of xenobiotics and possible hepatotoxic effects in pharmacology. However, hepatocytes lack proliferative properties and biological interactions, which makes it rather difficult to maintain the liver-specific function of these cells *in vitro*. As a solution to this barrier, Kane et al. demonstrated a microfluidic array with wells capable of supporting micropatterned primary rat hepatocytes in coculture with 3T3-J2 fibroblasts [113]. In this process, under continuous perfusion with medium and oxygen, the synthetic and metabolic capacity of hepatocytes were preserved as evidenced by the continuous and steady synthesis of albumin and production of urea.

In other approach by Du et al., encapsulated hepatocytes that were produced with recombinant protein, with endothelial cells, differentiating them from hiPSCs within specific niches in multicomponent hydrogel fibers and further assembled into 3D-patterned endothelialized liver tissue constructs [114]. Endothelial cells significantly improved the function of hepatocytes *in vitro* and when tested on a mouse model of partial hepatectomy, an improved vascularization of the fiber scaffold was observed.

A miniaturized, multiwall coculture system for human hepatocytes surrounded by fibroblasts with optimized microscale architecture that maintained the typical phenotypic functions of the hepatocytes for several weeks was reported by Bhatia et al. Another device comprised of three sections, including a central channel for hepatocytes, a microfluidics convection channels and a microfluidics sinusoid barrier with a set of narrow channels to model epithelial cells as

show in **Figure 18a** [115]. This model succeeded in mimicking the transportation between blood flow and hepatocytes and the shear stress experienced by hepatocytes.

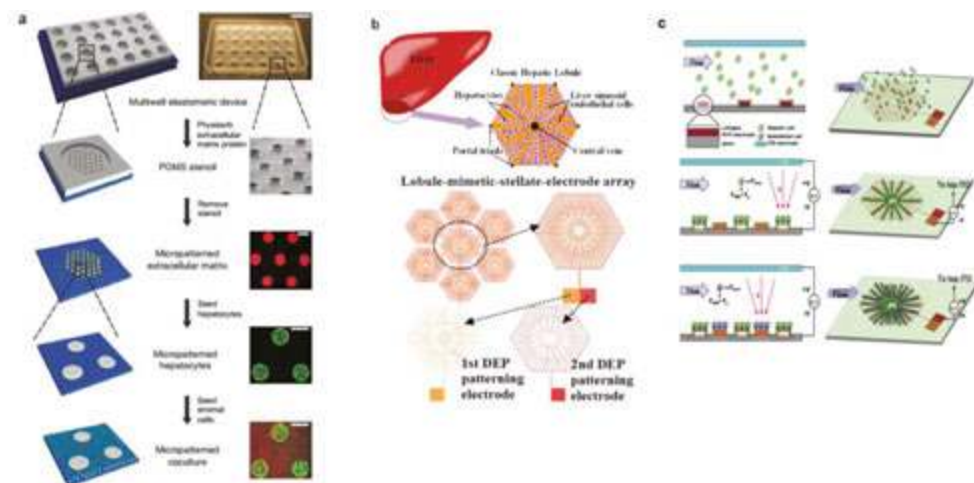

Figure 18. (a) Schematic of soft lithographic process to fabricate microscale multiwell format for primary hepatocytes that selectively adhere to matrix-coated domains and coculture with fibroblasts seeded on bare areas [115]. (b) Configuration of one basic unit of liver tissue, the classic hepatic lobule and lobule-mimetic-stellate-electrodes array. (c) The configuration and operation principles of DEP-based heterogeneous lobule-mimetic cell patterning [116].

Another research, also based on hepatocytes-based model, was done by Ho et al., where they designed an array of concentric-stellate-tip microelectrodes to mimic the lobular structure of liver tissues (**Figure 18b, c**) [116]. This device was comprised of vertical microelectrodes or lobule-mimicking stellate electrode arrays, to achieve 3D liver cell patterning by separately snaring hepatocytes and endothelial cells that were manipulated under patterned electric fields via dielectrophoresis (DEP). Few other researchers (i.e., Feng et al. [117], Wong et al. [118], Lee et al. [119]) have also put forth their proof of concepts based on hepatocytes. Wong et al. developed a concave microwell-based size controllable spheroidal “hepatosphere” and “heterosphere” models by monoculturing primary hepatocytes and by coculturing primary hepatocytes and hepatic stellate cells (HSCs), respectively, to monitor the effect of HSCs in controlling the formation of tight cell-cell contacts and final organization of the spheroidal aggregates [118, 82].

Some other reports are also there where researcher came forward with their ideas to design efficient liver on-chip devices for drug screening and toxicity analysis [98, 120–122].

Recently, Lee et al. have designed a novel liver on-chip system based on liver microsomes that were encapsulated in 3D hydrogel matrix to mimic the metabolism reactions and the transport phenomena in the liver. Photopolymerization of poly(ethylene glycol) diacrylate (PEG-DA) allowed controlling the mass transfer with matrix sizes. To reproduce the blood flow through liver, gravity-induced passive flow was explored. They measured the reaction kinetics of P450

enzymes in the device and simulated the convection-diffusion-reaction characteristics inside the device with a mathematical model [123]. **Figure 19a** is illustrating the schematic and design of on-chip liver platform. Although there were several factors to be modified for improved reaction kinetic data such as diffusion limitation, optimization of convection and mixing, reducing the nonspecific binding to PDMS surface, preliminary analysis shows great potential and this device will be further explored for the metabolism of various compounds in liver [123].

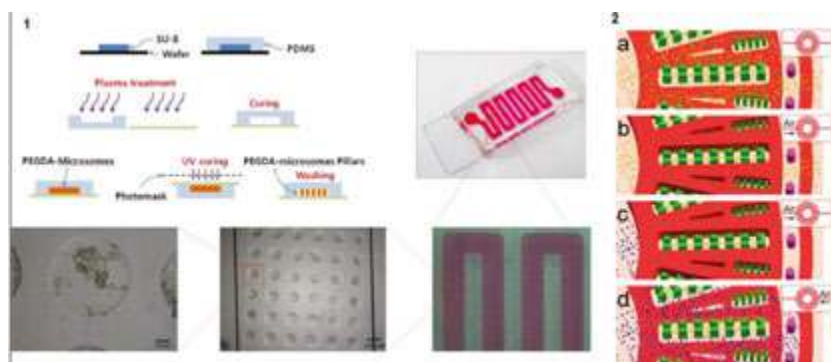

Figure 19. (1) Schematic of PDMS chip fabrication method and picture of fabricated chip (size of the glass slide was 25 mm by 75 mm) [123]. (2) Schematic diagram illustrating the sequential procedure for constructing the biomimetic microtissue [124].

Most of the on-chip liver platforms are based on hepatocytes, and generally, these *in vitro* hepatocyte culture systems imitated the structure of the hepatic cord or can be applied for studying specific aspects of toxicity. However, to imitate advanced liver architectures (i.e., hepatic sinusoids) that could preserve cell-cell and cell-ECM interactions, these existing devices did not solve the purpose. To overcome this limitation, Ma et al designed a microfluidics-based biomimetic method for *in vitro* fabrication of a 3D liver lobule such as microtissue. Their system was composed of a radially patterned hepatic cord-like network and an intrinsic hepatic sinusoid-like network as shown in **Figure 19b**. This device showed that the 3D biomimetic liver lobule-like microtissue retained higher basal liver-specific functions in Phase I/II (i.e., CYP-1A1/2 and UGT activities) and more sensitive response was obtained for pharmacological inducers/inhibitors than the 2D and 3D monocultures of HepG2 cells. This device was tested for three model drugs—acetaminophen, isoniazid and rifampicin and a high hepatic capacity for drug metabolism was exhibited by biomimetic microtissue that indicated that microtissue, designed by Ma et al. can be explored as a promising platform for *in vitro* toxicity of drugs [124].

3.4.2. Brain on chip

Human brain is the most complex structure and the quest to understand how it stores and processes information leads researchers to the application of new microengineering technologies to design *in vitro* model of brain. Unraveling the basic concepts could be beneficial for

neural diseases, development of improved brain-machine interfaces and domain of machine-learning will be totally revolutionized. A brain-oriented paradigm shift has occurred with the advances in neuroscience and OOC systems [131, 132].

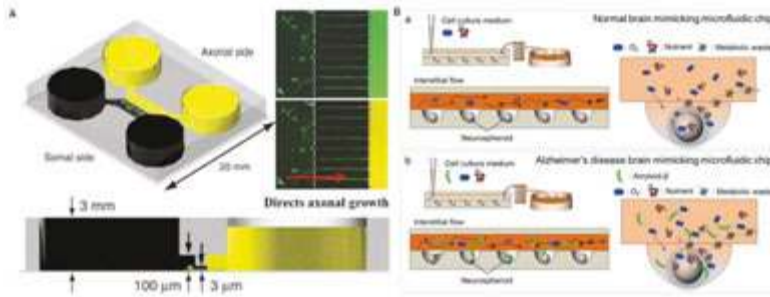

Figure 20. (A) The microfluidic-based culture platform directs axonal growth of CNS neurons and fluidically isolates axons [125]. (B) Schematic diagrams of normal brain mimicking microfluidic chip (a) and Alzheimer's disease brain mimicking microfluidic chip [127].

We discussed earlier various other OOC but owing to its structural and functional hierarchy, high specialization and constant metabolic demand to design a complete *in vitro* brain model is difficult. The prime limiting factors are used to identify the smallest structural and functional unit, ion channels or synapses in the microenvironment [126]. Researchers from all over the world give different experimental models of circular microfluidic compartmentalized coculture platforms to study brain development and degeneration based on physiological neuron connection architecture. A microfluidic culture platform was demonstrated by Taylor et al, consist of a relief pattern of somal and axonal compartments connected by microgrooves that function in directing, isolation and biochemical analysis of CNS axons (**Figure 20a**) [125]. In another work, Park et al describe a microfluidic chip based on 3D neurospheroids that more closely mimics the *in vivo* brain microenvironment and provides a constant flow of fluid similar in the interstitial space of the brain. Concave microwell arrays were explored for the formation of uniform neurospheroids, with cell-cell interactions and contacts in all directions while osmotic micropump was used to maintain the slow interstitial level of flow. Using this platform, effect of flow on neurospheroid size, neural network and neural differentiation was investigated via this *in vitro* platform. Larger sizes of neurospheroids were obtained and formed more robust and complex neural networks than those cultured under static conditions. This finding proved the effect of the interstitial level of slow and diffusion-dominant flow on continuous nutrient, oxygen and cytokine transport and removal of metabolic wastes [127]. This chip was designed to detect the toxic effect of β -amyloid; a major contributor of Alzheimer's disease. **Figure 20b** is showing the schematic of this unique platform for neurodegenerative disease diagnostic. Kato-Negishi et al. came up with a millimeter-sized neural building block to reconstruct 3D broad neural networks connecting with different neurons [128]. Peyrin et al. also described a microfluidic system involving several different neuron subtypes separated into two individual chambers with asymmetrical connection architecture

of funnel-shaped microchannels to reconstruct oriented neuronal networks [129]. This device was a kind of diode that operated as direction selective filter where axonal projections can be penetrated by axons in a single direction and as an impermeable barrier for cell bodies. In this point, Kunze et al. demonstrated a 3D microfluidic device for creating physiologically realistic, micrometer scaled neural cell multilayers in an alginate-enriched agarose scaffold [82, 130].

A method to fabricate neurospheres networking with nerve-like structure using concave well arrays connected by the hemicylindrical channels was illustrated by Jeong et al. This method provides the topological effect of the concave-well hemicylindrical-channel-networking, which is crucial in guided outgrowth of neuronal network [131]. Similar hemicylindrical systems were also explored to generate 3D nerve-like neural bundles between neural spheroids and neighboring satellite spheroids in concave channels [132].

3.4.3. Breast and womb on chip

Breast cancer is still the cause of concern and with the advancement of microfabrication techniques, improved detection and therapy of breast neoplasia can be obtained via nanodevices traveling inside mammary ducts. However, the decreasing size of branched mammary ducts prevents access to remote areas of the ductal system using a pressure-driven fluid-based approach. Magnetic field guidance of superparamagnetic submicron particles (SMPs) in a stationary fluid might provide a possible alternative but it is critical to first reproduce the breast ductal system to assess the use of such devices for future therapeutic and diagnostic (“theranostic”) purposes. Graften et al. came up with an idea of to engineer a portion of a breast ductal system using polydimethylsiloxane (PDMS) microfluidic channels of decreasing sizes with a total volume of 0.09 mL. A magnet was used to move superparamagnetic/fluorescent SMPs through a static fluid inside the microchannels [133]. **Figure 21a** is the schematic of PDMS on chip assembly. This device can be explored for the early detection of ductal breast cancer and consisted of basoapically polarized monolayer of luminal cells only as the device imitated the luminal portion of the ductal breast system only and myoepithelial cells at the basal side of the luminal cells and terminal ductal lobular units at the ends of the narrowest channels were not included. Apart from breast on chip, womb OOC was also developed by Chang et al. with the objective to deal with infertility.

In recent years, a genuine increase in infertility has been observed due to diverse factors, including stress, environmental pollution and increase in age, smoking, consumption of alcohol, sexually transmitted diseases, etc. *In vitro* fertilization (IVF), a state-of-the-art technology, enhances the rate of pregnancy. As a procedure, fertilized eggs in the blastocyst stage are transferred to the woman’s uterus for implantation and further development and efforts are made to improve the culture environment of the preimplantation embryos and developing specialized culture surfaces to enhance the success rate of this technique [134, 135].

Due to the failure of static culture systems to mimic the dynamic fluid environment in the fallopian tube [136], dynamic culture platforms that explored shaking/rotation [137], controlled fluid flow [138] and vibration [139] models were studied for use in embryonic development where method of coculturing embryos with endometrial was done to overcome developmental arrest of early embryos in single culture. Although these methods showed enhanced perform-

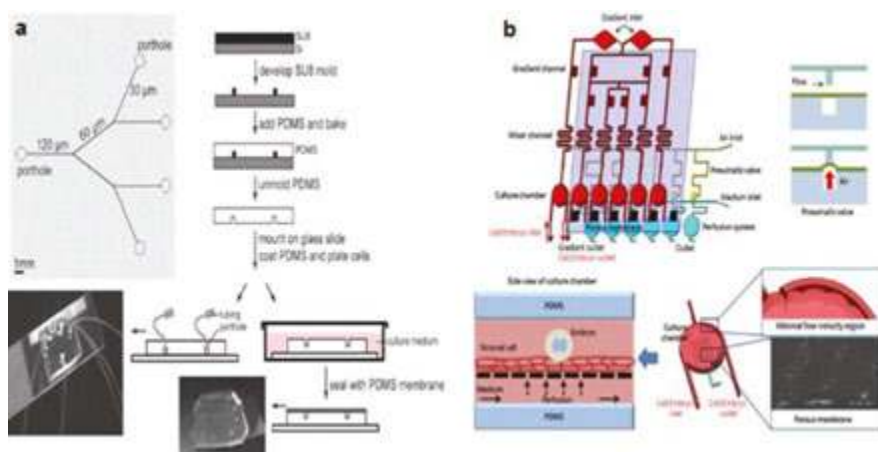

Figure 21. (a) Schematic of breast on chip [133], (b) PDMS-based embryo coculture microchip, where the concentration gradient generator is integrated with a mixer and a cell culture chamber on the top [140].

ance and beneficial effects of coculturing on the development of mammalian, they could not be considered as a complete on chip system for womb. Recently, Chang et al. also designed an autologous 3D perfusion platform as a necessary approach to deal with IVF and partly mimic the physiological function of the reproductive system [140]. This device as shown in **Figure 21b** is comprised of an upstream concentration gradient generator (width: 250 μm , height: 230 μm) was integrated with a diamond-shaped passive micromixer (width: 200 μm , height: 230 μm) that could generate six different homogeneous concentrations of progesterone. Micromixer was used to increase the contact area between liquid molecules and to provide enhanced mixing efficiency by its continuous splitting and mixing of liquids. The main specifications and goals of this microfluidic channel design was as follows: (i) Gradient distribution for specific concentrations of steroid hormones in six culture chambers, (ii) Maintaining homogenous concentrations of steroid hormones in individual chamber, (iii) Preserve uniform culture conditions with respect to the flow speed/rate by constant flow speed/rate for the chambers.

This womb-on-chip platform showed the ability to replace the present embryo culture platforms used for assisting *in vitro* fertilization.

3.5. Human on chip

Organ-on-chip concept is in its nascent state and despite of the substantial advances in the creation of microengineered tissue and organ models, a lot is left to explore for recreating complex 3D models that could reconstitute the whole organ metabolism and physiology. With the recent advances in tissue engineering, microfabrication techniques, researchers are now focusing on multiorgan-on-chip devices that could imitate complete human on chip up to some extent if not fully [141, 142]. Figure shows a body-on-chip systems.

Although complete functional body-on-chip devices are still far from reach but the latest development in this field has given a glimpse of promising future of this revolutionary field of biomedicine. **Figure 22** shows the concept of body-on-chip microsystem [4].

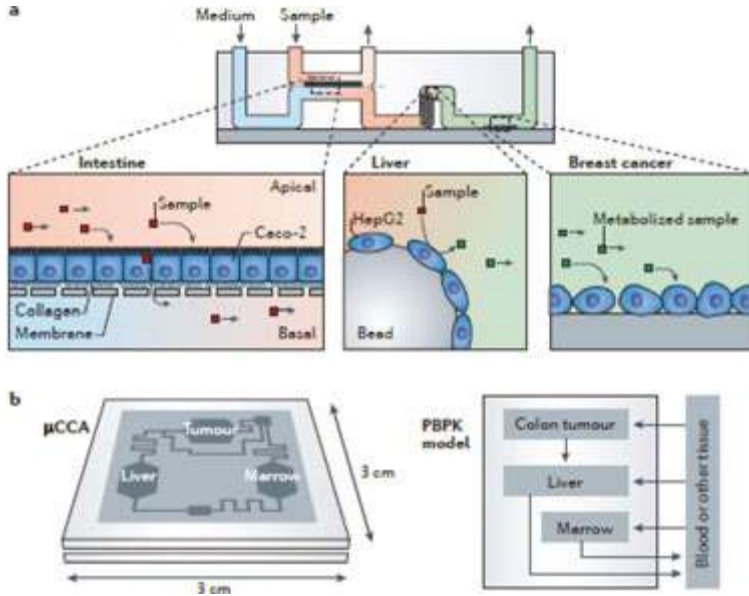

Figure 22. Schematic of a body on chip system. (a) A microdevice containing interconnected cell culture microchambers integrated with microfluidic culture of intestinal epithelial, hepatocytes and breast cancer cells. (b) A micro cell culture analog (μ CCA) representing a colon tumor, the bone marrow and liver [4].

4. Pharmaceutical applications and future prospects of organ-on-chip devices

The field of OOC devices is still in its infancy, although it is a rapidly growing research arena with lots of future potential in biomedicine from understanding the mechanism of complex organ architectures to drug discovery. Earlier studies revealed that while 3D cell cultures were far more superior planar than conventional 2D models due to their better control over cell differentiation, ECM mechanical compliance and a much better response was obtained in terms of tissue- and organ-level functionality by combining microengineering with cell biology. Fortunately, with the recent advances in microfabrication strategies and microfluidics, precise dynamic control of structure, mechanics and chemical delivery at the cellular size scale can be achieved. Microengineered 3D cell culture models, and particularly more sophisticated OOC microdevices, have many potential applications, including disease research and drug

discovery, but in this section, we mainly focus on OOC application relevant to pharmaceutical industry.

The pharmaceutical industry is under intense pressure economically, ethically and scientifically to find ways to accelerate the drug-development process, and to develop drugs that are safer and more effective in humans at a lower cost. Traditional animal testing approaches are expensive and often fail to predict human toxicity or efficacy of drugs; in fact, nowadays, questions are arising with regard to the significance of animals testing if they cannot reliably predict clinical outcomes [4, 143]. As correctly suggested by Dr. Ingber, Founder Director-Harvard's Wyss Institute for Biologically Inspired Engineering that chips respond to drugs like human organs do—and have the potential to replace animal testing for safety and efficacy early in the drug-development process.

4.1. Bottlenecks in drug discovery process

4.1.1. High cost of compound testing

Modern drug development requires implementation of extensive preclinical testing and validation protocols before getting the formal approval to progress to clinical evaluation of the compound. This process is tedious and costly and a single compound can cost more than \$2 million. Moreover, every 10 drugs entering clinical trials, generally only one or two would be licensed for eventual use in humans [2].

4.1.2. Lack of exact simulation of human systems in static 2D cells culture

The lack of preclinical model systems to provide accurate predictions of human responses to novel therapeutic drugs is another critical limiting factor in drug discovery. The current gold standard for laboratory-based preclinical evaluation is based on *in vitro* cell culture assay and *in vivo* animal model experimentation and assessment. Although cell culture assays have advantage of controlled environments where cellular maturation and activity are easily observed and tested, they lack the complexity of living systems and are incapable of mimicking the conditions of organ-organ or tissue-tissue communication. This simplicity is a major drawback in drug-development studies since drug metabolism and the effect of metabolite activity on nontarget tissues cannot be predicted [3].

4.1.3. Time period of animal studies and loss of numerous animal lives

Another crucial limiting factor is time involved in *in vivo* studies. Although animal studies can somehow better predict the drug metabolism and response as animal models maintain the intricacy of living systems and assessment of organ-organ crosstalk and nontarget organ toxicity is possible, these models on multiple occasions, been proven to be wrong predictors of human responses to drug treatment. Human system is more complex and developed than laboratory animals and the response and mechanisms are different for many therapeutic agents. The hypothesis that favorable outcomes observed in animals will translate to human

patients has led to clinical situations where treatments have proved futile or even detrimental to patient well-being and recovery [3, 144].

4.1.4. Lack of accurate prediction of clinical response and diminished number of new drugs for patients

As discussed earlier, due to inadequate *in vitro* data and practical difficulties of *in vivo* studies, the clinical response is not always as expected. Eroom's law (Moore's law backwards) states that "the number of new medicines *halves* every nine years," despite an "astronomical" increase in research funding from government and industry. This situation exists in large part because the traditional journey from drug discovery to drug development still occurs mostly in 2D static cell cultures and animal studies, which are not the true predictors of response of new compounds in the human body resulting in failure of approximately 85% of therapies in clinical trials and of those that make it to advanced phase III, generally the last step before regulatory approval, only half are actually approved. This data itself ignites concerns for the pharma industry and how to expedite the current drug discovery scenario [149].

Microengineered cell culture systems that mimic complex organ physiology have the potential to be used for the development of *in vitro* human-relevant disease models. These are more predictive of drug efficacy and toxicity in patients and can provide better insight into drug mechanism of action. OOC devices provide compelling advantages over other *in vitro* cell culture models for the evaluation of drug safety and metabolism. In broader sense, *in vitro* assays incorporating cultured human cells can act as savior in identifying environmental toxins and providing better understanding of their mechanisms of action, as well as improving our ability to predict risks for specific compounds. In addition, the ability to integrate functional organ mimetics, such as gut, liver, lung and skin-on-chips within a "human-on-a-chip," the interplay of different organs in determining pharmacokinetic properties of compounds can be monitored [3, 145].

4.2. Role of organ-on-chip devices in drug discovery

4.2.1. Reduction in cost

The drug-development process is costly in the phases of clinical trials, which can cost millions of dollars. However, despite extensive animal testing of drugs before starting a clinical trial with humans, many drugs fail because of low efficacy or unexpected toxic side effects not predicted with earlier trials. In this regard, the most promising advantage of body-on-a-chip devices is that the devices can mimic both animal and human metabolism and predict differences between them that will allow for a higher level of accuracy when predicting the outcome of clinical trials. Moreover, any toxicity observed before human trial with *in vitro* on chip systems can prevent unsuitable drug candidates from entering the expensive phase of clinical trials that limit costs and unrealistic expectations.

Body-on-a-chip devices are low-cost platforms that can substantially reduce the cost of drug testing.

4.2.2. Drug-target identification

Organs-on-chips have the potential to serve as a new enabling platform to identify and validate the effectiveness, safety of potential targets early in the pipeline to increase the likelihood of success in clinical trials [4]. Song et al has recently a microengineered model of vasculature to mechanistically examine chemokine-mediated interactions between circulating breast cancer cells and the microvascular endothelium that induced site-specific basal stimulations and activation of the microfluidic endothelium by introducing chemokines into the lower chambers. Through quantitative analysis of cancer cell attachment to the endothelium and the levels of cell surface receptor expression, this system predicted that endothelial recruitment of breast cancer cells induced by a chemokine-CXC-chemokine ligand 12 (CXCL12), involved in cancer metastasis, is mediated by the endothelial receptor CXCR4 and this response is independent of the expression of CXCL12 receptors on circulating cancer cells. These findings gave a new insight into critical role of the vascular endothelium in the metastatic behavior of circulating tumor cells and how to control and manipulate a biological target to analyze a functional outcome of target modulation. This discovery related with OOC model was an important breakthrough in indentifying a valid therapeutic target for preventing cancer metastasis [146].

Other studies on OOC platforms for understanding of molecular mechanisms of cell-cell interactions, mitochondrial cardiomyopathy of Barth syndrome, and drug-induced toxicities in pulmonary edema have also been successfully performed [147–149].

4.2.3. Toxicity and drug efficacy evaluation

This a very important aspect of drug research as toxicity analysis is utmost important for any new therapeutic agent. Liver and kidney tissues are of great interest to drug developers due to their predominant role during the absorption, distribution, metabolism and excretion (ADME) process of a drug [3]. Physiologically, drug is metabolized mainly in the liver while kidney deals with their elimination. These two critical processes make these two organs highly susceptible to drug injury. In a coculture bio-analytical microplatform of liver-kidney, toxicity of anticancer drug ifosfamide illustrated the importance of the liver-kidney interaction. Ifosfamide is a prodrug, activated in body system by CYP450 enzymes in the liver, but some of its metabolites, such as chloroacetaldehyde, are nephrotoxic. With this model of highly differentiated liver cells (HepaRG), perturbation of cell proliferation and calcium release in the kidney tissue could be monitored that was not possible with the single culture. Previously, the same group simulated the performance of hepatocytes on-chip system coupled with NMR for toxicity analysis of flutamide [149, 150].

These contributions signify the role of on-chip systems for toxicity analysis of drug *in vitro* that is an important step for clinical trials.

Multiorgan interactions in drug testing and their importance were highlighted by Sung et al. also. They studied the dose response and efficacy of 5-fluorouracil (5-FU) on a system containing system that contained liver cells (HepG2/C3A), colon cancer cells (HCT-116) and myeloblasts (Kasumi-1) [151]. They monitored the degradation phenomenon of 5-Fu and effect

of its pro drug Tegafur and uracil-a competitive inhibitor of 5-Fu for the dose response and bioavailability.

Predicting the bioavailability of a drug accurately can be difficult with animal models. Multiorgan microdevices that contain a combination of the gastrointestinal tract epithelium and the liver at the appropriate sizes and with realistic liquid-to-cell ratios have the potential to predict the bioavailability of ingested drugs [152].

4.2.4. Drug screening

The absence of predicted therapeutic effects of a drug or increased dose levels is the major cause of drug toxicity. The failure of existing methods to accurately predict *in vivo* drug efficacy before clinical trials give rise to the undesirable outcomes. Human OOC models can become instrumental in addressing these existing imitations [4].

The potential of OOC approaches for testing drug efficacy was recently explored by Aref et al. in a microengineered 3D assay of epithelial-mesenchymal transition (EMT) during cancer progression [153]. By culturing lung cancer spheroids in a 3D matrix gel adjacent to an endothelialized microchannel, this model recapitulated EMT-induced tumor dispersion and phenotypic changes in cancer cells in an endothelial cell-dependent manner. Twelve drugs ranging from prospective drugs to US Food and Drug Administration (FDA)-approved drugs were screened into the vascular channel, and their ability to inhibit EMT was analyzed by direct visualization of the cancer spheroids.

The results obtained for drugs efficacy in cancer treatment by on-chip systems, significantly varies from 2D static culture and were in close proximity with human clinical trials. This study concluded that such OOC systems will be developed as a more realistic platform for efficacy and to decide for advanced trails, a major step toward drug discovery.

4.2.5. Response of combination of drugs

Since microdevices are relatively inexpensive, and many such devices will be operated in parallel, it is possible to test many drugs and combinations of drugs at different concentrations with devices. Testing combinations of drugs is useful to monitor drug interactions and cross talks. Synergistic interactions are of particular interest. Another benefit of such studies is that the drugs having similar functions, but different side effects could potentially be combined at reduced dosages to achieve the needed tissue response. These multiorgan on-chip systems can play a major role to design individualized therapy regimen for patients that do not respond to routinely used drug combinations as a synergistic effect and dose of different drug combination can be predicted.

4.2.6. Pharmacokinetics and body on-chip systems

Physiologically based pharmacokinetic models (PBPKs) are mathematical models that are used to extrapolate data from animal experiments and predict human response to a drug. These models mainly rely on existing understanding and knowledge of a drug's metabolism from

traditional 2D static cultures and animal studies and as we discussed, these methods are not the accurate predictors. This is the reason for the equations used in a PBPK are not complete and the models are not accurate. Multiorgan microdevices can be modeled more precisely with PBPKs and divergence between the model's prediction and experimental data obtained with the devices can enhance our understanding of human response to a wide variety of combination of inputs with higher accuracy than before.

To generate a precise PBPK model, for pharmacokinetics and pharmacodynamics studies, recapitulating human physiology at the whole-body level is the most crucial aspect. Researchers have begun to pursue the development of multi-organ models, and in one such study, combined models of breast cancer, the intestine and liver were designed to create a network of interconnected microfabricated cell culture chambers that exhibited the sequential absorption, metabolism and efficacy of four anticancer drugs [154]. Shuler et al [155] applied pharmacokinetic and pharmacodynamic modeling (PKPD) principles to micro cell culture analog comprising interconnected microchambers representing a colon tumor, the liver and bone marrow, which imitated the *in vivo* distribution, retention and recirculation of drug-containing blood in these organs. Hepatic metabolism-mediated cytotoxicity of the prodrug tegafur to colon cancer, liver cancer and bone marrow cells was investigated by this system. These multiorgan on-chip systems are better than the existing models and can expedite the drug discovery process by increasing the efficiency and mitigating the high cost associated with drug-development process.

4.3. Future prospects of organ-on-chip devices

As an alternative to conventional cell culture and animal models, human OOC could transform many areas of basic research and drug development. They have wide applications in research on molecular mechanisms of organ development and disease, organ-organ coupling and the interactions of the body with stimuli, such as drugs, environmental agents, consumer, products and medical devices. Due to complexities involved, OOC have limited or no applications in certain areas of biomedical research, such as chronic diseases, adaptive immune responses or complex system-level behaviors of the endocrine, skeletal and nervous systems. As described previously, OOC are effective for investigating physiological and disease processes that occur in a relatively short-time frame (less than ~1 month) and depend on relative cell positions within an organ- or tissue-specific microarchitecture [66].

OOC technology has certain technical and entrepreneurial challenges also. One of the critical technical challenges is material for fabrication—such as poly(dimethylsiloxane) (PDMS) that have gained widespread use in rapid-prototyping of OOC microdevices as most of the OOC models rely mostly on synthetic materials (e.g. PDMS, polycarbonate and polyester), the physicochemical properties of which are not appropriate for mimicking extracellular matrices *in vivo*. It is utmost important to identify new cell culture substrates to produce devices for more accurate predictions. For successful translation of OOC from proof of concept in the laboratory to commercial screening platforms, identification and optimization of new low-cost materials and fabrication strategies suitable for their mass production and integration into existing infrastructures in the pharmaceutical industry is call of time.

More reliable and sustainable sources of human cells, especially disease-specific cells that are quiescent to *in vitro* culture in OOC and phenotypically are true representative of their *in vivo* counterparts are required. To overcome this hurdle, human embryonic stem cells and iPS cells can be engineered to suit specific needs in the development of OOC [3, 156]. The OOC models with stem cells can generate and control physiologically relevant structural, biochemical and mechanical cues required for stem-cell differentiation and maturation.

With the new avenues opened by OOC in drug development, there is a need of fabricating human on-chip or multiorgan on-chip devices and to maintain a balance between the complexity and practicality will play an important role in their wide applications. With the improvement in physiological relevance, complexity in the model is obvious that presents major challenges to practical operation and management of the system. Accurate identification of minimal subset of cells and microenvironmental factors will be helpful to create a balance and designing a simplest model possible that recapitulates physiological responses of interest.

Integration of laboratory on-chip platforms with miniaturized analytical systems is also important for better detection sensitivity despite of low culture volumes and cell numbers [1].

OOCs are not universal solutions, and alternative tools will continue to be better solutions for modeling certain *in vivo* processes as animal offer whole-organism toxicity testing and this parallel analysis will be required until the current OOC scenario attains the maturity and refine human on-chip systems come into existence.

Despite their limitations, OOCs have the potential to play a transformative role across drug discovery and development. Eventually, OOC models may play a pivotal role in streamlining the clinical trial process. Due to the complexities of organ function and regulatory requirements, it is unlikely that OOCs will replace animal testing anytime soon [66].

However, with the scientific advancements, this field is evolving at a fast pace and these hurdles could be surmountable with tri-lateral partnerships between academic institutions, industry and regulatory agencies. The paradigm-shifting potential of OOC technology has been recognized by funding agencies integrated microphysiological systems [157, 158]. Pharmaceutical companies are also coming forward to establish industry- academia partnerships to jointly explore this emerging research arena and to establish themselves at the forefront of expected OOC advances. In nut shell, it is concluded that despite of several limitations, achievements in this revolutionary field of biomedicine, OOC technology present exciting new avenues for drug discovery and development and a perfect picture of a promising future.

Acknowledgements

Author is grateful to Department of Science and Technology, Government of India for providing INSPIRE Faculty award to pursue independent research.

Author details

Preeti Nigam Joshi

Address all correspondence to: ph.joshi@ncl.res.in

Organic Chemistry Division, National Chemical Laboratory, Pune, India

References

- [1] Neuzil P, Giselbrecht S, Länge K, Huang TJ, Manz A. *Nat Rev Drug Discov.* 2012; 11: 620–632. DOI: 10.1038/nrd3799
- [2] Dimasi JA, Grabowski HG. The cost of biopharmaceutical R&D: is biotech different? *Manage Decis Econ.* 2007; 28: 469–479. DOI: 10.1002/mde.1360
- [3] Esch MB, Smith A, Prot JM, Sancho CO, Hickman J, Shuler ML. *Adv Drug Deliv Rev.* 2014; 0: 158–169. DOI: 10.1016/j.addr.2013.12.003
- [4] Esch EW, Bahinski A, Huh D. *Nat Rev Drug Discov.* 2015; 14: 248–260. DOI:10.1038/nrd4539
- [5] Shamir ER, Ewald AJ. *Nat Rev Mol Cell Biol.* 2014; 15: 647–664. DOI: org/10.1016/j.tcb.2015.09.010
- [6] Whitesides GM, Ostuni E, Takayama S, Jiang XY, Ingber DE. *Annu Rev Biomed Eng.* 2001; 3: 335–373. DOI: 10.1146/annurev.bioeng.3.1.335
- [7] Craighead H. *Nature.* 2006; 442: 387–393. DOI:10.1038/nature05061
- [8] Dhaliwa A. *Mater Method.* 2012; 2: 162. DOI: <http://dx.DOIorg/10.13070/mm.en.2.162>
- [9] Yang SI, Lei KF, Tsai SW, Hsu HT. *Conf Proc IEEE Eng Med Biol Soc.* 2013; 2013: 168–171. DOI: 10.1109/EMBC.2013.6609464
- [10] Patolsky F, Zheng G, Lieber CM. *Nat Protoc.* 2006; 1: 1711–1724. DOI: 10.1038/nprot.2006.227
- [11] Zhang C, Xing D. *Nucleic Acids Res.* 2007; 35: 4223–4237. DOI: 10.1093/nar/gkm389
- [12] Ashraf MW, Tayyaba S, Afzulpurkar N. *J Mol Sci.* 2011; 12: 3648–3704. DOI: 10.3390/ijms12063648.
- [13] Wu J, Kodzius R, Cao W, Wen W. *Microchim acta.* 2013; 81: 1611–1616. DOI: 10.1007/s00604-013-1140-2
- [14] Daar AS, Thorsteinsdóttir H, Martin DK, Smith AC, Nast S, Singer PA. *Nat Genet.* 2002; 32: 229–232. DOI: 10.1038/ng1002-229

- [15] Yang J, Liu Y, Rauch CB, Stevens RL, Liu RH, Lenigk R, Grodzinski P. *Lab Chip*. 2002; 2: 179–187. DOI: 10.1039/B208405H
- [16] Zhou X, Liu D, Zhong R, Dai Z, Wu D, Wang H, Du Y, Xia Z, Zhang L, Mei X, Lin B. *Electrophoresis*. 2004; 25: 3032–3032. DOI: 10.1002/elps.200305966
- [17] Cady NC, Stelick S, Kunnavakkam MV, Batt CA. *Sens Actuat B Chem*. 2005; 107: 332–341. DOI: 10.1016/j.snb.2004.10.022
- [18] Wu J, Kodzius R, Xiao K, Qin J, Wen W. *Biomed Microdevice*. 2012; 14: 179–186. DOI: 10.1007/s10544-011-9595-6
- [19] Chia BT, Yang SA, Cheng MA, Lin CL. *IEEE 22nd International Conference*. 2009; 292–295. DOI: 10.1109/MEMSYS.2009.4805376
- [20] Steinbach C, Steinbrücker C, Pollok S, Walther K, Clement JH, Chen Y, Petersen I, Cialla-May D, Weber K, Popp J. *Analyst*. 2015; 140: 2747–2754. DOI: 10.1039/C4AN02086C
- [21] Kopp MU, Mello AJ, Manz A. *Science*. 1998; 15: 1046–1053.
- [22] Yeo LY, Chang HC, Chan PPY, Friend JR. *Small*. 2011; 7: 12–48. DOI: 10.1002/smll.201000946
- [23] Ahn CH, Choi JW, Beaucage G, Nevin JH, Lee JB, Puntambekar A, Lee JY. *Proc IEEE*. 2004; 92:154–173.
- [24] Service RF. *Science*. 1998; 282: 399–401.
- [25] Dinh T, Griffin G, Stokes D, Wintenberg A. *Sens Actuators B*. 2003; 90: 104–111. DOI: 10.1016/S0925-4005(03)00048-0
- [26] Kricka L. *Clin Chim Acta*. 2001; 307: 219–223. DOI:10.1016/S0009-8981(01)00451-X
- [27] Lauks I. *Acc Chem Res*. 1998; 31: 317–324. DOI: 10.1021/ar9700670
- [28] Ko J. *Lab Chip*. 2003; 3: 106–113. DOI: 10.1039/B301794J
- [29] Linder V. *Analyst*. 2007; 132: 1186–1192. DOI: 10.1039/B706347D
- [30] Stevens W, Gous N, Forf N, Scott LE. *BMC Medicine*2014; 12:173–180. DOI: 10.1186/s12916-014-0173-7
- [31] Choi S, Goryl M, Sin LYM, Wong PK, Chae J. *Microfluid Nanofluid* 2011; 10: 231–247. DOI: 10.1007/s10404-010-0638-8
- [32] Su W, Gao X, Jiang L, Qin J. *J Chromatograph A*. 2015; 1377: 13–26. DOI:10.1016/j.chroma.2014.12.041
- [33] Khan IU, Serra CA, Anton N, Vandamme T. *J Control Release*. 2013; 172: 1065–1074. DOI: 10.1016/j.jconrel.2013.07.028

- [34] Khan IU, Serra CA, Anton N, Vandamme T. *Expert Opin Drug Deliv.* 2015; 2: 547–562. DOI: 10.1517/17425247.2015.974547
- [35] Stadler B. *Biomicrofluidics.* 2015; 9: 052501. DOI: 10.1063/1.4931070
- [36] Hettiarachchi K, Zhang S, Feingold S, Lee AP, Dayton PA. *Biotechnol Prog* 2009; 25: 938–945. DOI: 10.1002/btpr.214
- [37] Wu Y, Li L, Mao Y, Lee LJ, *ACS Nano.* 2012; 6: 2245–2252. DOI: 10.1021/nn204300s
- [38] Jahn A, Vreeland WN, Gaitan M, Locascio LE. *J Am Chem Soc* 2004; 126: 2674–2675. DOI: 10.1021/ja0318030
- [39] Kim S, Kim HJ, Jeon NL. *Integr Biol.* 2010; 2: 584–603. DOI: 10.1039/c0ib00055h
- [40] Abhyankar VV, Lokuta MA, Huttenlocher A, Beebe DJ. *Lab Chip.* 2006; 6: 389–393. DOI: 10.1039/b514133h
- [41] Kricka LJ, Fortina P. *Clin Chem.* 2001; 47: 1479–1482.
- [42] Wang L, Li PCH. *Anal Chim Acta.* 2011; 687: 12–27. DOI: 10.1016/j.aca.2010.11.056
- [43] Liu RH, Dill K, Fuji HS, McShea A. *Expert Rev Mol Diagn.* 2006; 6: 253–261.
- [44] Sosnowski RG, Tu E, Butler WF, OConnell JP, Heller MJ. *Proc Natl Acad Sci USA.* 1997; 94: 1119–1123.
- [45] Lee HH, Smoot J, McMurray Z, Stahl DA, Yager P. *Lab Chip.* 2006; 6: 1163–1170. DOI: 10.1039/B605507A
- [46] Zheng B, Tice JD, Roach LS, Ismagilov RF. *Angew Chem Int Ed Engl.* 2004; 43: 2508–2511. DOI: 10.1002/anie.200453974
- [47] Zhang B, Tice JDm, Ismagilov RF. *Anal Chem.* 2004; 76: 4977–4982. DOI: 10.1021/ac0495743
- [48] Huang S, Li C, Lin B, Qin J. *Lab Chip.* 2010; 10: 2925–2293. DOI: 10.1039/c005227b
- [49] Yager P, Edwards T, Fu E, Helton K, Nelson K, Tam MR, Weigl BH. *Nature.* 2006; 442. DOI: 10.1038/nature05064
- [50] Harrison RG, Greenman MJ, Mall FP, Jackson CM. *Anat Rec.* 2005; 1: 116–128. DOI: 10.1002/ar.1090010503
- [51] Bhise N, Gray RC, Sunshine JC, Htet S, Ewald AJ, Green JJ. *Biomaterials.* 2010; 31: 8088–8096. DOI: 10.1016/j.biomaterials.2010.07.023
- [52] Wang Z, Samanipour R, Koo K, Kim K. *Sens Mater.* 2015; 27: 487–506.
- [53] Breslin S, O'Driscoll L. *Drug Discov Today.* 2013; 18: 240–249. DOI:10.1016/j.drudis.2012.10.003

- [54] Huh D, Hamilton GA, Ingber DE. *Trends Cell Biol.* 2011; 21: 745–754. DOI:10.1016/j.tcb.2011.09.005
- [55] Vaheri A, Enzerink A, Räsänen K, Salmenperä P. *Exp Cell Res.* 2009; 315: 1633–1638. DOI:10.1016/j.yexcr.2009.03.005
- [56] Eiraku M, Watanabe K, Matsuo-Takasaki M, Kawada M, Yonemura S, Matsumura M, Wataya T, Nishiyama A, Muguruma K, Sasai Y. *Cell Stem Cell.* 2008; 3: 519–532. DOI: 10.1016/j.stem.2008.09.002
- [57] Sutherland RM. *J Natl Cancer Inst.* 1971; 46: 113–120. DOI: 10.1093/jnci/46.1
- [58] Yuhas JM, Li AP, Martinez AO, Ladman AJ. *Cancer Res.* 1977; 37: 3639–3643.
- [59] Matsuda N, Shimizu T, Yamato M, Okano T. *Adv Mater.* 2007; 19: 3089–3099. DOI: 10.1002/adma.200701978
- [60] Kawaguchi N, Hatta K, Nakanishi T. *Biomed Res Int.* 2013; 2013: 895967. DOI: 10.1155/2013/895967
- [61] Slamon DJ, Godolphin W, Jones LA, Holt JA, Wong SG, Keith DE, Levin WJ, Stuart SG, Udove J, Ullrich A. *Science.* 1989; 244: 707–712.
- [62] Choi SH, Kim YH, Hebisch M, Sliwinski C, Lee S, D'Avanzo C, Chen H, Hooli B, Asselin C, Muffat J, Klee JB, Zhang C, Wainger BJ, Peitz M, Kovacs DM, Woolf CJ, Wagner SL, Tanzi RE, Kim DY. *Nature.* 2014; 515: 274–281. DOI: 10.1038/nature13800
- [63] Pickl M, Ries CH. *Oncogene.* 2009; 28: 461–468. DOI: 10.1038/onc.2008.394
- [64] Tung YC, Hsiao AY, Allen SG, Torisawa YS, Ho M, Takayama S. *Analyst.* 2011; 136: 473–478. DOI: 10.1039/c0an00609b
- [65] Debnath J, Brugge JS. *Nat Rev Cancer.* 2005; 5: 675–688. DOI:10.1038/nrc1695
- [66] Bhatia SN, Ingber DE. *Nat Biotechnol.* 2014; 32: 760–772. DOI: 10.1038/nbt.2989.
- [67] Kim HJ, Huh D, Hamilton G, Ingber DE. *Lab Chip.* 2012; 12: 2165–2174. DOI: 10.1039/C2LC40074J
- [68] Kim HJ, Ingber DE. Gut-on-a-Chip microenvironment induces human intestinal cells to undergo villus differentiation. *Integr Biol (Camb).* 2013; 5: 1130–1140. DOI: 10.1039/c3ib40126j
- [69] Huh D, Matthews BD, Mammoto A, Montoya-Zavala M, Hsin HY, Ingber DE. *Science.* 2010; 328: 1662–1668. DOI: 10.1126/science.1188302
- [70] Jang K, Suh KY. *Lab Chip.* 2010; 10: 36–42. DOI: 10.1039/B907515A
- [71] Ma Z, Wang J, Loskill P, Huebsch N, Koo S, Svedlund FL, Marks NC, Hua EW, Grigoropoulos CP, Conklin BR, Healy KE. *Nat Commun.* 2015; 14: 7413. DOI: 10.1038/ncomms8413

- [72] Sticker D, Rothbauer M, Lechner S, Hehenberger MT, Ertl P. *Lab Chip*. 2015 Dec 21; 15(24): 4542–4554. DOI: 10.1039/c5lc01028d
- [73] Lee PJ, Hung PJ, Lee LP. *Biotechnol Bioeng*. 2007; 97: 1340–1346. DOI: 10.1002/bit.21360
- [74] Esch MP, Sung JH, Yang J, Yu C, Yu J, March JC, Shuler ML. *Biomed Microdevices*. 2012; 14: 895–906. DOI: 10.1007/s10544-012-9669-0
- [75] You L, Temiyasathit S, Lee P, Kim CH, Tummala P, Yao W, Kingery W, Malone AM, Kwon RY, Jacobs CR. *Bone*. 2008; 42: 172–179. DOI: 10.1016/j.bone.2007.09.047
- [76] Sudo R, Chung S, Zervantonakis IK, Vickerman V, Toshimitsu Y, Griffith LG, Kamm RD. *FASEB J*. 2009; 23: 2155–2164. DOI: 10.1096/fj.08-122820
- [77] Park J, Koito H, Li J, Han A. *Biomed Microdevices*. 2009; 11: 1145–1153. DOI: 10.1007/s10544-009-9331-7
- [78] Halldorsson S, Lucumi E, Gómez-Sjöberg R, Fleming RMT. *Biosens Bioelectron*. 2015; 63: 218–231. DOI: 10.1016/j.bios.2014.07.029
- [79] Jiang S, Cheng R, Wang X, Xue T, Liu Y, Nel A, Huang Y, Duan X. *Nat Comm*. 2013; 2225. DOI: 10.1038/ncomms3225
- [80] Pereira-Rodrigues N, Poleni P-E, Guimard D, Arakawa Y, Sakai Y, Fujii T. *PLoS ONE*. 2010; 5: e9667. DOI: 10.1371/journal.pone.0009667
- [81] Xu H, Ferreira MM, Heilshorn SC. *Lab Chip*. 2014; 14: 2047–2056. DOI: 10.1039/c4lc00162a
- [82] Zeng F, Fu F, Cheng Y, Wang C, Zao Y, Gu Z. *Small*. 2016. DOI: 10.1002/smll.201503208
- [83] Verpoorte E, Oomen P, Skolimowski M, Mulder P, van Midwoud P, Starokozhko V, Merema M, Molema G, Groothuis G. *IEEE*. 2015; 224–227.
- [84] Yum K, Hong SG, Healy KE, Lee LP. *Biotechnol J*. 2014; 9: 16–27. DOI: 10.1002/biot.201300187
- [85] Czupalla CJ, Liebner S, Devraj K. *Methods Mol Biol*. 2014; 1135: 415–437. DOI: 10.1007/978-1-4939-0320-7_34
- [86] Hatherell K, Couraud PO, Romero IA, Weksler B, Pilkington GJ. *J Neurosci Methods*. 2011; 199: 223–229. DOI: 10.1016/j.jneumeth.2011.05.012
- [87] Jang KJ, Cho HS, Bae WG, Kwon TH, Suh KY. *Integr Biol*. 2011; 3: 134–141. DOI: 10.1039/C0IB00018C
- [88] Huh D, Fujioka H, Tung TH, Futai N, Paine R, Grotberg JB, Takayama S. *Proc Natl Acad Sci USA*. 2007; 104: 18886–18891. DOI: 10.1073/pnas.0610868104
- [89] Tavana H, Zamankhan P, Christensen PJ, Grotberg JB, Takayama S. *Biomed Microdevices*. 2011; 13: 31–742. DOI: 10.1007/s10544-011-9543-5

- [90] Douville NJ, Zamankhan P, Tung YC, Li R, Vaughan BL, Tai CF, White J, Christensen P, Grotberg JB, Takayama S. *Lab Chip*. 2011; 11: 609–619. DOI: 10.1039/C0LC00251H
- [91] Schetz M, Dasta J, Goldstein S, Golper T. *Curr Opin Crit Care*. 2005; 11: 555–565.
- [92] Weinberg E, Kaazempur-Mofrad M, Borenstein J. *Int J Artif Organs*. 2008; 31: 508–514.
- [93] Jang KJ, Suh KY. *Lab Chip*. 2010; 10: 36–42. DOI: 10.1039/b907515a
- [94] Jang KJ, Mehr AP, Hamilton GA, McPartlin LA, Chung S, Suh KY, Ingber DE. *Integr Biol (Camb)*. 2013; 5: 1119–1129. DOI: 10.1039/C3IB40049B
- [95] Benson K, Cramer S, Galla H. *CNS*. 2013; 10: 5. DOI: 10.1186/2045-8118-10-5
- [96] Ma SH, Lepak LA, Hussain RJ, Shain W, Shuler ML. *Lab Chip*. 2005; 5: 74–85. DOI: 10.1039/B405713A
- [97] Shayan G, Choi YS, Shusta EV, Shuler ML, Lee KH. *Eur J Pharm Sci*. 2011; 42: 148. DOI: 10.1016/j.ejps.2010.11.005
- [98] Brown JA, Pensabene V, Markov DA, Allwardt V, Neely MD, Shi M, Britt CM, Hoilett OS, Yang Q, Brewer BM. *Biomicrofluidics*. 2015; 9: 054124. DOI: 10.1063/1.4934713
- [99] Booth R, Kim H. *Lab Chip*. 2012; 12: 1784–1792. DOI: 10.1039/c2lc40094d
- [100] Agarwal A, Farouz Y, Nesmith AP, Deravi LF, McCain ML, Parker KK. *Adv Funct Mater*. 2013; 23: 3738–3746. DOI: 10.1002/adfm.201203319
- [101] Grosberg A, Nesmith AP, Goss JA, Brigham MD, McCain ML, Parker KK. *J Pharmacol Toxicol Methods*. 2012; 65: 126–135. DOI: 10.1016/j.vascn.2012.04.001.
- [102] Agarwal A, Goss JA, Cho A, McCain ML, Parker KK. *Lab Chip*. 2013; 13: 3599–3608. DOI: 10.1039/C3LC50350J
- [103] Mathur A, Loskill P, Shao K, Huebsch N, Hong S, Marcus SG, Marks N, Mandegar M, Conklin BR, Lee LP. *Sci Rep*. 2015; 5: 8883. DOI: 10.1038/srep08883
- [104] Jastrzebska E, Tomecka E, Jesion I. *Biosens Bioelectron*. 2016; 75: 67–81. DOI: org/10.1016/j.bios.2015.08.012
- [105] Wang LS, Chung JE, Chan PPY, Kurisawa M. *Biomaterials*. 2010; 31: 1148–1157. DOI: 10.1016/j.biomaterials.2009.10.042
- [106] Organ on chip meeting report. *Lab Chip*. 2013; DOI: 10.1039/c3lc50248a
- [107] Herricks T, Seydel KB, Molyneux M, Taylor T, Rathod PK. *Cell Microbiol*. 2012; 14: 1880–1891. DOI: 10.1111/cmi.12007
- [108] Rigat-Brugarolas L, Elizalde-Torrent A, Bernabeu M, Niz MD, Jaular LM, Fernandez-Becerra C, Homs-Corbera A, Samitier J, del Portillo H. *Lab Chip*. 2014; 14: 1715–1724. DOI: 10.1039/C3LC51449H

- [109] Maron BJ, Wolfson JK, Epstein SE, Roberts WC. *J Am Coll Cardiol.* 1986; 8: 545–557. DOI:10.1016/S0735-1097(86)80181-4
- [110] Günther A, Yasotharan S, Vagaon A, Lochovsky C, Pinto S, Yang J, Lau C, Bolz JV, Bolz SS. *Lab Chip.* 2010; 10: 2341–2349. DOI: 10.1039/C004675B
- [111] Zheng W, Ziang B, Wang D, Zhang W, Wang Z, X Ziang. *Lab Chip.* 2012; 12: 344–3450. DOI: 10.1039/c2lc40173h
- [112] Geerts A. *Semin Liver Dis.* 2001; 21; 311–335. DOI: 10.1055/s-2001-17550
- [113] Kane BJ, Zinner MJ, Yarmush ML, Toner M. *Anal Chem.* 2006; 78: 4291–4298. DOI: 10.1021/ac051856v
- [114] Du C, Narayanan K, Leong MF, Wan AC. *Biomaterials.* 2014; 35: 6006–6014. DOI: 10.1016/j.biomaterials.2014.04.011
- [115] Khetani SR, Bhatia SN. *Nat Biotechnol.* 2008; 26: 120–126. DOI: 10.1038/nbt1361
- [116] Ho CT, Lin EZ, Chen RJ, Chin CK, Gong SE, Chang HY, Peng HL, Hsu L, Yew TR, Chang SF. *Lab Chip.* 2013; 13: 3578–3588. DOI: 10.1039/c3lc50402f
- [117] Feng ZQ, Chu XH, Huang NP, Leach MK, Wang G, Wang YC, Ding YT, Gu ZZ. *Biomaterials.* 2010; 31: 3604–3612. DOI: 10.1016/j.biomaterials.2010.01.080
- [118] Wong SF, Choi YY, Kim DS, Chung BG, Lee SH. *Biomaterials.* 2011; 32: 8087–8096. DOI: 10.1016/j.biomaterials.2011.07.028
- [119] Lee SA, No DY, Kang E, Ju J, Kim DS, SH Lee. *Lab Chip.* 2013; 13: 3529–3537. DOI: 10.1039/C3LC50197C
- [120] Goral VN, Hsieh YC, Petzold ON, Clark JS, Yuen PK, Faris RA. *Lab Chip.* 2010; 10: 3380–3386. DOI: 10.1039/C0LC00135J
- [121] Prodanov L, Jindal R, Bale SS, Hegde M, McCarty WJ, Golberg I, Bhushan A, Yarmush ML, Usta OB. *Biotechnol Bioeng.* 2015; 113: 241–246. DOI: 10.1002/bit.25700
- [122] Domansky K, Inman W, Serdy J, Dash A, Lim MH, Griffith JG. *Lab Chip.* 2010; 10: 51–58. DOI: 10.1039/B913221J
- [123] Lee J, Kim SH, Kim YC, Choi I, Sung JH. *Enzyme Microb Technol.* 2013; 53: 159–164. DOI: 10.1016/j.enzmictec.2013.02.015
- [124] Ma C, Zhao L, Zhou E, Xu J, Shen S, Wang J. *Anal Chem.* 2016; 88: 1719–1727. DOI: 10.1021/acs.analchem.5b03869
- [125] Taylor AM, Blurton-Jones M, Rhee SW, Cribbs DH, Cotman CW, Jeon NL. *Nat Methods.* 2005; 2: 599–605.
- [126] Millet LJ, Gillette MU. *Trends Neurosci.* 2012; 35: 752–776. DOI: 10.1016/j.tins.2012.09.001

- [127] Park J, Lee BK, Jeong GS, Hyun JK, Leeae CJ, Lee SH. *Lab Chip*. 2015; 15: 141–150. DOI: 10.1039/C4LC00962B
- [128] Peyrin JM, Deleglise B, Saias L, Vignes M, Gougis P, Magnifico S, Betuing S, Pietri M, Caboche J, Vanhoutte P. *Lab Chip*. 2011; 11: 3663–3673. DOI: 10.1039/C1LC20014C
- [129] Negishi MK, Morimoto Y, Onoe H, Takeuchi S. *Adv Healthc Mater*. 2013; 2: 1564–1570. DOI: 10.1002/adhm.201370058
- [130] Kunze A, Giugliano M, Valero A, Renaud P. *Biomaterials*. 2011; 32: 2088–2098. DOI: 10.1016/j.biomaterials.2010.11.047
- [131] Jeong GN. *Tissue Eng Regen Med*. 2014; 11: 297–303. DOI: 10.1007/s13770-014-4047-z
- [132] Jeong GS, Chang JY, Park JS, Lee SA, Park D, Woo J, An H, Lee CJ, Lee SH. *Mol Brain*. 2015; 8: 17. DOI: 10.1186/s13041-015-0109-y
- [133] Grafton MMG, Wang L, Vidi PA, Leary J, Lelievre SA. *Integr Biol*. 2011; 3: 451–459. DOI: 10.1039/c0ib00132e
- [134] Swain LE, Smith GD. *Hum Reprod Updat*. 2011; 17: 541–557. DOI: 10.1093/humupd/dmr006
- [135] Smith GD, Rocha AM. *Semin Reprod Med*. 2012; 30: 214–221. DOI: 10.1055/s-0032-1311523
- [136] Quinn P. *Culture Media, Solutions, and Systems in Human ART*, Cambridge University Press, India, 2014
- [137] Isachenko V, Montag M, Isachenko E, van der Ven K, Dorn C, Roesing B. *Reprod Biomed Online*. 2006; 13: 228–234.
- [138] Fukui Y, Lee ES, Araki N. *J Anim Sci*. 1996; 74: 2752–2758. DOI: /1996.74112752x
- [139] Hur Y, Park J, Ryu E, Park S, Lee J, Lee S. *J Assist Reprod Gen*. 2013; 30: 835–84. DOI: 10.1007/s10815-013-0007-0
- [140] Chang KW, Chang PY, Huang HY, Li CJ, Tien CH, Yao DJ, Fan SK, Hsu W, Liu CH. *Sensor Actuator B*. 2016; 226: 218–226. DOI: org/10.1016/j.snb.2015.11.004
- [141] Maschmeyer I, Lorenz AK, Schimek K, Hasenberg T, Ramme AP, Hübner J, Lindner M, Drewell C, Bauer S, Thomas A, Sambo NS, Sonntag F, Laustera R, Marxab U. *Lab Chip*. 2015; 15: 2688–2699. DOI: 10.1039/C5LC00392J
- [142] Maschmeyer I, Lorenz A, Ramme A, Hasenberg T, Schimek K, Hubner J, Lauster R, Marx U. *Abstr-Toxicol Lett*. 2015; 238S: S56–S383. DOI: 10.1016/j.toxlet.2015.08.277
- [143] Scannell JW, Blanckley A, Boldon H, Warrington B. *Nat Rev Drug Discov*. 2012; 11: 191–200. DOI: 10.1038/nrd3681
- [144] Greek R, Menache A. *Int J Med Sci*. 2013; 1: 206–221. DOI: 10.7150/ijms.5529

- [145] Esch MB, Mahler GJ, Stokol T, Shuler ML. *Lab Chip*. 2014; 14: 3081–3092. DOI: 10.1039/C4LC00371C
- [146] Song JW, Cavnar SP, Walker AC, Luker KE, Gupta M, Tung YC, Luker GD, Takayama S. *PLoS ONE*. 2009; 4: e5756. DOI: [org/10.1371/journal.pone.0005756](http://dx.doi.org/10.1371/journal.pone.0005756)
- [147] Kunze A, Lengacher S, Dirren E, Aebischer P, Magistretti PJ, Renaud P. *Integr Biol (Camb)*. 2013; 5: 964–975. DOI: 10.1039/c3ib40022k
- [148] Wang G, et al. *Nat Med*. 2014; 20: 616–623. DOI: 10.1038/nm.3545
- [149] Huh D, Leslie DC, Matthews BD, Fraser JP, Jurek S, Hamilton GA, Thorneloe KS, McAlexander MA, Ingber DE. *Sci Transl Med*. 2012; 4: 159ra147. DOI: 10.1126/scitranslmed.3004249
- [150] Choucha-Snouber L, Aninat C, Grsicom L, Madalinski G, Brochot C, Poleni PE, et al. *Biotechnol Bioengin*. 2012; 110: 597–608. DOI: 10.1002/bit.24707
- [151] Sung JL, Kam C, Shuler ML. *Lab Chip*. 2010; 10: 446–455. DOI: 10.1039/B917763A
- [152] Snouber LC, Bunescu A, Naudot M, Legallais C, Brochot C, Dumas ME, Herrmann BE, Leclerc E. *Toxicol Sci*. 2013; 132: 8–20. DOI:10.1093/toxsci/kfs230
- [153] Aref AR, Huang RY, Yu W, Chua KN, Sun W, Tu TY, Bai J, Sim WJ, Zervantonakis IK, Thiery JP, Kamm RD. *Integr Biol (Camb)*. 2013; 5: 381–389. DOI: 10.1039/c2ib20209c
- [154] Imura Y, Sato K, Yoshimura E. *Anal Chem*. 2010; 82: 9983–9988. DOI: 10.1021/ac100806x
- [155] Sung JH, Shuler ML. *Lab Chip*. 2009; 9: 1385–1394. DOI: 10.1039/B901377F
- [156] Mathur A, Loskill P, Hong S, Lee J, Marcus SG, Dumont L, Conklin BR, Willenbring H, Lee LP, Healy KE. *Stem Cell Res Ther*. 2013; 4 Suppl 1: S14. DOI: 10.1186/scrt375
- [157] Sutherland ML, Fabre KM, Tagle DA. *Stem Cell Res Ther*. 2013; 4 (Suppl. 1): I1. DOI: 10.1186/scrt361
- [158] Bernard A, Reanult JP, Michel HR, Bosshard HR, Delamarche E. *Adv Mat*. 2000; 12: 1067. DOI: 10.1002/1521-4095(200007)12:14<1067::AID-ADMA1067>3.0.CO;2-M
- [159] Therriault D, White SR, Lewis JA. *Nat Mat*. 2; 2003: 265–271. DOI:10.1038/nmat863

