

---

# Current Developments in Thermochemical Conversion of Biomass to Fuels and Chemicals

---

Chan Seung Park, Partho Sarothi Roy and  
Su Hyun Kim

Additional information is available at the end of the chapter

<http://dx.doi.org/10.5772/intechopen.71464>

---

## Abstract

Biomass is one of the largest concentrated carbon source available for producing renewable energy. Thermochemical conversion of biomass has been used for centuries in various settings. Biomass typically has a higher oxygen and volatile matter content than other solid carbon feedstocks, resulting in increased reactivity during conversion by thermochemical pathways. Moisture content of the biomass feedstock exerts significant influence on the conversion process and is an important criteria used to classify various thermochemical conversion technologies. This chapter discusses the current status and future outlook of thermochemical biomass conversion processes.

**Keywords:** biomass, gasification, pyrolysis, hydrothermal treatment, steam hydrogasification, combustion

---

## 1. Introduction

Biomass has always considered as one of the major energy source for the world. Biomass can be defined as plant materials and animal waste, although broader definitions that include other forms of carbonaceous waste are used in the renewable energy context. Earth's primary source of biomass is the plant matter that grows through photosynthesis. The carbon stored in the biomass is from the carbon dioxide consumed during photosynthesis and is ultimately converted back to carbon dioxide during any energy generation processes. As is well known, biomass based processes are often carbon neutral, i.e., do not add additional carbon dioxide to the atmosphere, or have a very low carbon footprint. For these reasons, biomass is the largest and most widespread carbon source for producing renewable energy and is relatively free of fluctuation problems inherent to wind and solar energy. A comprehensive inventory of biomass

---

resources in the United States potentially available for energy production is available as so-called “billion-ton study” by the U.S. Department of Energy [1].

The oldest energy conversion process used by humans is biomass combustion in open air to produce heat. Biomass burning is still a dominant process in many parts of the world and thermochemical conversion of biomass to energy has a long scientific history. Since then, various thermochemical processes for biomass conversion have been developed to overcome the primary limitation of combustion; it only produces thermal energy along with the flue gases. Thermochemical biomass conversion to gaseous and liquid fuels has been studied and practiced for centuries. Production of a number of chemical compounds from biomass is also important application of the thermochemical process. The first such example is charcoal production from wood around 4000 B.C.

Compared to coal, which is the most widely used conventional solid fuel for energy production, biomass typically contains a higher oxygen and volatile matter content and lower ash [2]. This high oxygen content makes biomass a good fuel although oxygen itself does not contribute toward the energy value of the fuel. The higher oxygen content results in reduced air (oxygen) requirement during the combustion reaction. **Table 1** summarizes the Lower Heating Value (LHV) of different fuels. Coal has a higher LHV than biomass per unit mass of the fuel. However, once the volume of air required for complete combustion is taken into account (LHV per mass per air mix), biomass’s value is higher than that of coal, and is even comparable to methane.

Nearly 80% of the carbon in the biomass is typically considered “organic,” i.e., bounded to hydrogen or oxygen. Organic carbon is highly volatile compared to elementary carbon, resulting in improved reactivity and thus makes biomass an attractive feedstock for thermochemical production of fuels and chemicals, especially from the conversion perspective. **Table 2** summarizes the typical oxygen and volatile content of coal and biomass. Conversion of the volatile portion of the biomass feedstock into gaseous species starts around 225 to 300°C and is mostly complete around 500 to 600°C [4]. While elemental, non-volatile carbon decompose at temperatures above 800°C, much higher temperatures (>1200°C) are desirable to avoid potential problems associated with ash softening [5]. Thus, thermochemical conversion of biomass can be performed at the much lower temperatures than is needed for coal, with higher conversion efficiency.

LHV	Methane	Bituminous coal	Biomass	Hydrogen
MJ/kg fuel [3]	47	27	18	120
MJ/kg fuel/air mix	2.62	2.44	2.60	3.36

**Table 1.** Comparison of LHV values of methane, coal, biomass and hydrogen.

Components	Bituminous coal	Biomass
Oxygen (wt.%, dry ash free, daf)	14	43
Volatiles (wt.%, daf)	42	82

**Table 2.** Oxygen and volatiles content of coal and biomass.

From the thermodynamic point of view, at the typical biomass conversion temperature of 800°C, the product gas typically has higher concentrations of more valuable C<sub>2+</sub> species. **Table 3** shows product gas composition of a biomass gasifier operated by the Milena project [6], a well-known biomass gasification demonstration project in Europe, along with the gas composition of a typical coal gasifier operated at higher temperatures (1400°C), which more closely represents the thermodynamic equilibrium values.

It also shows the product gas has lower syngas ratio (syngas or synthesis gas is a mixture of hydrogen and carbon monoxide and syngas ratio is the molar ratio of Hydrogen to CO), which typically provides more flexibility during use in downstream processes that require specific syngas ratios. Syngas ratio can be increased using the well-known, commercially matured, water-gas shift process. Syngas ratio reduction is achieved through techniques such as membrane separation, and presents a number of technical challenges [7]. Higher CH<sub>4</sub> content is also beneficial since the product gas is often used as a fuel in combustion engines or boilers. C<sub>2+</sub>, i.e., gaseous carbon species with a higher carbon number, can potentially be used as a feedstock in chemical production. Such high value co-products often provide an additional revenue stream, improving the overall economics of the biomass gasification plant.

In conclusion, biomass is the only concentrated renewable carbon source that can be converted into fuels and chemicals with a zero or very low carbon footprint. Unlike biological processes that only convert part of the biomass, thermochemical processes can generally convert all the carbon in the feedstock. Biomass is a reactive, desirable feedstock for thermochemical processes due to the higher oxygen content compared to coal. Thermochemical conversion of biomass offers significant versatility since the product gas can be converted into fungible liquid fuels, thereby offering a pathway to reduce the carbon intensity of the transportation sector. The product gas from most thermochemical processes can also be converted into high value chemicals such as ethylene and BTX (Benzene, Toluene, and Xylene).

Some thermochemical process such as flash pyrolysis and hydrothermal liquefaction directly produce a liquid product. Thermochemical processes can also handle intermediate products and waste biomass from biological conversion processes [8]. High value chemicals production from biomass with energy as a major co-product may be the path to economic viability in the near future.

This chapter presents an overview of the different thermochemical processes that convert biomass into a high energy content gaseous or liquid product and/or additional thermal energy. A discussion of the unique aspects of different technologies from various perspectives, including energy storage and transportation is also provided.

Mole fraction, %	H <sub>2</sub>	CO	CO <sub>2</sub>	CH <sub>4</sub>	C <sub>2+</sub>
Equilibrium value	51	45	3	1	0
Measured (Milena FB gasifier) [6]	25	33	18	15	6

**Table 3.** Comparison of product gas composition under equilibrium conditions with those from a biomass gasifier.

## 2. Classification of thermochemical biomass conversion processes

Biomass is the only renewable resource that can be directly converted in to concentrated energy products using thermochemical conversion [9]. Biomass consists of organic and inorganic matter and often significant amounts of moisture. Organic matter in biomass contributes to its calorific value. Organic matter can be further classified into cellulose, hemicellulose, and lignin. The inorganic matter is conventionally referred to as ash. Compared to conventional fuels, the oxygen content of biomass is typically very high, approximately ranging from 20 to 50% by weight. The moisture content plays a very important role in selecting the appropriate thermochemical conversion process. Heating value of biomass is heavily dependent on the moisture content. The LHV value is negative for biomass with a high moisture content (80%), since the heat released during the combustion process is not sufficient to evaporate all the water [10]. Therefore, biomass is usually dried under sunlight or through other methods, e.g., using recycled thermal energy as part of feed preparation. Solar and air drying in the production field is the preferred method of drying, primarily due to the lower cost. However, there are several conversion routes that use wet biomass feedstocks without the need for drying. Whether a conversion process uses wet or dry biomass as the feedstock is an important criteria for the classification of biomass conversion processes. A technology is categorized as a wet biomass process based on whether the moisture in the feedstock plays an important role in the process, either as a major reactant, or as physical media to maintain the reaction environment. In other words, wet biomass processes do not benefit from drying the feedstock, and often require the feedstock to contain certain quantity of moisture. **Table 4** lists the wet and dry biomass feedstock processes, and these processes are discussed in detail in the rest of the chapter.

Feedstock	Technology	Features
Wet biomass	Biological*	Anaerobic digestion, or alcohol production from sugars by biomass hydrolysis and fermentation
	Hydrothermal conversion	High pressure conversion to a hydrophobic oil. Often involves further catalytic conversion to methane, liquid fuels or chemicals
	Supercritical gasification	Conversion occurs under supercritical conditions
	Steam hydrogasification	Uses hydrogen and steam as the gasifying agents
Dry biomass	Oil extraction form seeds*	Trans-esterification or hydrogenation of vegetable oil from oil seeds to produce bio-diesel
	Direct combustion	Generate heat or power through the direct combustion of biomass
	Slow pyrolysis	Heating up the biomass in the absence of air (or oxygen) with slow heating rates to produce biochar and gaseous products
	Fast pyrolysis	Extremely fast pyrolysis of biomass with very high heating rates resulting in crude oil like bio-oil and gaseous products
	Gasification	Biomass is converted into the syngas or Substituted Natural Gas (Bio-SNG) using air or oxygen or hydrogen as the gasifying agent

\*These processes are outside the scope of this chapter and are not covered.

**Table 4.** Classification of biomass conversion processes.

Recently, the bio-refinery concept has emerged as an important option. A bio-refinery integrates several conversion and resource recovery processes with the aim of maximizing process efficiency, minimizing waste and improving profits [9]. An integrated bio-refinery may use additional feedstocks besides biomass and will produce multiple products including fuels, chemicals and thermal or electrical energy. The bio-refinery concept is still evolving, and has the potential to be an important biomass utilization option in the future that incorporates a wide range of options including biological and thermochemical processes to overcome the limitations of specific technologies.

### 3. Wet biomass conversion processes

#### 3.1. Hydrothermal conversion process

Hydrothermal conversion has been studied for more than a 100 years. Friedrich Bergius, who would later receive the 1931 Nobel Prize in Chemistry along with Carl Bosch, developed the Bergius process that produces liquid fuel through hydrogenation of crude oil derived from hydrothermal treatment of coal. The technology was also applied to peat and plant material [11]. Hydrothermal conversion converts biomass into “bio-crude” through thermal depolymerisation under high pressures and moderate temperatures and has since then been studied by several research groups. A comprehensive review of the hydrothermal conversion process of the biomass is provided by Peterson et al. [12].

Hydrothermal processes can convert all types of biomass, including wet organic biomass, and typically involves the use of a catalyst to improve conversion efficiency. Hydrothermal liquefaction study conducted by Yang et al., shows that the process produces larger amount of oil product compared to other methods [12]. The product liquid fuel is easy to separate, for once it is cooled down to the room temperature the gaseous product is emitted very quickly [13]. The product bio-crude, can be further processed into high-quality diesel or kerosene. The fast pyrolysis process, discussed later, is a dry conversion process that produces a bio-crude (or bio-oil) from dry biomass feedstock. Hydrothermal conversion process has lower efficiencies caused by the significant energy requirement of water evaporation.

Hydrothermal conversion processes can be further divided into supercritical hydrothermal and subcritical conversion processes. A supercritical hydrothermal conversion process developed by Aalborg University and commercialized by Steeper Energy under the name of “Hydrofraction” converts organic wastes into a raw bio-crude under supercritical conditions in the presence of  $K_2CO_3$  catalyst [14]. Another process, referred to as the “Catliq” process uses Zirconia catalyst under supercritical conditions to produce a bio-crude with less than 6% oxygen content [15].

Shell research group has demonstrated a subcritical process named Hydro Thermal Upgrading (HTU) that converts the biomass into bio-crude with and without a catalyst [16]. Research has shown that in the presence of a catalyst with adequate activity, conversion could be accomplished at conditions that are less severe than supercritical. A number of catalysts including ones based on Ru, Carbon, and Ni have been proposed with the ultimate goal of developing an optimal hydrothermal conversion process under subcritical conditions [17].

### 3.2. Supercritical gasification

The supercritical condition for water is the combination of  $T > 374^{\circ}\text{C}$  and  $P > 218$  atm. Under these conditions, distinct liquid and vapor phases do not exist and the water exists as a single phase fluid [18]. The general reason to use supercritical conditions for wet feedstocks is to minimize the energy loss associated with water evaporation. Study performed by Demirbas [19] and Gadhe, & Gupta [20] shows that the supercritical water behaves as an organic solvent and exhibits extraordinary solubility toward organic compounds containing large nonpolar groups and most permanent gases. Transition of liquid water to the gas phase (steam) requires a large amount of heat, so-called "the heat of vaporization," which can be recovered in theory, but needs very efficient heat exchanger design. By operating the conversion process under supercritical conditions, uniform temperature profile along the reactor can be expected without the formation of multi-phase of water (liquid water, steam and/or superheated steam), which in turn results in efficient heat transfer between the product gas and feed inlet of the gasifier.

Supercritical biomass gasifiers typically operate around 500 to 750°C without a catalyst or at temperatures below 500°C in the presence of a catalyst. The presence of supercritical water leads to rapid hydrolysis of biomass and high solubility of intermediate reaction products including gaseous species. These features make supercritical gasification as excellent tool for the conversion of very wet biomass feedstocks such as aquatic species and sewage sludge (a.k.a. biosolids), which normally require considerable drying before they can be gasified economically. Supercritical gasification also produces a high pressure product gas, thereby eliminating the need for the product gas compression required by most down-stream processes. A detailed discussion of process efficiency and other aspects of supercritical gasification is available in the article by [21]. For example, the gasification efficiency of a biomass feedstock with 80% water content using conventional steam reforming reaction is only 10%, while that of supercritical gasification can be as high as 70%. The main products are  $\text{H}_2$  and  $\text{CO}_2$  and the hydrogen is produced at very high pressure which is at the storage condition and reduces the storage cost. Also, the reactor operates at high reaction temperature, low residence time, and low biomass concentration.

However, there are several technological issues that must be overcome in order for supercritical processes to be commercially viable:

- Supercritical gasification processes need large heat input. Efficient design of heat exchanger is critical to achieve desired energy conversion efficiency.
- The feeding of wet biomass is another barrier, although slurry pump has been used to feed into the high pressure vessel. However, achieving reliable feeding into supercritical gasification reactor under a very high operating pressure is still a significant challenge.
- Other issues such as fouling, plugging of the feedstock, and corrosion are well reviewed by [22].
- Higher capital costs due the high operating pressure also have a negative impact on economic performance.

For these reasons, supercritical gasification processes are still in the development stage [23]. University of Twente operates a pilot plant and is involved in active research and development [24].

The VERENA group operates a somewhat larger pilot plant with 100 kg per hour throughput in Karlsruhe, Germany [25].

### 3.3. Steam hydrogasification

Steam hydrogasification uses steam and hydrogen as the gasifying agents and is especially suited for the conversion of wet feedstocks since it utilizes the water from the feedstock as a major reactant other than the physical media served as a thermal moderator [26]. Hydrogasification, using only hydrogen as the gasifying agent, is a well-known conversion technology but is not considered commercially viable due to several issues, including low conversion efficiencies and requirement of an external hydrogen source [27]. Research has shown that hydrogasification in the presence of steam significantly enhances the rate of methane formation under specific process conditions, thereby improving the overall process efficiency [28, 29]. This process, referred to as “steam hydrogasification,” produces a product gas with a high methane content. The product gas also contains a considerable amount of unreacted steam along with CO, CO<sub>2</sub>, H<sub>2</sub>, and some higher molecular hydrocarbons. The product gas can then be converted into various fuels or chemical products. The impurities in the flue gas is significant during the steam hydrogasification. Cui et al., [30] developed Ni based catalyst and ZnO sorbent for contaminant and sulfur removal from the product gas and they were able to reduce the components significantly.

An example block flow diagram for Renewable Natural Gas (RNG) production is shown in **Figure 1**. The feedstock is turned into a slurry through a hydrothermal pre-treatment process (HTP) and is transported into the steam hydrogasification reactor (SHR) using a slurry pump. A portion of the necessary steam enters the reactor as water that is part of the slurry along with additional superheated steam and recycled hydrogen.

The methane-rich gasifier product gas is then subjected to warm gas clean-up in order to remove contaminants such as sulfur and other species. Following this, the excess steam and CO is converted into hydrogen in a water gas shift reactor (WGS). This is an important aspect of the process: Even though the steam hydrogasification process needs hydrogen, it does not require an external source of hydrogen. The hydrogen is separated and fed back into the gasifier, making the process self-sustained in terms of the hydrogen supply. The process is currently undergoing demonstration [31].

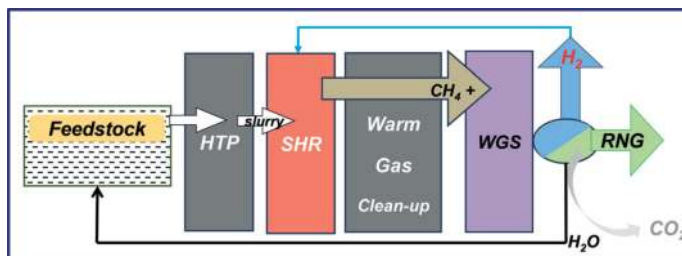

**Figure 1.** Block diagram of RNG production by steam hydrogasification process.

## 4. Dry biomass conversion processes

### 4.1. Gasification

Gasification, which implies incomplete combustion (also commonly referred to as partial oxidation) of the carbonaceous feedstock, is one of the most attractive options to convert biomass into various high value products such as liquid and gaseous fuels, chemicals and electricity. Gasification is the most popular among the thermochemical conversion processes with the exception of direct combustion. Gasification processes have several advantages and disadvantages over other conversion technologies. The main advantages are that the gasification feedstock can be any type of biomass including agricultural residues, forestry residues, by-products from chemical processes, and even organic municipal wastes. Moreover, gasification typically converts the entire carbon content of the feedstock, making it more attractive than enzymatic ethanol production or anaerobic digestion where only portions of the biomass material are converted to fuel. The second advantage is that the product gas can be converted into a variety of fuels ( $H_2$ , Bio-SNG, synthetic diesel and gasoline, etc.) and chemicals (methanol, urea). The other benefit of the biomass gasification process is lowered  $CO_2$  emissions, compact equipment setup with higher thermal efficiency [32]. Thus gasification is most suitable to produce chemicals that can be alternatives to petroleum based products.

Gasification technology for biomass conversion is commercially applied in China: in 1990, China built more than 70 biomass gasification projects for household cooking and each of them can supply energy for 800–1600 families [32] whereas in India, a perspective way of electricity generation is gasification.

Gasification processes are primarily designed to produce synthesis gas (syngas, a mixture of hydrogen and carbon monoxide) by converting the feedstock under reducing (oxygen deficient) conditions in the presence of a limited amount of gasifying agent such as air or oxygen [5]. Gasification consists of three major steps. The first step is devolatilization of the dried feedstock to produce the fuel gas for the second step, which is combustion. The combustion step produces the necessary heat and reducing environment required for the final step. The final step (so-called reduction step, char gasification step or syngas production step), is the slowest reaction phase in gasification, and often governs the overall gasification reaction rate. These 3 steps can be shown as:

Devolatilization: Feedstock  $\rightarrow$  Fuel gas + Char.

Combustion: Fuel gas + Air  $\rightarrow$  Flue gas + Heat ( $\sim 25\%$  of carbon)

Reduction: Fuel gas, Char + Heat  $\rightarrow$  Syngas ( $\sim 75\%$  of carbon)

Gasification: Feedstock + Air  $\rightarrow$  Syngas + Flue gas + Ash.

Approximately 25% of carbon in the feedstock is consumed in the combustion step to provide the heat and reducing environment for the reduction step. A detailed discussion of gasification, including minor steps and considerations is available elsewhere [5].



The dual fluidized bed reactor configuration is a well-known option for the gasification of biomass feedstock. This configuration uses two separate reactors, one for the combustion and the other for the reduction reaction.

Benefits of the dual bed configuration for biomass gasification are [33]:

- Provides improved process efficiencies and avoids the challenges related to ash melting by operating at lower gasification temperatures (normally greater than 800°C but below the ash softening point).
- Other fuel sources can be used for the combustion step to overcome the low heating value of the biomass feedstock. These fuels include char by-product from the reduction reactor or other designated fuels such as methane.
- Air is only used in the combustion reactor and does not enter the reduction reactor, thereby preventing nitrogen dilution of syngas, a major problem in air blown gasifiers [34].

The heat required for the reduction reaction is supplied through the bed material (typically sand) from the combustion reactor. The bed material is continuously circulated between the two reactors while the ash is removed from the bed material using cyclones and the gases from the two reactors are not allowed to mix. The Milena project gasifier uses the two reactor configuration [35].

Tar formation in a gasifier during gasification process is significantly affected by reactor/gasifier configuration. Cao et al. [36] introduced an innovative fluidized bed gasifier which can produce tar free product flue gas. The factors that affects the biomass gasification process most are: the reaction temperature, residence time and oxygen to biomass ratio [37]. According to this study, the optimum residence time is 1.6 s and the optimum oxygen to biomass ratio is 0.4.

A major challenge of biomass gasification is to overcome the higher specific capital and operating costs. This is due to the much smaller plant sizes (normally less than 500 tons per day) compared to coal gasification plants (tens of thousands of tons per day). The plant size is determined by biomass availability and related logistic issues and transportation costs inherent to any distributed resource. Other challenges include the presence of undesirable species such as alkali compounds in biomass ash. Alkali materials such as sodium and potassium cause slagging and fouling problems [38]. Most biomass gasifiers operate below the ash softening temperature to avoid ash melting. The lower temperatures also lead to lower capital cost requirement, resulting in favorable process economics. However, lower temperatures often result in the formation of undesired tar, which leads to severe operational problems. A number of catalysts and process configurations have been developed to address this issue, but tar problems still persist [39]. Addition of a catalytic tar cracker to the outlet of the gasifier to decompose the tars into smaller molecules has been considered [40]. Washing out the tars while the product gas is cooling down has also been proposed, but this approach requires rigorous treatment of the washing water. Tar formation is still a major challenge and is regarded as the "Achilles heel" of biomass gasification processes. These issues are not to be underestimated and careful attention is required in the design and operation of biomass gasifiers.

The study performed by van de Kaa, Kamp and Rezaei [41], investigated the technology dominance of the three different dry thermochemical conversion of biomass. They found that the gasification technology has the highest potential of becoming the commercial technology for biomass conversion in the Netherlands.

## 4.2. Bio-SNG production by gasification

### 4.2.1. Current status of bio-SNG R&D projects

Bio-SNG is a fuel made from syngas produced by biomass gasification with major constituent of natural gas for potential use in household or transportation. Various R&D projects on biomass gasification are underway in many EU nations with specific objectives of enhanced generation and distribution of renewable energy and consequent reduction in greenhouse gas evolution: Current status of 3 Bio-SNG projects in Austria, the Netherlands, and Sweden is introduced.

### 4.2.2. SNG demonstration plant (Austria, Güssing)

- Fluidized bed gasification demonstration plant in operation at Güssing, Austria burning wood chips. Details are summarized in **Figures 2–4** and **Tables 5–7**.

### 4.2.3. ECN SNG project (Netherlands)

- At present, EU is setting legally-binding objectives of 20% CO<sub>2</sub> reduction by 2020 and further 60–80% by 2050 and thus the Netherlands is planning to increase the bio-SNG portion to 20% of primary energy generation source in compliance. Dutch ECN [44] has already performed feasibility study on production of SNG from biomass gasification since 2002 with fluidized bed gasifier consisting of gas purification system, and subsequent methanation and SNG upgrading processes. Details of ECN-initiated bio-SNG plant R&D stages and unit processes are shown in **Figures 5** and **6**.

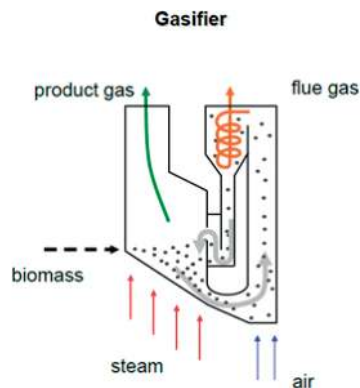

Figure 2. Gasifier type [42].

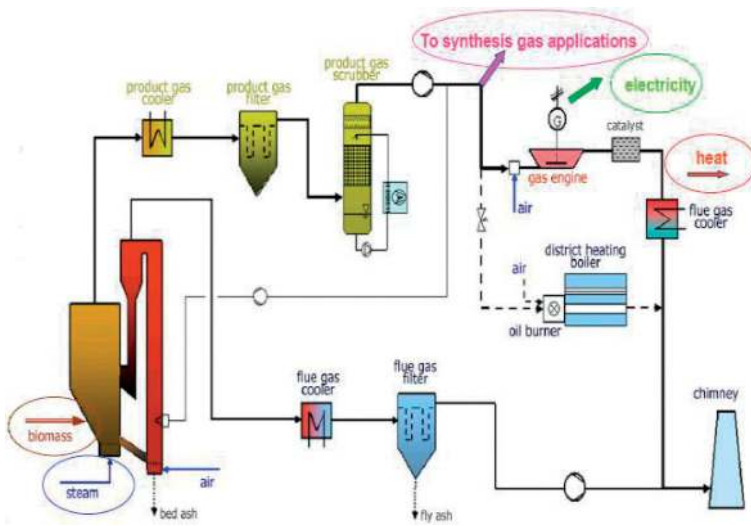

Figure 3. Process flow diagram of the gasification plant [43].



Figure 4. 1 MW capacity SNG demonstration plant [43].

The ECN bio-SNG plant gasifier is named as “MILENA,” with circulating fluidized bed gasifier and bubbling fluidized combustor as main elements proper. The gasifier operates at 800°C, with various feedstocks. Overall gasification performance and processes of the ECN bio-SNG plant are shown in Figure 7 and Table 8.

#### 4.2.4. GoBiGas project (Sweden, Gothenburg)

- Sweden has currently set 50% proportion of renewable energy sources in the national energy generation and concomitant reduction of CO<sub>2</sub> evolution by 40%. Besides, they are planning to exclude reliance on fossil fuel sources in national transport system by 2030. Göteborg Energi initiated relevant R&D by performing feasibility studies on various

Items	Contents
Feedstock	<ul style="list-style-type: none"> <li>• Wood chip(Moisture 20–30%) 2300 kg/h</li> </ul>
Gasifier type	<ul style="list-style-type: none"> <li>• Dual fluidized bed steam gasifier,</li> <li>• two-stage gas cleaning system</li> <li>• gas engine with an electricity generator</li> <li>• heat utilization system</li> </ul>
Capacity	<ul style="list-style-type: none"> <li>• 8 MWth(2MWe)</li> <li>• Commercial bio-SNG plants: announced as 20–200 MW</li> </ul>
Final Product	<ul style="list-style-type: none"> <li>• Currently used as power and heat by operation of gas engine</li> <li>• SNG synthesis is separately studied at Paul-Scherrer Institute, Sweden (1000 h demonstration experiment linked with slip stream</li> <li>• 1 MW demonstration SNG plant construction completed</li> <li>• 8-year of ongoing R&amp;D in gas conditioning and synthesis of SNG</li> </ul>
History	<ul style="list-style-type: none"> <li>• R&amp;D since 2002</li> <li>• 10 M EURO invested (government subsidy of 6 M EURO inclusive)</li> <li>• Plant operation cost per annum at 15% of total investment</li> <li>• Recorded cumulative operation time of more than 60,000 h</li> <li>• R &amp; D Project under name of “GAYA” as of 2010</li> </ul>

**Table 5.** Summary of the project.

Main components (vol %)		
H <sub>2</sub>	%	35–45
CO	%	22–25
CH <sub>4</sub>	%	~10
CO <sub>2</sub>	%	20–25
Minor components		
C <sub>2</sub> H <sub>4</sub>	%	2–3
C <sub>2</sub> H <sub>6</sub>	%	~0.5
C <sub>2</sub> H <sub>2</sub>	%	~0.4
O <sub>2</sub>	%	<0.1
N <sub>2</sub>	%	1–3
C <sub>6</sub> H <sub>6</sub>	g/m <sup>3</sup>	~8
C <sub>7</sub> H <sub>8</sub>	g/m <sup>3</sup>	~0.5
C <sub>10</sub> H <sub>8</sub>	g/m <sup>3</sup>	~2
TARS	mg/m <sup>3</sup>	20–30

**Table 6.** Syngas composition [43].

gasification technologies since 2006 and has completed fundamental engineering design as a result of primary stage progress during 2008–2013, thus enabling construction of a 20 MW bio-SNG demonstration plant. The production capacity of the 20 MW bio-SNG demonstration plant was equivalent to fuel 15,000–20,000 hydrogen fuel cell vehicles, based on the same type of gasifier as that of aforementioned Güssing, Austria. The bio-

Main components		
LHV	MJ/Nm <sup>3</sup>	34.20
CH <sub>4</sub>	%	94.81
CO <sub>2</sub>	%	0.47
H <sub>2</sub>	%	1.55
H <sub>2</sub> O	%	0.16
N <sub>2</sub>	%	2.67

Table 7. Bio-SNG composition [43].

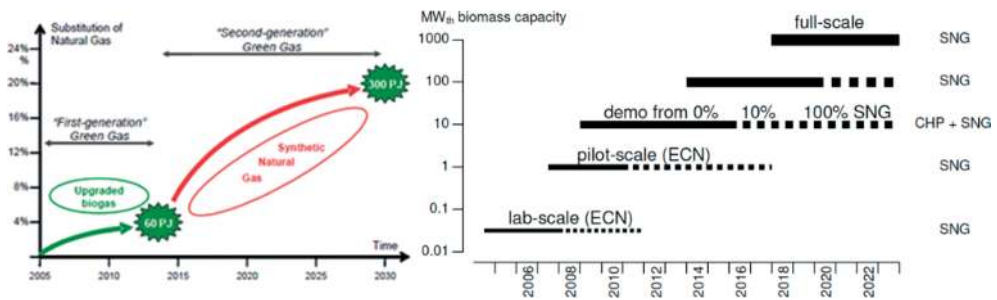

Figure 5. Overall timeline of the Dutch bio-SNG project [44].

SNG demonstration plant already supplied hydrogen fuel via natural gas distribution network with accumulated operation record exceeding 10,000 h. The methane concentration and calorific value of the SNG thus produced were 96.5–97.5% and 10.8 kWh/Nm<sup>3</sup> (HHV basis) which will be used as a basis for construction of a commercial scale gasifier with 80–100 MW capacity after successful operation of the demonstration plant for reliability substantiation. Overall unit processes and their flow diagram are illustrated in Figure 8.

### 4.3. Slow/fast pyrolysis

Pyrolysis is the thermal decomposition of the feedstock in the absence of oxygen. The products of biomass pyrolysis are char, bio-oil (also referred to as bio-crude) and gases including methane, hydrogen, carbon monoxide, and carbon dioxide. Pyrolysis can be further classified into slow and fast pyrolysis based on the residence time of the solid biomass in the reactor. Fast pyrolysis is normally conducted under medium to high temperatures (usually 450–550°C) at very high heating rates and short residence time (e.g., milliseconds to a few seconds).

The objective of the process is to maximize the liquid yield and minimize the production of char and gases. This requires fast heating of the biomass and produces bio-oil (~60% by weight) and other products including gas and char [49]. On the other hand, slow

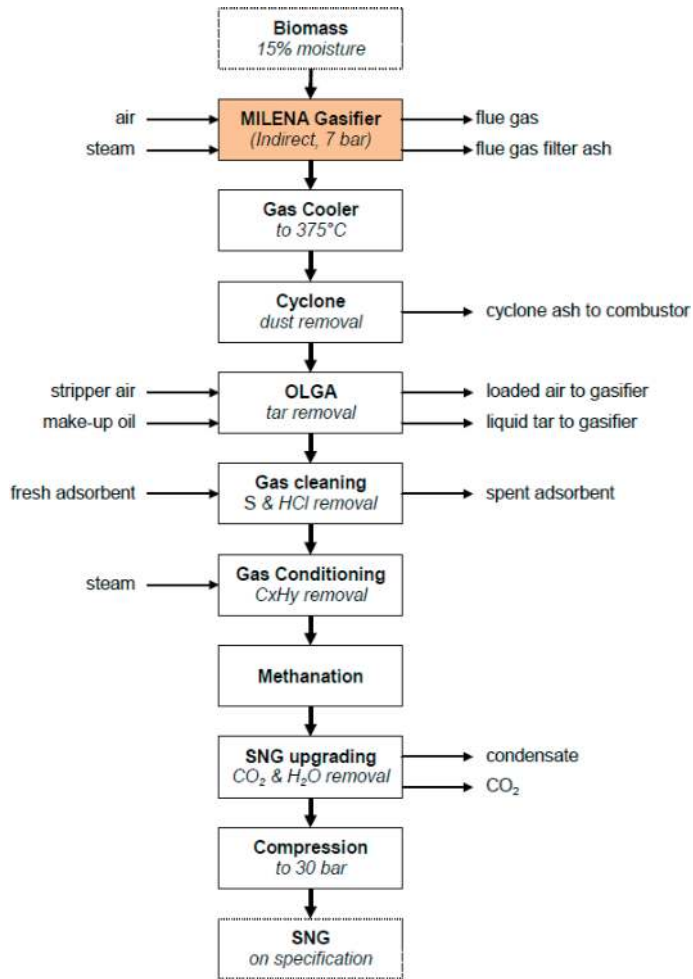

Figure 6. Process step of pilot and demo plants [45].

pyrolysis takes several hours to complete with bio-char being the main product. Pan et al. [50] performed the slow pyrolysis of *Nannochloropsis* sp. (a kind of green microalga) and showed that the catalytic pyrolysis can produce the fuel with low oxygen content and higher heating value than the pyrolysis product without catalyst. Fast pyrolysis has attracted considerable attention in recent years. Fast pyrolysis efficiency, in addition to the residence time and operating temperature, is strongly dependent on the particle size of the feedstock as rapid and efficient heat transfer through the particle is critical. Most fast pyrolysis processes use a maximum particle size of 2 mm. Pyrolysis processes can be built in relatively small scales and are well suited for lignocellulosic feedstocks. Efficient thermal energy input to the reactor is critical since the pyrolysis process is endothermic

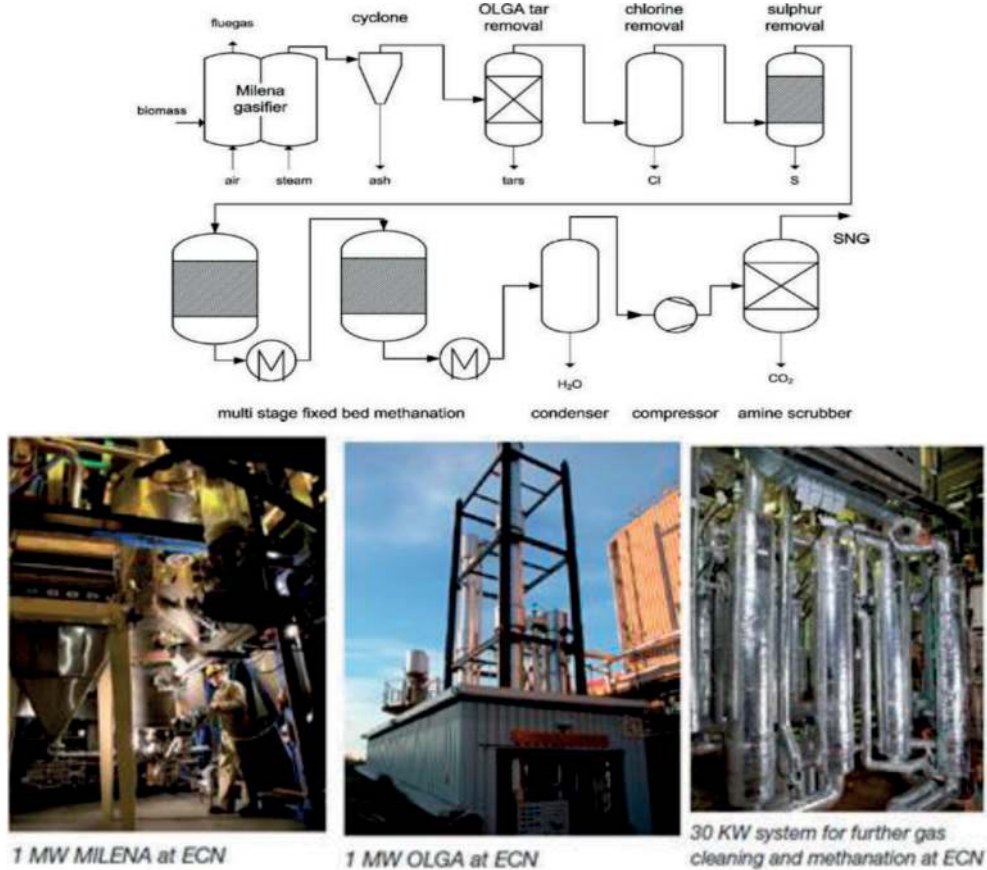

Figure 7. Process flow diagram and unit process of the ECN bio-SNG plant [47].

SNG-process characteristics	Milena
Carbon conversion (%)	80
Biomass-to-SNG efficiency (%)	66.3
Overall process efficiency (%)	82
Gas yield(Nm <sup>3</sup> /kg biomass)	0.82

Table 8. Performance of the ECN bio-SNG plant [46].

and heat transfer rates play a major role in the conversion process. High moisture content biomass must be dried prior to the conversion process. Besides oil and gas, bio-char is an important pyrolysis product. Bio-char is well-known as a soil amendment as it is highly absorbent and increases the soil's ability to retain water and nutrients. This fast process product yields more than 70 wt.% biomass when operates at atmospheric pressure and

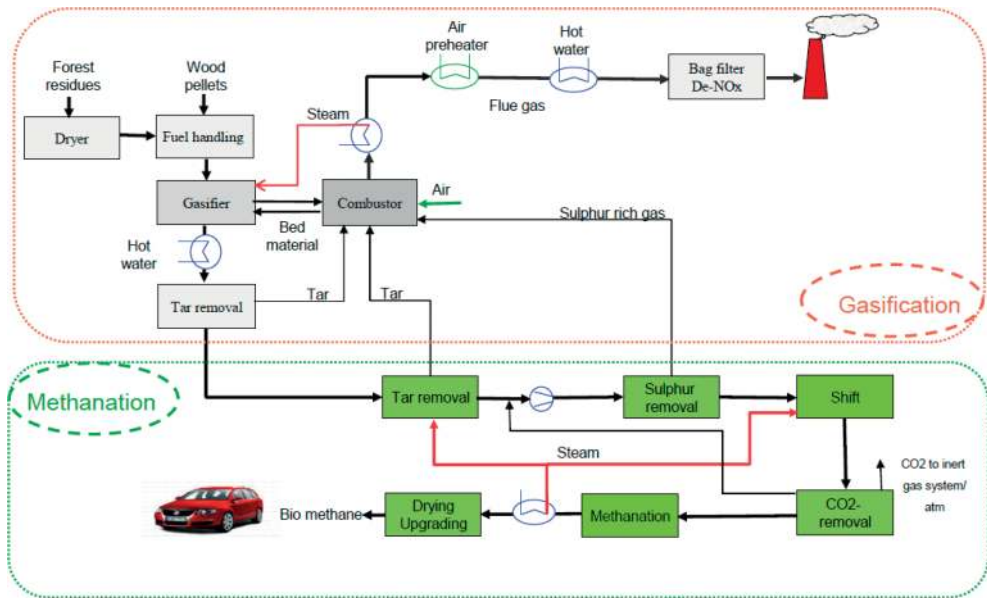

Figure 8. Process diagram of the Swedish GoBiGas plant [48].

moderate temperatures (450°C). Oxygen and water are major by-products during fast pyrolysis and these components degrades the fuel quality to the low-grade fuel compared to conventional hydrocarbon fuel [51].

Duman et al. [52] performed a comparison study of slow and fast pyrolysis: medium level of bio-oil is produced by slow pyrolysis of cherry seeds with only 21 wt.% yields whereas the bio-oil of 44% yield is produced by fast pyrolysis of the same feedstock.

Flash pyrolysis is an emerging technology and there are several key issues that need to be addressed. The most critical problems are associated with the quality of the “bio-oil,” dictated by the physical and the chemical properties. Some of these problems are discussed below. Ideally, bio-oil should be interchangeable with petroleum crude oil so that the transportation and refining infrastructure can be used in existing form or with minor modifications. Based on this reasoning, the properties of bio-oil are often compared to that of petroleum crude oil. However, bio-oil has serious physical and chemical property issues and it is difficult to use it in existing petroleum refineries [15–18, 21–23].

Bio-oil is known to be extremely corrosive and this nature causes serious problems related to handling and transportation. The Total Acid Number (TAN) required for crude oil refineries is normally less than 2. Typical bio-oil TAN values range from 50 to as high as 200 [24]. Bio-oil typically contains 15–30% water. Besides water, components present in high concentrations are hydroxyl-acetaldehyde and acetic and formic acids. These oxygenated compounds along with various other species such as phenolic compounds contribute



toward the acidity of the bio-oil. Typical pH of the bio-oil is in the range of 2.0–3.0 [16]. The viscosity of bio-oils increases during storage and the physical properties undergo considerable changes [21]. The changes in the physical properties are attributed to the self-reaction of various compounds in the bio-oil including polymerization reactions [22, 25]. These reactions, occurring during storage, increase the average molecular weight of the bio-oil and also lead to other storage related issues such as phase separation.

The resulting corrosive nature presents serious obstacles to any efforts aimed at the transportation and centralized refining or upgrading of the bio-oils. Also, the unstable nature of bio-oils often necessitates minimizing storage times and local upgrading, instead of transportation to a centralized facility. Such local upgrading is done by means of hydro-deoxygenation using hydrogen, often in the presence of catalysts. This normally adds capital and operating cost to the bio-oil production process. Gasification and co-gasification of bio-crude to syngas have been tried, with reasonable success [5].

Most of the fast pyrolysis projects are still in laboratory scale with an exception of a few, including KIOR project [53] and BTG-BV in the Netherlands, which was originally developed by University of Twente [54]. These processes are regarded as pre-commercial, or demonstration stage technologies.

#### **4.4. Direct combustion**

Direct combustion of biomass is the oldest energy production process in human history. It is still by far the most widely used biomass conversion process. It is the most common biomass to power generation method commercially available [41]. The scale can be very small to relatively large, ranging from 1 MW up to 100 MW. Co-firing of biomass with coal is the effective way for lowering the greenhouse gas emissions. A wide range of technology options ranging from the simple fire stove to the advanced boiler system with fluidized furnace using pulverized fuel are available. Precise control of mixing between the biomass fuel and oxygen source (generally, air) is a critical aspect of advanced combustion systems in order to achieve improved thermal efficiency and minimize of criteria pollutant emissions including particulate matter (PM), nitrogen oxide (NO<sub>x</sub>), carbon monoxide (CO) and hydrocarbons.

For industrial and centralized domestic heat and power generation, several designs including stoker burners, grate boilers and/or dense fluid-bed combustor are used ranging from a few kilowatts to 10 MW. Combustion efficiency has improved remarkably in recent decades and has reached over 90% from around 55% in 1980 (FBC). Recently, development of combustion systems with pressurized fluidized beds have enabled direct electricity production without requiring steam generation, since process utilizes the fluidized bed as combustion chamber of the gas turbine [55].

For a very large-scale direct combustion (larger than 300 MW), co-firing biomass with pulverized coal has been recommended. Pulverized coal combustion technology is well established and co-firing is an attractive option that can reduce the carbon dioxide emissions

from coal. However challenges associated with co-firing with biomass such as changes in ash properties, fouling of heat exchanger, etc. still need to be addressed [56]. Biomass torrefaction is promising process that improves the usefulness of biomass as a fuel by heating the biomass in the absence of air under mild temperatures (230–300°C). The resulting biomass fuel is a desirable feedstock for entrained-flow reactors or in pulverized coal fired boilers with co-firing of biomass [57].

Arce et al., [58] studied the performance of the different types of biomass fuel combustion process in a counter-current fixed bed reactor in the temperature range of 740–1300°C to check the effects of different factors and find the optimum condition. According to the study, the ignition front propagation speed and the highest temperature that is reached at the fixed bed combustor affects the combustion process most.

Oxy-combustion is an emerging technology that uses pure oxygen in the combustor. The advantage is that after the cooling of flue gas, nearly pure carbon dioxide is produced without any nitrogen or nitrogen oxides. However, the use of pure oxygen (or oxygen enriched air) results in higher capital and operating costs. This needs to be balanced against the cost/energy savings related to carbon dioxide capture. This technology is still in the research and demonstration stage. As more cost effective processes for oxygen production such as membrane separation are developed, oxy-combustion will presumably become a more attractive option for both biomass and fossil feedstocks.

## 5. Conclusion

Energy sources from the renewable carbon are critical to address future energy needs, in the all energy consuming sector. Biomass is the largest and most widespread carbon source for producing renewable energy, fuels and chemicals and can be a constant, reliable resource compare to other renewable sources such as solar or wind energy. A wide range of biomass conversion processes are available and are under development. Among these, thermochemical processes offer several advantages, including product versatility, and high conversion rates and efficiencies, although challenges to commercialization still remain.

Wet thermochemical processes including hydrothermal conversion, supercritical gasification and steam hydrogasification are still under development, but have many attractive aspects for use in decentralized, low cost applications, especially for high moisture content biomass. Dry thermochemical conversion processes including direct combustion, gasification and pyrolysis have several specific technology options that are mature. However, economic viability issues and technical challenges related to tar formation and alkaline ash presence still need to be addressed.

New emerging approaches such as the bio-refinery concept which synergistically combines different conversion technologies and generate multiple products are expected to play a key role in addressing the technical and economic barriers of the current thermochemical biomass conversion processes.

## Author details

Chan Seung Park<sup>1\*</sup>, Partho Sarothi Roy<sup>1</sup> and Su Hyun Kim<sup>2</sup>

\*Address all correspondence to: [cspark@cert.ucr.edu](mailto:cspark@cert.ucr.edu)

1 College of Engineering - Center for Environmental Research and Technology, University of California, Riverside, CA, USA

2 Institute for Advanced Engineering, Yongin-si, Gyeonggi-do, Korea

## References

- [1] Perlack RD, Wright LL, Turhollow AF, Graham RL, Stokes BJ, Erbach DC. Biomass as Feedstock for a Bioenergy and Bioproducts Industry: The Technical Feasibility of a Billion-Ton Annual Supply. Oak Ridge, Tennessee: Oak Ridge National Laboratory; 2005. DOE/GO-102995-2135
- [2] Drift A. Role of gasification in a bio-based future. In: 24th European Biomass Conference and Exhibition; 1–4 June; Vienna, Austria; 2015. ISBN: ECN-L-15-063 EN
- [3] GREET by Argonne National Laboratory. The Greenhouse Gases, Regulated Emissions, and Energy Use in Transportation Model. Argonne, IL: GREET 1.8d.1 ed; 2010
- [4] Gaur S, Reed TB. Thermal Data for Natural and Synthetic Fuels. CRC Press: Marcel Dekker; 1998. pp. 102-108. ISBN 0-8247-0070-8
- [5] Higman C, van der Burgt M. Gasification. Gulf Professional Publishing: Elsevier Science; 2011. 33, 167-173 p. ISBN 978-0-7560-8528-3
- [6] Milena Indirect Gasifier. MILENA Biomass Gasification Process [Internet]. 2017. Available from: <http://www.milenatechnology.com> [Accessed: 2017-08-01]
- [7] Peer M, Mahdeyarfar M, Mohammadi T. Investigation of syngas ratio adjustment using a polyimide membrane. Chemical Engineering and Processing Process Intensification. 2009;**48**(3):755-761. DOI: 10.1016/j.cep.2008.09.006
- [8] Öhrman OGW, Weiland F, Pettersson E, Johansson A-C, Hedman H, Pedersen M. Pressurized oxygen blown entrained flow gasification of a biorefinery lignin residue. Fuel Processing Technology. 2013;**115**:130-138. DOI: 10.1016/j.fuproc.2013.04.009
- [9] Patel M, Zhang X, Kumar A. Techno-economic and life cycle assessment on lignocellulosic biomass thermochemical conversion technologies: A review. Renewable and Sustainable Energy Reviews. 2016;**53**:1486-1499. DOI: 10.1016/j.rser.2015.09.070
- [10] Swaaij W, Kersten S. Biomass Power for the World. CRC Press: Pan Stanford Publishing; 2015. p. 33. ISBN 978-981-4669-24-5

- [11] Bergius FKR. Die Anwendung hoher Drucke bei chemischen Vorgängen und eine Nachbildung des Entstehungsprozesses der Steinkohle. Halle, Germany: Verlag Wilhelm Knapp. 1912; [http://www.nobelprize.org/nobel\\_prizes/chemistry/laureates/1931/bergius-lecture.pdf](http://www.nobelprize.org/nobel_prizes/chemistry/laureates/1931/bergius-lecture.pdf) [Accessed: 2015-12-04]
- [12] Peterson AA, Vogel F, Lachance RP, Fröling M, Antal MJ Jr, Tester JW. Thermochemical biofuel production in hydrothermal media: A review of sub- and supercritical water technologies. *Energy & Environmental Science*. 2008;**1**(1):32-65. DOI: 10.1039/b810100k
- [13] Yang YF, Feng CP, Inamori Y, Maekawa T. Analysis of energy conversion characteristics in liquefaction of algae. *Resources, Conservation and Recycling*. 2004;**43**(1):21-33. DOI: 10.1016/j.resconrec.2004.03.003
- [14] Chen WH, Lin BJ, Huang MY, Chang JS. Thermochemical conversion of microalgal biomass into biofuels: A review. *Bioresource Technology*. 2015;**184**:314-327. DOI: 10.1016/j.biortech.2014.11.050
- [15] Hoffmann J. Upgrading of bio-crude from hydrothermal liquefaction. In: TCBIomass. 2013; or <http://www.steeperenergy.com>
- [16] Toor SS, Rosendahl L, Nielsen MP, Glasius M, Rudolf A, Iversen SB. Continuous production of bio-oil by catalytic liquefaction from wet distiller's grain with solubles (WDGS) from bio-ethanol production. *Biomass and Bioenergy*. 2012;**36**:327-332. DOI: 10.1016/j.biombioe.2011.10.044
- [17] Berends RH, Zeevalkink JA, Naber JE. Results of the first long duration run of the HTU pilot plant at TNO-MEP. In: *Proceedings of the 2nd World Biomass Conference: Biomass for Energy, Industry and Climate Protection*; Rome; 2005. p. 535
- [18] Elliott DC, editor. *Hydrothermal Processing in Thermochemical Processing of Biomass: Conversion into Fuels, Chemicals and Power*. Chichester, UK: John Wiley and Sons; 2011. pp. 200-231
- [19] Demirbas A. Hydrogen production from biomass via supercritical water gasification. *Energy Sources, Part A: Recovery, Utilization, and Environmental Effects*. 2010;**32**(14): 1342-1354. DOI: 10.1080/15567030802654038
- [20] Gadhe JB, Gupta RB. Hydrogen production by methanol reforming in supercritical water: Catalysis by in-situ-generated copper nanoparticles. *International Journal of Hydrogen Energy*. 2007;**32**(13):2374-2381. DOI: 10.1016/j.ijhydene.2006.10.050
- [21] Dinjus E, Kruse A. Hot compressed water—A suitable and sustainable solvent and reaction medium. *Journal of Physics. Condensed Matter*. 2004;**16**(14):S1161-S1169. DOI: 10.1088/0953-8984/16/14/026
- [22] Marrone PA, Hong GT. Corrosion control methods in supercritical water oxidation and gasification processes. In: *NACE International, editor. Corrosion*. New Orleans; 2008

- [23] Antal MJ, Allen SG, Schulman D, Xu X, Divilio RJ. Biomass gasification in supercritical water. *Industrial and Engineering Chemistry Research*. 2000;**39**(11):4040-4053. DOI: 10.1021/ie0003436
- [24] Knezevic D. Hydrothermal conversion of biomass [thesis]. Ipskamp Drukkers B.V: Enschede; 2009. ISBN: 978-90-365-2871-9
- [25] Fritz R. KIT-IKFT-VERENA Pilot Plant [Internet]. Available from: <http://www.ikft.kit.edu/english/138.php>. [Accessed: 2015-07-16]
- [26] Hydrogasification/FT Production with Electricity & Electricity Only Cases CERT-1 thru CERT-6 Conceptual Study, [Internet]., DOE-NETL, 2010. Available from: <http://www.netl.doe.gov/research/coal/energy-systems/gasification/gasifiedia/hydro>. [Accessed: 2016-08-15]
- [27] Mozafarrian M, Zwart R. Production of Substitute Natural Gas by Biomass Hydrogasification. Petten: Netherlands Energy Research Foundation, (ECN); 2000. ECN-RX-00-38
- [28] Jeon SK, Park CS, Hackett CE, Norbeck JM. Characteristics of steam hydrogasification of wood using a micro-batch reactor. *Fuel*. 2007;**86**(17-18):2817-2823. DOI: 10.1016/j.fuel.2007.03.023
- [29] Raju ASK, Park CS, Norbeck JM. Synthesis gas production using steam hydrogasification and steam reforming. *Fuel Processing Technology*. 2009;**90**(2):330-336. DOI: 10.1016/j.fuproc.2008.09.011
- [30] Cui H, Turn SQ, Keffer V, Evans D, Tran T, Foley M. Contaminant estimates and removal in product gas from biomass steam gasification. *Energy & Fuels*. 2010;**24**(2):1222-1233. DOI: 10.1021/ef9010109
- [31] Park C, Norbeck JM. Development of Steam Hydrogasification Process Demonstration Unit-5 Lb/Hr PDU Design Report. Sacramento, CA: California Energy Commission; 2011. DOI: CEC-500-2013-092
- [32] Rezaian J, Cheremisinoff NP. *Gasification Technologies: A Primer for Engineers and Scientists*. CRC press; 2005. ISBN: 978-0-82-472247-0
- [33] Basu P. *Biomass Gasification and Pyrolysis: Practical Design and Theory*. Academic Press: Elsevier Science; 2010. p. 167. ISBN: 978-0-12-374988-8
- [34] Pröll T, Rauch R, Aichernig C, Hofbauer H. Fluidized bed steam gasification of solid biomass: Analysis and optimization of plant operation using process simulation. In: 18th International Conference on Fluidized Bed Combustion; ASME; 2005. pp. 763-770. DOI: 10.1115/FBC2005-78129
- [35] Van der Meijden CM, Veringa HJ, Van der Drift A, Vreugdenhil BJ. The 800 kWth allothermal biomass gasifier MILENA. In: 16th European Biomass Conference and Exhibition. Valencia, Spain; 2008

- [36] Yan C et al. A novel biomass air gasification process for producing tar-free higher heating value fuel gas. *Fuel Processing Technology*. 2006;**87**(4):343-353. DOI: 10.1016/j.fuproc.2005.10.003
- [37] Zhou J, Chen Q, Zhao H, Cao X, Mei Q, Luo Z, Cen K. Biomass–oxygen gasification in a high-temperature entrained-flow gasifier. *Biotechnology Advances*. 2009;**27**(5):606-611. DOI: 10.1016/j.biotechadv.2009.04.011
- [38] Huber GW, Iborra S, Corma A. Synthesis of transportation fuels from biomass: Chemistry, catalysts, and engineering. *Chemical Reviews*. 2006;**106**(9):4044-4098. DOI: 10.1021/cr068360d
- [39] Knoef HAM, editors. *Handbook of Biomass Gasification*. 2nd ed. Netherlands: BTG Biomass Technology Group BV; 2012. Available from: <http://www.btgworld.com/en/references/publications/handbook-biomass-gasification-second-edition> [Accessed: 2015-12-05]
- [40] Bridgwater AV, Boocock DGB, editors. *Cleaning of Hot Producer Gas in a Catalytic Adiabatic Packed Bed Reactor With Periodic Flow Reversal, Development in Thermochemical Biomass Conversion* Dordrecht. Netherlands: Springer; 1997. pp. 907-920. DOI: 10.1007/978-94-009-1559-6
- [41] Van de Kaa G, Kamp L, Rezaei J. Selection of biomass thermochemical conversion technology in the Netherlands: A best worst method approach. *Journal of Cleaner Production*. 2017;**166**:32-39. DOI: 10.1016/j.jclepro.2017.07.052
- [42] Aichering Ch. Indirect Gasification. 2011. [Internet]. Available from: [http://www.marcogaz.org/egatec2011/PS2/PS2Eb\\_Aichernig\\_egatec2011.pdf](http://www.marcogaz.org/egatec2011/PS2/PS2Eb_Aichernig_egatec2011.pdf) [Accessed: November 29, 2017]
- [43] Zweiler R. Best Practice Wood Gasification for CHP. 2011. [Internet]. Available from: <http://abina.biomasseverband.at/de/veranstaltungen/tagungen-und-vortraege/archiv/cross-border-bioenergy-workshop/chp-workshop/> [Accessed: November 29, 2017]
- [44] Zwart RWR. Synthetic Natural Gas. Large-Scale Introduction of Green Natural Gas in Existing Gas Grids (No. ECN-L-07-069). Energy Research Centre of the Netherlands ECN. 2007. [Internet]. Available from: <ftp://ftp.ecn.nl/pub/www/library/report/2007/107069.pdf> [Accessed: November 29, 2017]
- [45] Zwart RWR, Boerrigter H, Deurwaarder EP, Van der Meijden CM, Van Paasen SVB.. Production of synthetic natural gas (SNG) from biomass. Energy Research Centre of the Netherlands (ECN). 2006. [Internet]. . Available from: <https://www.ecn.nl/docs/library/report/2006/e06018.pdf> [Accessed: November 29, 2017]
- [46] Bengtsson K. Twin-Bed Gasification Concepts for Bio-SNG Production. Lund Institute of Technology, Department of Chemical Engineering, Lund, Sweden. 2007. [Internet]. Available from: <http://www.chemeng.lth.se/exjobb/E450.pdf> [Accessed: November 29, 2017]
- [47] Ahrenfeldt J, Jørgensen B, Thomsen T. Bio-SNG Potential Assessment: Denmark 2020. Risø Nationallaboratoriet for Bæredygtig Energi: Danmarks Tekniske Universitet; 2010. [Internet]. Available from: <orbit.dtu.dk/files/5237878/ris-r-1754.pdf> [Accessed: November 29, 2017]

- [48] Hdenskog M. The GoBiGas-Project Gasification to Produce High-Quality Biogas. [Internet]. Available from: [http://www.vtt.fi/files/projects/vetaani/malin\\_hedenskog.pdf](http://www.vtt.fi/files/projects/vetaani/malin_hedenskog.pdf) [Accessed: November 29, 2017]
- [49] Scott D, Piskorz J. The flash pyrolysis of aspen-poplar wood. *The Canadian Journal of Chemical Engineering*. 1982;**60**(5):666-674. DOI: 10.1002/cjce.5450600514
- [50] Pan P, Hu C, Yang W, Li Y, Dong L, Zhu L, Fan Y. The direct pyrolysis and catalytic pyrolysis of *Nannochloropsis* sp. residue for renewable bio-oils. *Bioresource Technology*. 2010;**101**(12):4593-4599. DOI: 10.1016/j.biortech.2010.01.070
- [51] Isahak WNRW, Hisham MW, Yarmo MA, Hin TYY. A review on bio-oil production from biomass by using pyrolysis method. *Renewable and Sustainable Energy Reviews*. 2012;**16**(8):5910-5923. DOI: 10.1016/j.rser.2012.05.039
- [52] Duman G, Okutucu C, Ucar S, Stahl R, Yanik J. The slow and fast pyrolysis of cherry seed. *Bioresource Technology*. 2011;**102**(2):1869-1878. DOI: 10.1016/j.biortech.2010.07.051
- [53] KiOR, Inc. - Home. Inaeris Technologies [Internet]. Available from: <http://www.kior.com/> [Accessed: 2017-02-01]
- [54] Wagenaar BM, Prins W, Van Swaaij WPM. Pyrolysis of biomass in the rotating cone reactor: Modelling and experimental justification. *Chemical Engineering Science*. 1994;**49**(24):5109-5126. DOI: 10.1016/0009-2509(94)00392-0
- [55] Huang Y, McIlveen-Wright D, Rezvani S, Wang YD, Hewitt N, Williams BC. Biomass co-firing in a pressurized fluidized bed combustion (PFBC) combined cycle power plant: A techno-environmental assessment based on computational simulations. *Fuel Processing Technology*. 2006;**87**(10):927-934. DOI: 10.1016/j.fuproc.2006.07.003
- [56] Loo S, Koppejan J. *Biomass Power for the World*. CRC Press: Pan Stanford Publishing; 2015. pp. 248-264. ISBN 978-981-4669-24-5
- [57] Bach QV, Skreiberg Ø. Upgrading biomass fuels via wet torrefaction: A review and comparison with dry torrefaction. *Renewable and Sustainable Energy Reviews*. 2016;**54**:665-677. DOI: 10.1016/j.rser.2015.10.014
- [58] Arce ME, Saavedra Á, Míguez JL, Granada E, Cacabelos A. Biomass fuel and combustion conditions selection in a fixed bed combustor. *Energies*. 2013;**6**(11):5973-5989. DOI: 10.3390/en6115973

